

# What is Wrong with Current Physics.

Leo Vuyk,  
Architect, the Netherlands.

## Abstract,

The Q-FFF Theory based Herbig Haro dual black hole interpretation seems to be responsible for new physics forming massive Fermions out of the vacuum.

The forgotten Hawking Penrose Black Hole is assumed to change our physical life as a whole. Matter production out of the vacuum Axion string particles is supposed to be obtained by the Penrose “Trapped Space Surfaces” around Black Holes.

In combination with Q-FFF Theory and Axion-Higgs collision at the BH horizon, oscillating compressed vacuum, creates fermion Pair production and even repelled charged plasma, forming accelerating black hole plasma tails.

As a consequence the Big Bang is not assumed to be Hot, but a cold explosion of Axion evaporating chunks of string based dark matter black holes, which became responsible for mass/fermion production out of the vacuum.

Recently Roger Penrose did speak about the logic of so called trapped space surfaces around black holes in his Noble speech which is supposed to be the same as the light horizon in Q-FFF Theory. ( Function Follows Form of real strings)

## New Physics:

1: There seem to be TWO different black holes: small (by magnetic interference) and large ( by star matter implosion).

a: small interference black holes ( sunspots comets and even magnetic interference ball lightning)

b: supernova black holes by implosion of stars, larger than the sun.

2: Fermions seem to have a propeller shape with left or right pitch for different charge and spin.

3: Magnetic- and electric fields seem to include monopole particles ( respectively North South, or plus and minus)

4: Spinning Fermions produce monopole photons anti-gravitons e.m. Monopoles and electron/positron monopoles, by collision of the oscillating vacuum particle.

5: Each string has at least one super symmetric mirror particle connected by long distance wormholes between mirror symmetric raspberry shaped multiverses.

6: Both Black Holes a and b, repel fermions and create fermion pairs at their light

horizon, which is the same as the Trapped Space Surface mentioned in his Nobel speech in 2020.

Free Energy from the vacuum between two new physics black holes is found in Herbig Haro systems and around all stars called Birkeland Currents.

Based on the new dual string knot black hole interpretation of Q-FFF Theory, It is a logic proposal that future Herbig Haro micro ball lightning black hole systems will produce most of our need for electric energy.

In contrast with the evaporating black hole suggested by S. Hawking, all Black Holes grow, only by eating other black holes, vacuum particles (dubbed Axion-Higgs), all radiation and Neutrinos. However, BHs, do NOT eat Fermions.

The smallest BHs (Ball Lightning) are unstable, but need radiation support to stay stable.

Large (M87) black holes are observed with rings of plasma which is not eaten by the black hole, but distributed as Fermi bubbles perpendicular to the plane of the Galaxy. However equal sized black holes do repel each other, often leaving a plasma bar in between, as the start of a celestial object. Like a star later a Galaxy or failed star dependent of the scale of the Herbig Haro system.

## **Introduction.**

In Quantum FFF Theory, Fermions are supposed to be small rigid transformer strings with a propeller shape, able to become compound particles with photons, to form Quarks.

Different elementary particles have different qualities by their different complex stringy shape. Leptons and Quarks have a propeller shape with left or right handed pitch creating charge difference. Gluons, Photons and Neutrino particles have no comparable pitch.

The rigid FORM and Microstructure of elementary particles (rigid strings), is supposed to be the origin of functional differences between Higgs- Graviton- Photon- and Fermion particles.

As a consequence, a new splitting, accelerating and pairing new paradigm Dark Matter Black Hole, (DMBH) seem to be able to convert vacuum particle energy (ZPE) into real plasma which could explain quick Galaxy- and Star formation, by so called Galaxy- or Stellar Anchor Black Holes (GABHs respectively SABHs).

These Anchor Black Holes can be observed as Herbig Haro ( HH) Hotspots or Bowshocks.

Recent observation of two High Energy Cosmic Ray Hotspots, (HECRHs) at solar polar locations, ( Big Dipper and Southern cross) is reason to assume in accord with new physics of Quantum FFF Theory, that these hotspots represents the locations of our Solar Anchor Black Hole (the North-and South SABHs).

At the same time in the Quantum FFF model, it is proposed that early Galaxies also are created by dual black hole ( HH) systems being former Big Bang black hole splintered primordial dark matter black holes.

They will be called Galaxy Anchor Black Holes ( GABHs)

As a consequence, the standard Hot Big Bang with Hot plasma and Hydrogen as the base for everything has to be rejected.

Recent observation of a faint galaxy without a dark matter content (NGC 1052 DF2) seems to be created by the star forming capacity even by triple pairing dark matter black hole nuclei,

located in the center of the surrounding globular star clusters assumed to have a triangular topology.

New Herbig Haro Physics is supposed to be obtained by the architecture of Quantum FFF (Function Follows Form) Theory.

### **Could we live in a rigid string based entangled symmetrical multiverse?**

Characteristics:

1: The clear MICROSTRUCTURE or the 3D FORM of rigid elementary particles, (also called 3DPreons) made out of convertible Higgs particles, is responsible for “Bound states of Fermions” and composite Quarks.

2: A massless Axion Higgs particle is supposed to be energetic oscillating, it is the origin all particle motion and spin states and Dark energy inside a truncated tetrahedron shaped chiral vacuum lattice. The lattice chirality (left or right handed) is the origin of our material universe. Axion-Higgs particles are zero point “Planck Oscillators” the origin of the Casimir force, waiting to be harnessed as free energy.

3: Nothing sucks in physics, Gravitons act with less pressure on Fermions than the Axion Higgs vacuum (dark energy) and everything is entangled by instant communication between at least two anti-copy universe or Raspberry multiverse, being entangled since the big bang. 4: Black holes of all sizes (down to interference black holes like ball lightning) do not emit gravitons, they feel only Casimir Gravity of the vacuum oscillations so they are massless but counter intuitively the origin of dark matter and producers of all Hydrogen by electron and Positron pairs as horizon fluctuations and repel all Fermionic plasma at the BH horizon accelerated by the negative charged electron shell around each black hole..

5: The Multiverse is Pulsating by two phenomena,

A; vacuum (Higgs) eating new paradigm dark matter black holes (causing the Hubble redshift)  
B: by universal expansion caused by the oscillation vacuum force (Dark energy) of the Axion Higgs vacuum lattice.

FUNCTION FOLLOWS FORM in Quantum FFF-Theory. The Microstructure of elementary particles, is supposed to be the origin of functional differences between Higgs- Photon- and propeller shaped Fermion particles.

Something small is missing in mainstream physics: a NEW splitting and pairing

Massless black hole, the origin of all dark matter, Ball Lightning Micro Comets , Comets, Sunspots up to Galaxy external Anchor Black Holes and the Big Crunch of the CP symmetric pulsating raspberry shaped multiverse.

The multiverse can be compared with a huge pinball machine, with dark energy in the form of linear oscillating double Higgs pins as the origin of photonic collision products with the propeller shaped Fermions as balls. All forces are the result of this entangled Pin-Ball interaction.

The 125GeV Higgs Boson recently found in the LHC is assumed to be not a single but a threefold knot of monopole magnetic particles ( North or South).

The 125GeV energy is the base for universal dark energy, the frequency is the base for local time and the length a base for the Planck scale. (Twin Higgs, Dual Higgs, Duplex Higgs, or Tandem Higgs)

As a result, an unstable Higgs vacuum seems to be present around all black hole horizons due to observed H2 plasma production and annihilation radiation created by pair production of positrons and electrons. (Instability of the Higgs field)

The Lyman alpha Structure of the universe seems to be the result of the H<sub>2</sub> production and black hole splitting process, which seems to be supported by the recently observed huge Quasar Groups found by R. Clowes, et al. (Ref: 96) and the recent UHECR ( Ultra High Energetic Cosmic Rays) observations from the Pierre Auger Observatory.(Ref. 97.) Consequently this seems to be a new support to consider new astrophysical models such an alternative Big Bang black hole splitting process.

## Quantum FFF Physics.

Quantum FFF theory states, that the vacuum is seeded with fast oscillating massless AxionHiggs particles, oscillating along a complex chiral tetrahedral vacuum lattice, which has the ability to transfer Photon and Graviton FORM information in bunches of oscillations, through the vacuum lattice with the local speed of light. As a consequence there are no attraction forces on propeller shaped Fermions. Gravity seems to be the result of two different impulse arrays: the massless Axion-Higgs impulse array and the opposing (less effective) massless Graviton impulse array.

As a consequence Black holes suffer only Higgs impulses and NO gravitons are escaping because the nucleus of the black hole is supposed to be a super dense knot of real rigid Axion Higgs particles. Only the statistical sum of the different kinds of vacuum impulses from all directions on Fermions are responsible for all (energetic) phenomena in the universe. The accelerating plasma tail of NEW paradigm black holes, and the splitting black holes by smaller pairing black holes is supposed to be the origin of a smooth proliferation of black holes in the universe. The Eagle Spire Nebula, (fig. 7) the Carina and other nebulas, are examples of a smooth proliferation of black holes through Galaxies and Nebula. What we can observe in these nebulas is the pairing and splitting of black holes ending up into multiple Herbig Haro objects as the origin of new stars as the start of small open star clusters..

Our sun is supposed to be also a remnant of a former open star cluster located in between two Stellar Anchor black holes, representing the so called hotspots of a former Herbig Haro object. ( figure 1 and 3)

The solar planetary system and planets are supposed to be expelled from the ever growing Sun by instable stellar rotation effects.

As a result we may discriminate two different kinds of stars:

Stars accompanied by two or even more Stellar Anchor Black holes ( SABHs) and stars that are not.

As a result we may observe clear differences in the way stars form planetary nebula at the end of their life.

There are Planetary Nebula's (PNs) with and without clear hotspots located on both sides of the symmetrical exploded gas distribution.

Next pages should give visual support for these statements.

See: Possible design of a micro electric Birkeland current production device for free energy.

The Trapped vacuum surface is supposed to be a real vacuum string collider creating pairs of fermions.

A brief definition of the Quantum FFF Theory or TOE.

( Function Follows Form of real primordial strings)

1: There seem to be TWO different black holes,

a: small interference black holes ( sunspots comets and even ball lightning)

b: supernova black holes by implosion of stars, growing larger BHs after merging ( up to the big Crunch).

2: Fermions seem to have a propeller shape with left or right pitch for different charge and spin.

3: Magnetic- and electric fields seem to include monopole particles ( respectively North South, or plus and minus)

4: Fermions produce monopole photons by collision of oscillating vacuum particle.

5: Each string has at least one symmetric particle connected by long distance wormholes (ER+EPR) to form the mirror symmetric raspberry shaped multiverse.

6: Both Black Holes repel fermions and create fermion pairs by vacuum collisions at their light horizon.

see: <https://bigbang-entanglement.blogspot.com/>

Hairy Gravity around planets and stars, by the internal dark matter black hole based crashed comets, with P-Wave ellipse. according to Q-FFF Theory.

According to the Quantum-FFF model, (Function Follows Form) Microscopic Dark Matter (singularity black holes) are proliferated inside stars (sunspots), comets and ball lightning. Recent study (B. Harris) suggest, that also around earth an equatorial dark matter ring is present as the origin of the "Flyby anomaly". However a DM equatorial disc located inside the earth (like sunspots) could solve the Flyby anomaly better and perhaps even the so called P-Wave shadow zone.

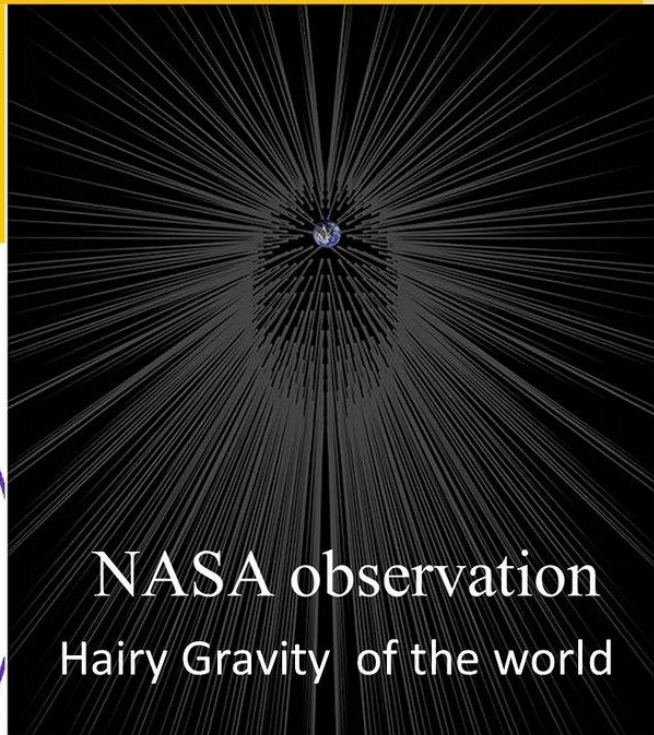
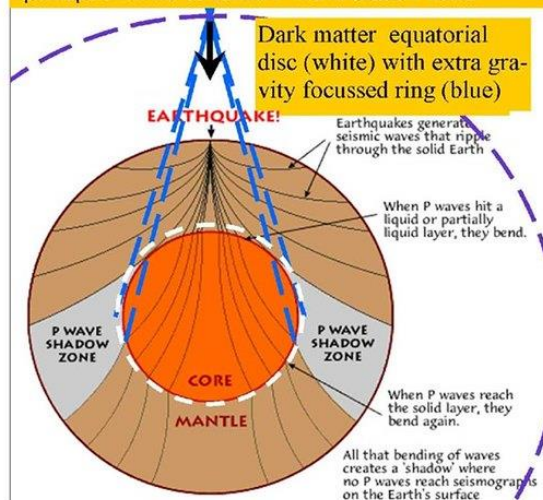

Figure 1,

Fermion Propeller Creation and Repulsion by the Trapped Space Surface.  
 With charge splitting Around a Black Hole due to the chiral oscillating String vacuum (Comparing Q-FFF Theory (left) and CCC of Penrose (right) )

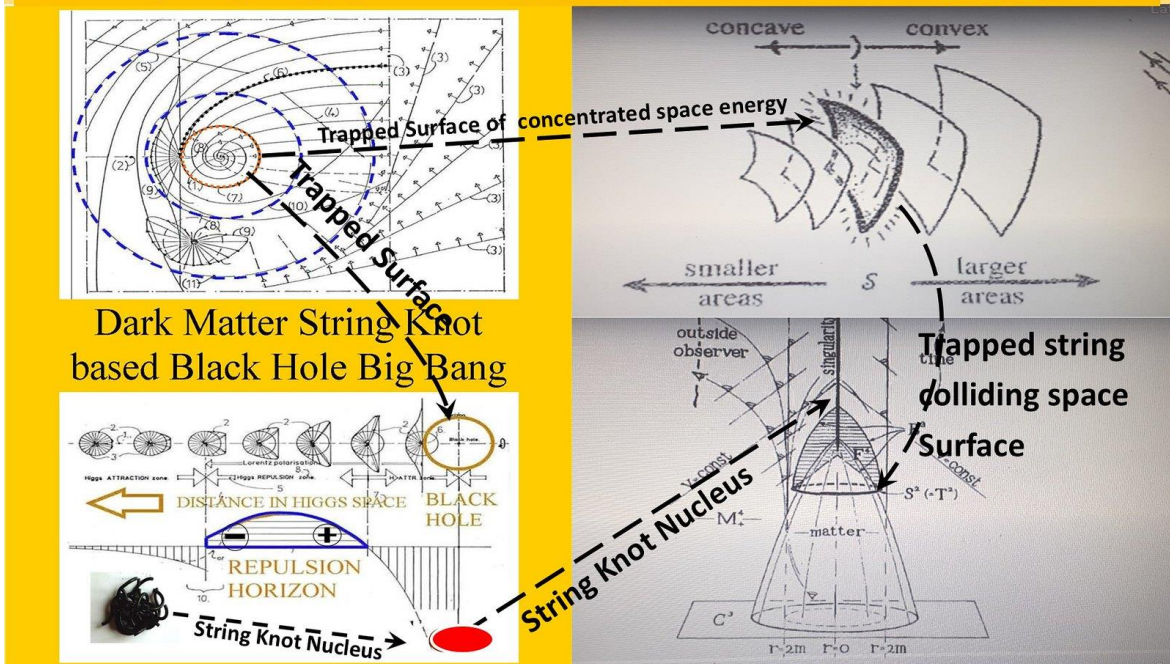

Figure 2.

Ejected interference Starspot black holes of equal size form small Herbig Haro systems

### Multiple Horizons created around Supernova Black Holes.

Proposal for the relation between different S-Nova shapes and the external primordial black hole configuration called Herbig Haro hotspot or Stellar Anchor Black Holes (SABHs)

Different Super Nova shapes are created around two star types:  
 A: Stars with distant "dual or quadrupole Stellar Anchor Black Holes" assumed to be located in the center of a former open star cluster. ( SN1987, NGC2440, Crab Nebula)  
 B: stars without SABHs. (SN1572) Our sun is equipped with two sunspot rings assumed to be of type A, with two SABHs, according to Quantum Function Follows Form Theory.

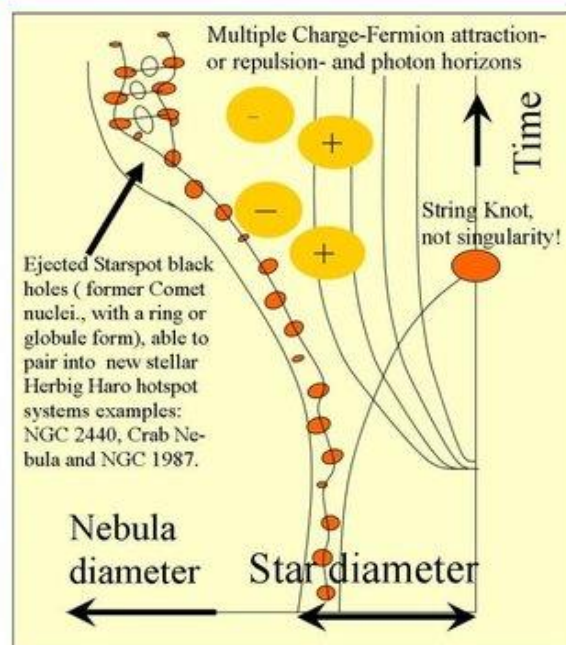
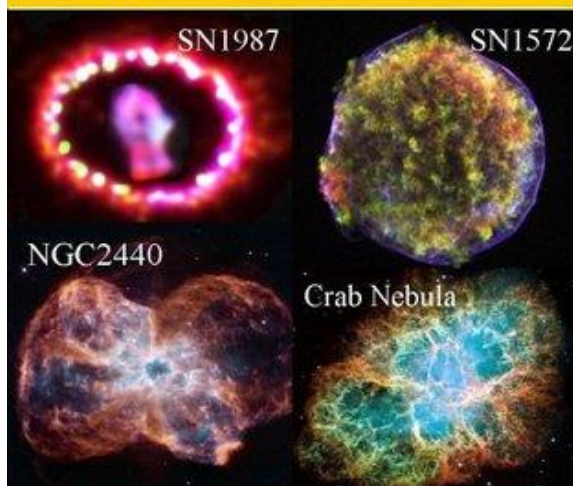
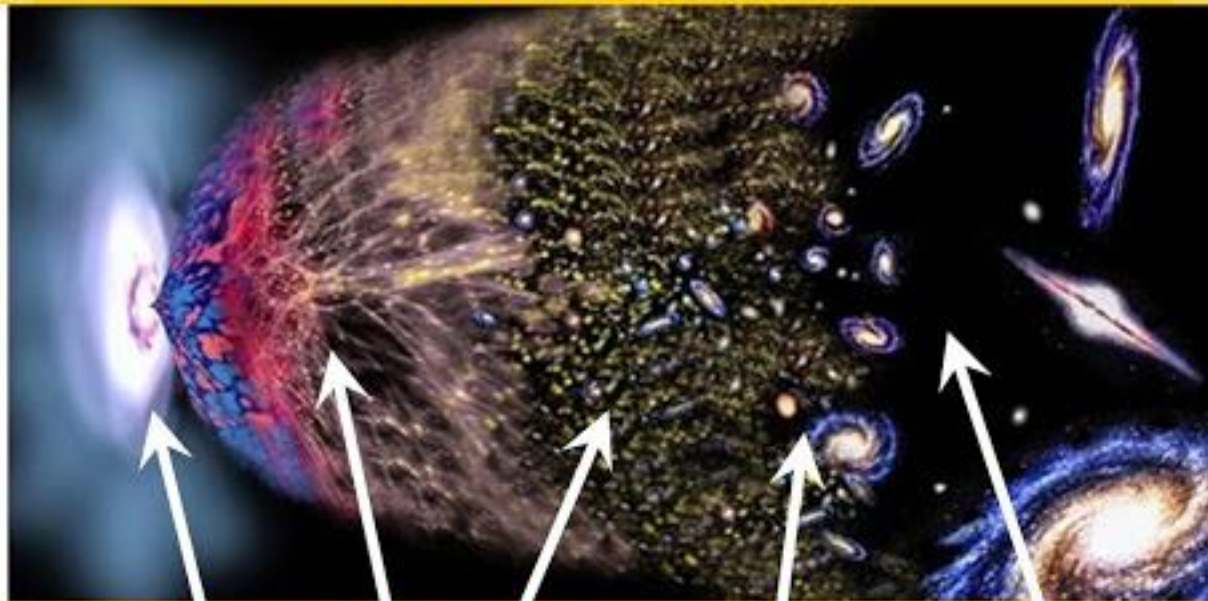

Figure 3.

# An new image of the String Knot Dark Matter Black Hole Big Bang explosion

Made by NikHef with an alternative cold Dark Matter Black Hole Big Bang, in line with Q-FFF Theory. ( below)



Big Bang/ String Knot Black Holes/ Dual Herbig Haro Black Holes/ Stars / Galaxies

evaporation process, according to Quantum FFF Theory

**Multi Bangs for Dual Symmetric Universes**

Dual Quasars /Herbig Haro ( Galaxy/ Stellar Anchor BHs)

Big Bang BH Splinters

Herbig Haro system

Dual Galaxy Anchor BHs

Galaxy Central BHs growing by merger BHs of S-Novas as a start of a contracting Universe into a Big Crunch.

"Big Bang Inflation" of the Universe: the Origin of Planets and Stars

New oscillating Axion -Sigma vacuum lattice

Empty space

Herbig Haro systems

The origin of the Cosmic Microwave Background (CMB) radiation is traced back to the formation of the first stars (Population III) in the early universe. These stars, which were the first to form, had a mass of approximately 100 solar masses and lived for only a few million years before exploding as supernovae. The energy from these explosions, along with the energy from the first stars, is thought to have heated the CMB. The CMB is now a uniform field of radiation that fills the universe, and its temperature is approximately 2.7 Kelvin. The CMB is a key piece of evidence for the Big Bang theory, and its study has led to a better understanding of the early universe.

Cygnus A with dual plasma/gas producing "New physics" negative charged BHs as hotspots, with growing merger (SN) black hole in the center. Below: local Quantum vacuum push gravity vector butterflies originated by the BH vacuum absorption of dark vacuum energy.

Electron-ion jet

Electron-ion jet

Fermion repelling Black hole horizon

Vacuum Push Gravity Butterfly curves around test masses.

Figure 4

LIGO based Black Hole ratios and the ability to merge or split into two equal BH parts, able to create Herbig Haro systems and Gamma Ray Bursts. Such splitting systems are observed in the so called Spire part of the Eagle nebula.

The origin of Gamma Ray Bursts, by splitting black holes of different size, leaving three BHs behind. Two of them could form a Herbig Haro Object with a dumbbell structure. (Quantum FFF theory@Leo Vuyk).

Dual black hole merger nominal mass contents observed by LIGO in 2015 and 2016 resp. 29/36 and 7.5/14.2x sun masses. see: Quantum FFF Theory. The related ratios are:1/1.24 resp.1/1.9.

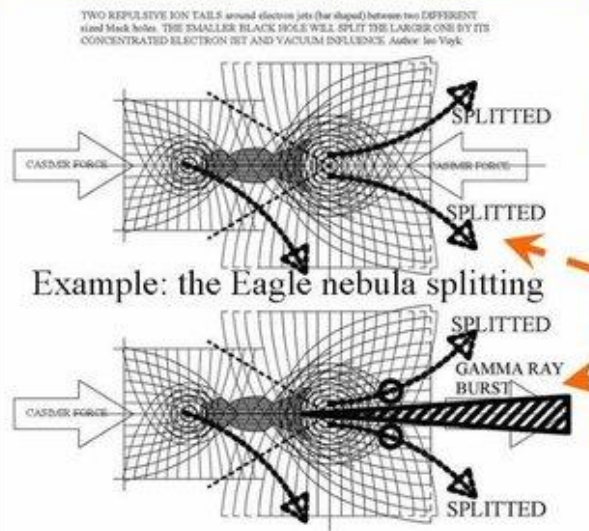

Example: the Eagle nebula splitting



2 LIGO ratios: 29-36/7,5-14.2sun= 1.0/1.24/1.9

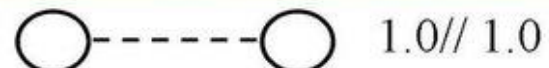

Herbig Haro creation ratio: 1x

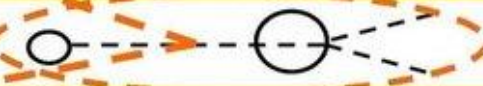

BH splitting ratio 1.0 >>> 1.9-?-50.0?

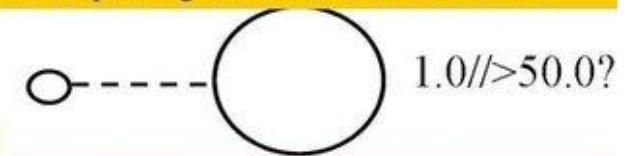

Small black holes should split larger BHs into two equal parts to create dual Herbig Haro hotspots also called bowshocks or accretion outburst sources.

Galaxy central BH merger: 1.0 //>50.0?

## Black hole splitting in the Spire Eagle nebula

According to the Quantum Function Follows Form Model, small black holes split larger BHs in equal halves, (A) which are able to repel each other and form Dumbbell shaped Herbig Haro systems (B,C) with star formation in between.

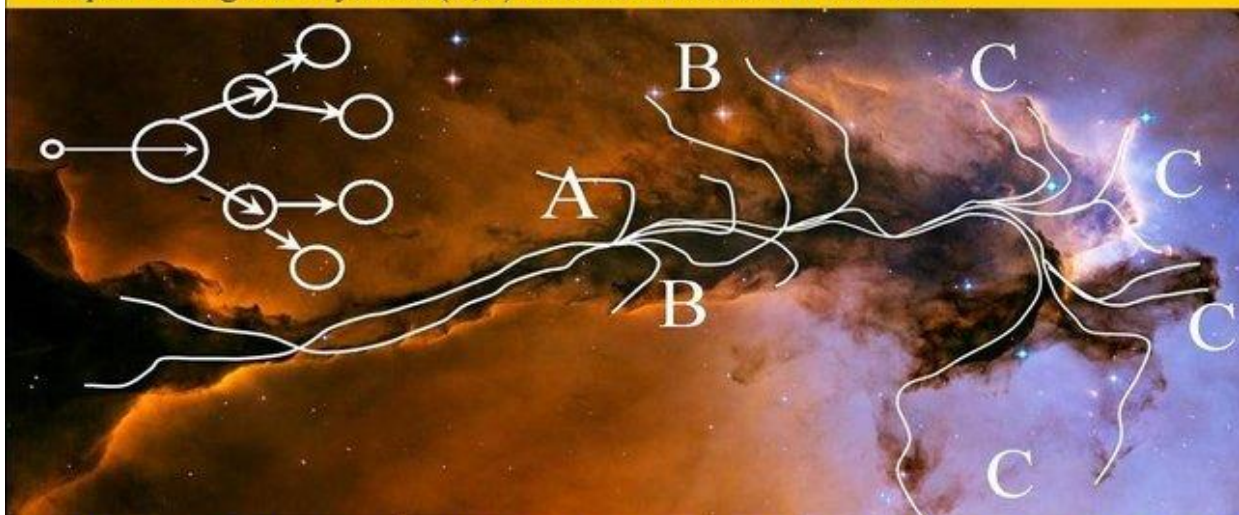

At location (A) both unequal sized black holes seem to split into 4x dual sets of smaller BHs one dual set has even evolved into a second 4x dual sets of BHs.

Figure 5,



# New support for a Fermion Repelling Black Hole. (Q-FFF Theory.)

## Meerkat observation of the Milky Way Center.

According to Quantum FFF Theory, The central giant MW-Black Hole only eat dual systems of smaller black holes, also called Herbig Haro systems. HH systems create plasma jets in between which seem to stay put (see: streaks) after both HH black holes are eaten by the central BH. The image (by MEERKAT) does already show some dual grouping HH systems without intermediate jets.



Evidence for a Fermion Repelling New Physics Black Hole inside Herbig Haro (HH34) Bowshock ! Outflow Velocity differences between the leading black hole and the secondary Fermion plasma hotspots are the indication, according to Q-FFF Theory.

The black hole (O) has the smallest relative velocity. Conclusion: Secondary Fermionic plasma hotspots are repelled ! As predicted!

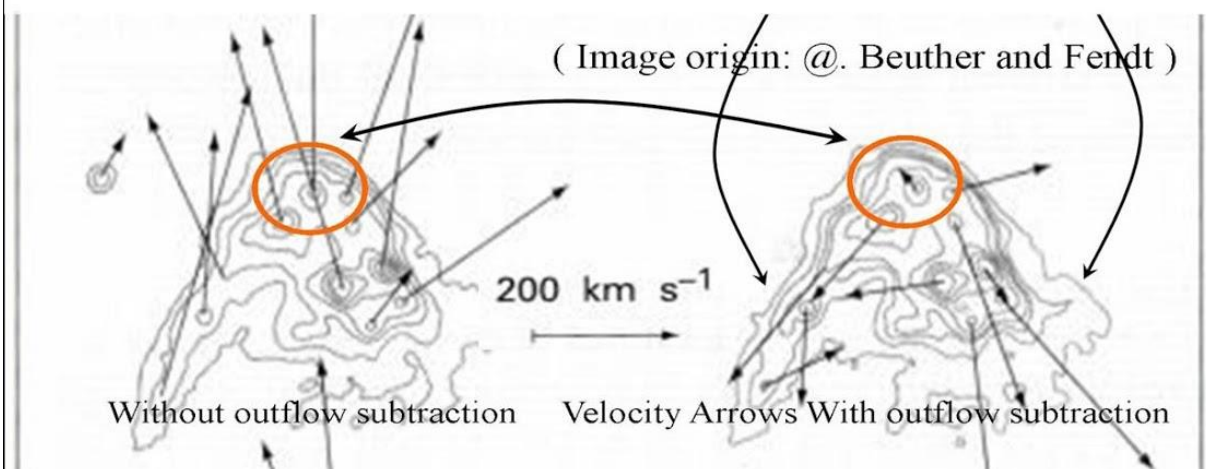
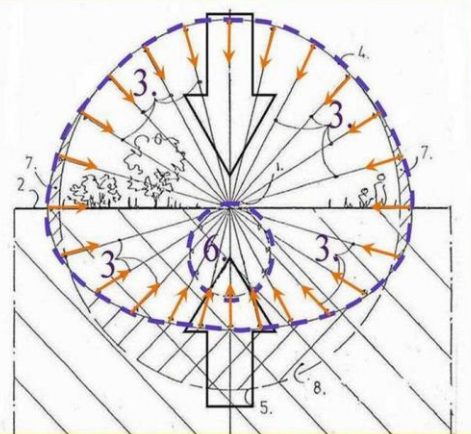

Figure 6,

Equivalence between gravity and acceleration does not hold in Quantum FFF Theory. Mass in motion needs a reference frame of ZPE oscillating Higgs field and Lorentz polarization of conscious propeller Fermions (s) to keep a non accelerated flight.

Quantum Gravity as pressure distribution of the oscillating dual Higgs/Graviton vector field.

Polarized Fermion Mass in motion through the resistive, but also pushing oscillating Higgs vacuum (according to Quantum FFF theory)



Cross section through the dual Higgs/ Graviton 3D vector field pressure distribution (or globular Hedgehog) on a point mass (1) located on earth's surface (2), according to Quantum FFF theory. 3+4= Higgs vector field. 6= Graviton vector field originated by the Higgs-graviton field transformation of the earth itself. 7+8= differences with a perfect globular vector distribution. Field variables 3+6 are rendered as inversed arrows. (see also black hole pressure distribution without gravitons)

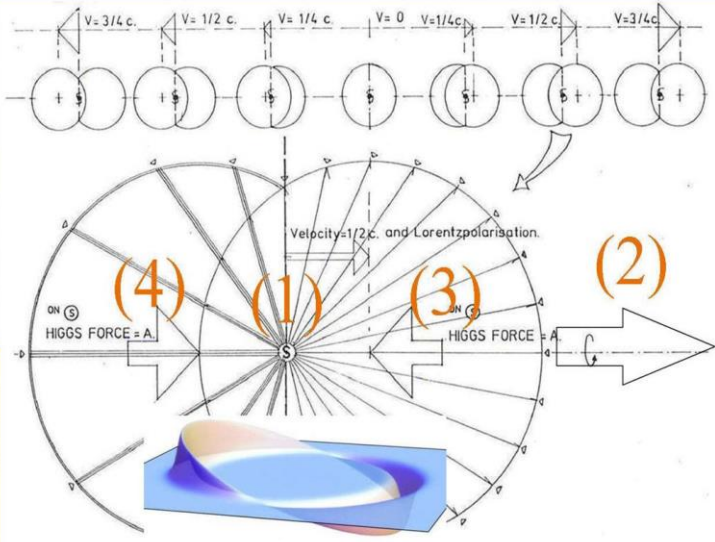
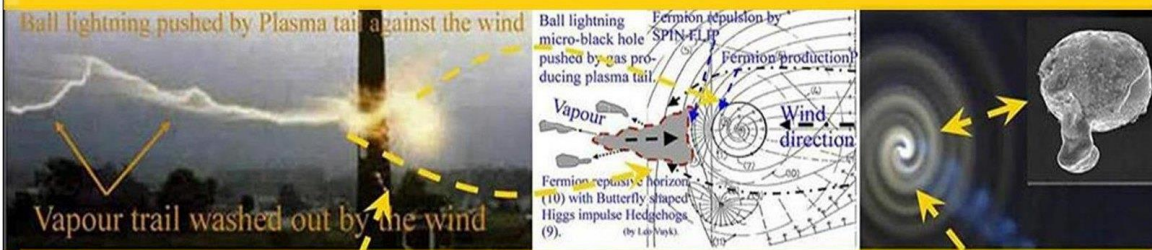

Figure 7,

### The New Physics of the Penrose-Q-FFF Black Hole with a Trapped Vacuum Collider Horizon, creating and repelling Fermion Matter.

Stable Micro Comets, Ball Lightning and WIMPs are the future solution for our CO2 problem, by electric vacuum energy production technology. [http://vixra.org/author/leo\\_vuyk](http://vixra.org/author/leo_vuyk)  
See: Artificial Ball Lightning production and exploitation device for Zero Point Electric Energy usage. <http://vixra.org/pdf/1108.0036v6.pdf> and <http://vixra.org/pdf/1404.0151v1.pdf>



Self propelled Ball Lightning-Micro Comets.

A Revolution in Physics and Community.



There are two production methods of Black Holes with the new physics Penrose-QFFF Fermion repelling horizon: A: Super Nova Black Holes. B: Micro Black Holes like Ball Lightning and Sunspots. (unstable respectively stable) by strong Magnetic Interference. Sunspots are assumed to be crashed Comet. (Fermion repelling Black Holes.) Future energy production for free, out of two Micro black holes like Herbig Haro star forming systems.

Figure 8,

Penrose's Trapped Surface able to repel all Fermions and make jets out of the Disc'.

Birkeland/ Aflven circuit currents around stars and galaxies, are driven by new paradigm tandem black holes, producing an external excess of negative charged plasma accelerated by the Casimir polarized vacuum (or Higgs polarized oscillations, according to Q-FFF Theory)

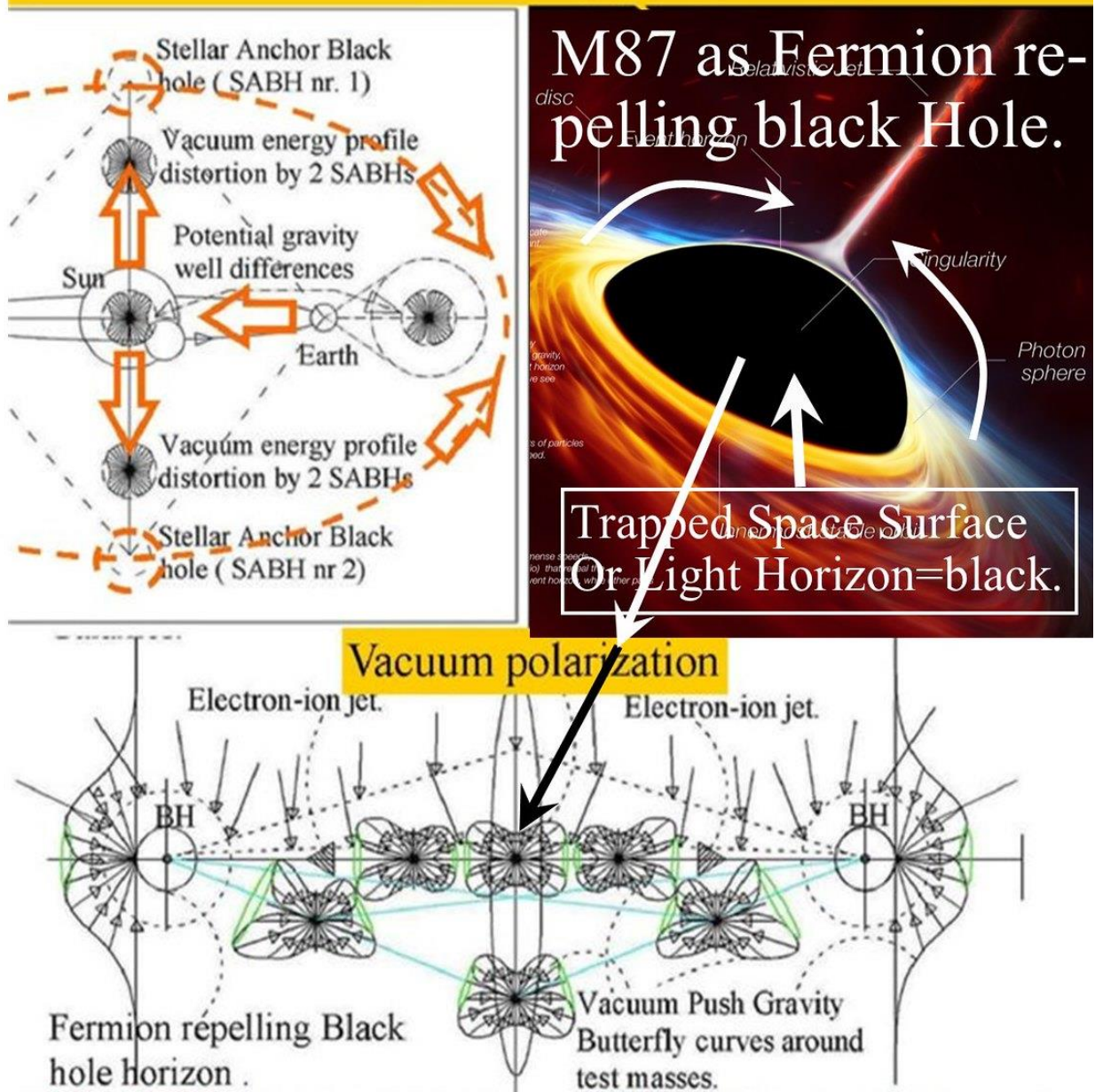
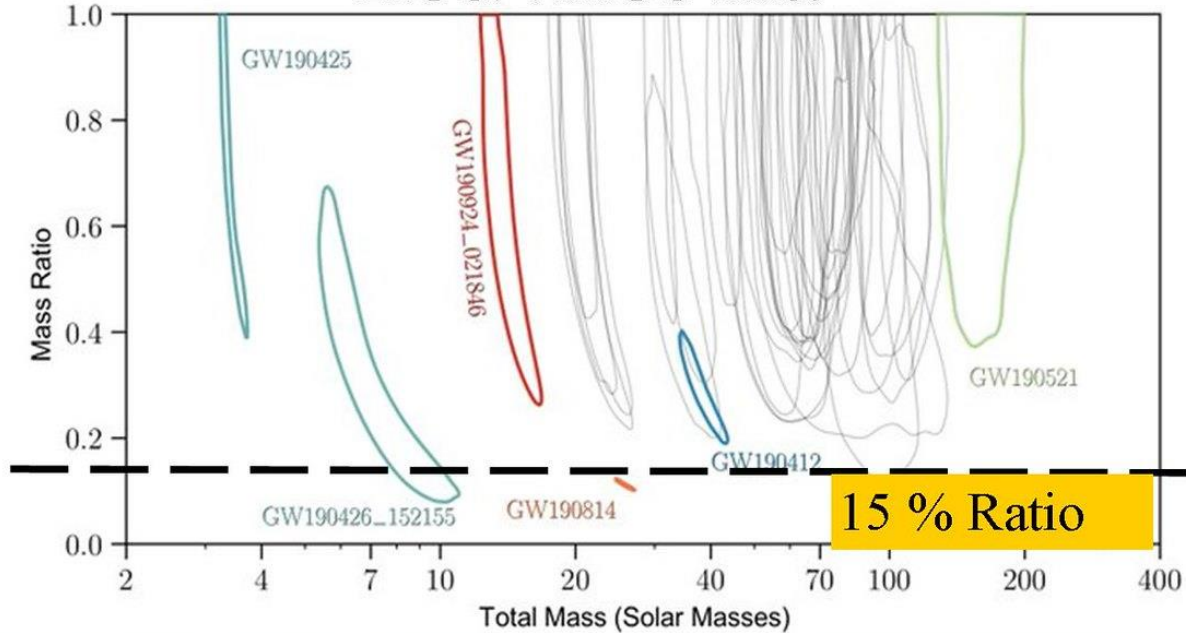

Figure 9,

# Equal sized Black Holes do NOT merge, but form HH systems for Star/Galaxy formation

## LIGO/VIRGO info.



## Splitting String Black Hole Inflation/Vacuum evaporation

The Origin of energy overdensities in the CMB  
 The Cosmic Background (CMB) energy overdensities can be explained by a Big Bang Black Hole splitting and evaporation process, according to Quantum FFF Theory.

EDM-BHs: Electric Dark Matter -Black Hole systems seem to be active at all scales.

Multi Bangs for Dual Symmetric Universes

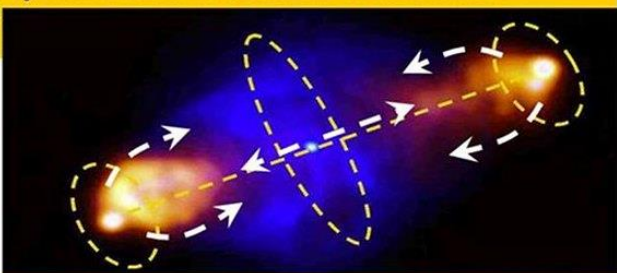
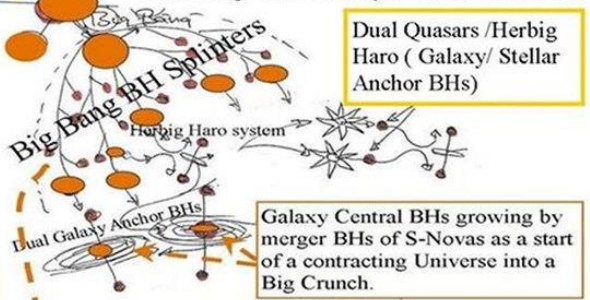

Cygnus A with dual plasma/gas producing "New physics" negative charged BHs as hotspots, with growing merger (SN) black hole in the center. Below: local Quantum vacuum push gravity vector butterflies originated by the BH vacuum absorption of dark vacuum energy.

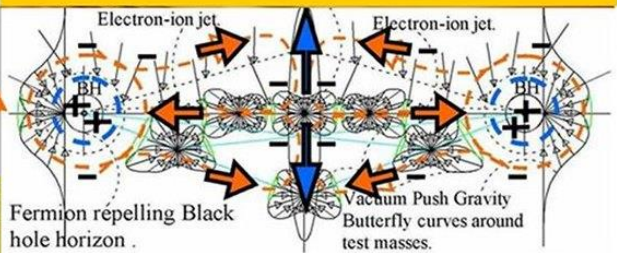
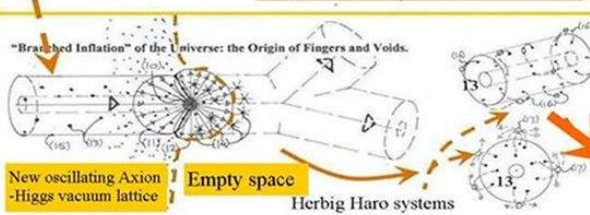

The origin of the Lyman Alpha Forest (15) and Higgs vacuum, by the splitting of the Big Bang Black Hole (BBBH) into smaller Splinter BHs (10). The splinter BHs (10) evaporate into smaller evaporating black holes at the Front (14) which compensate the pressure from the Backside splinter BHs (11). The BHs (11) are assumed to partly evaporate like BHs (14) also into a newly formed oscillating Higgs vacuum until the Higgs vacuum pressure stops the evaporation and leave Galaxy Forming BHs (13) behind. However single BH will pair (16) with the nearest other BHs to form Dumbbell systems, which efficiently form Giant Stars and Galaxies (17) in between. (author: Leo yuyk)

Figure 10,

## Stellar Herbig Haro Black Hole Splitting observation.

We observe here the splitting of a Black Hole into two equal parts, to form a dual so called Herbig Haro system with two Black Hole Bowshocks. (Q-FFF Model)

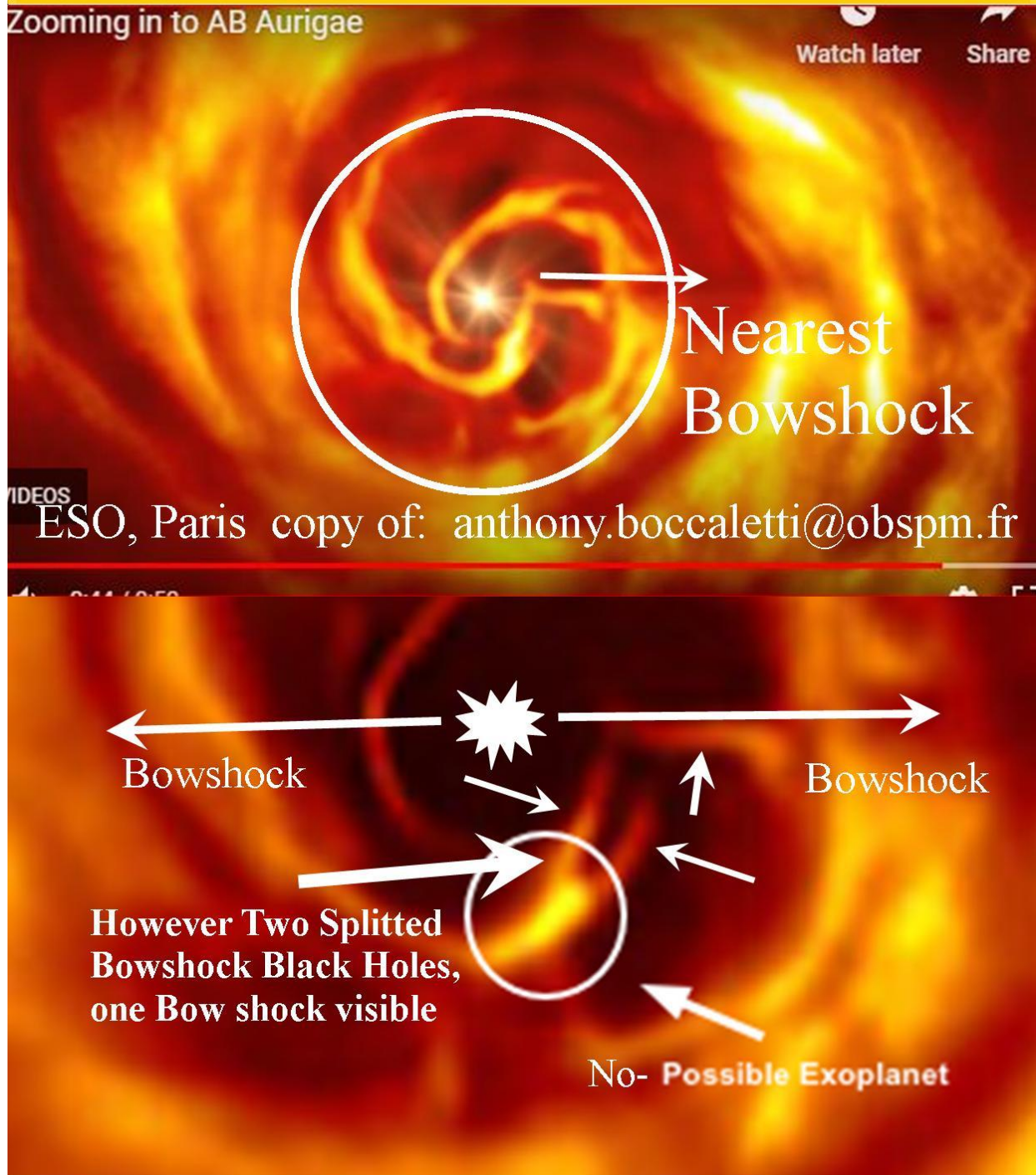

Figure 11,

Dual Xray and Gamma Ray Bubbles both sides of the Milky Way. Two GABHs ( Galaxy Anchor Black Holes) created by Herbig Haro BHs seem to be responsible, according to Q-FFF Theory.

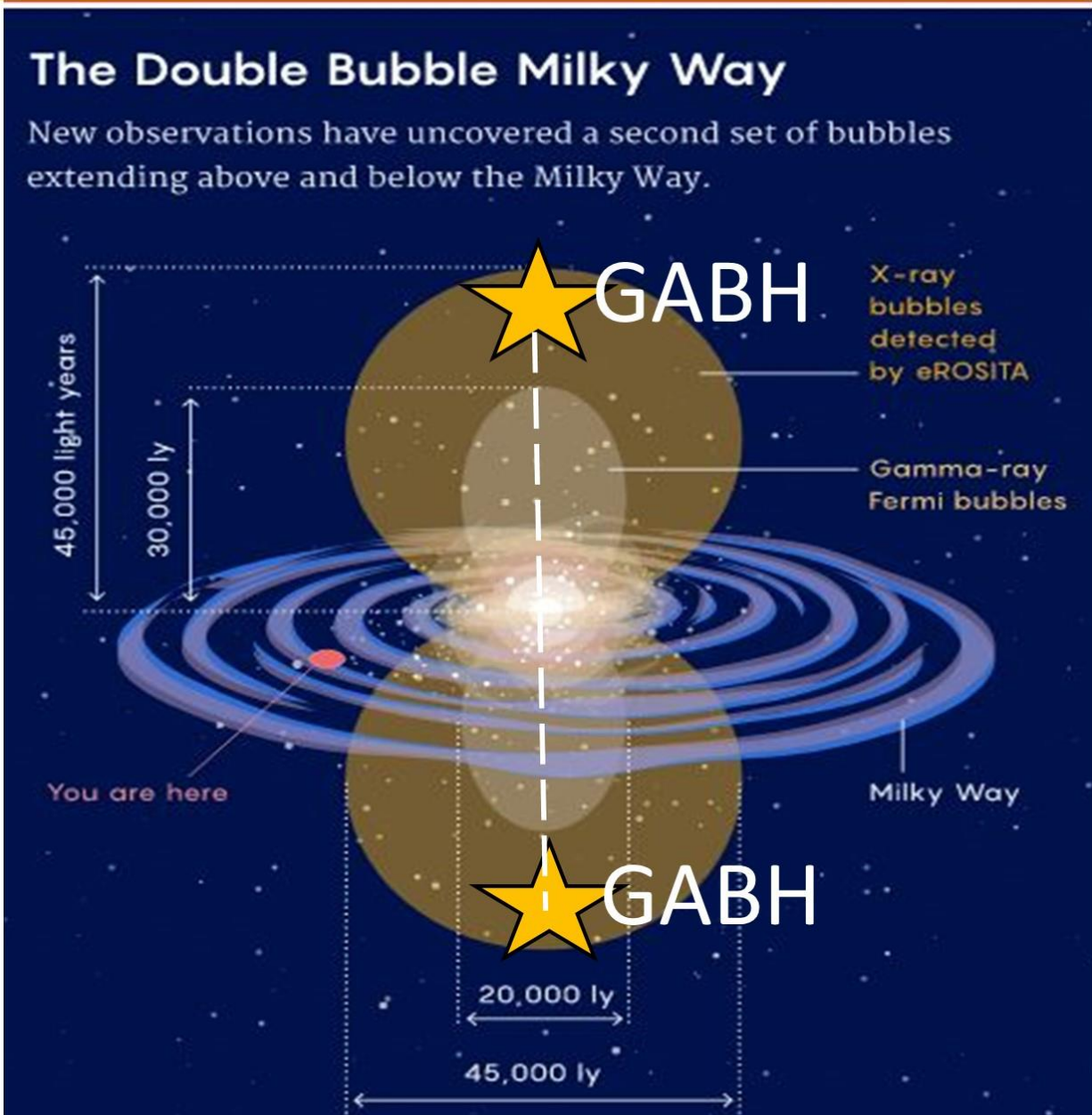

Figure 12,

# Double Bubble Disk Galaxies with Old Star Bulges

Two GABHs ( Galaxy Anchor Black Holes) created by Herbig Haro BHs seem to be responsible, for the bubbles. According to Q-FFF Theory.

Primary- Secondary Galaxy Anchor BlackHoles (GABHs), (Globular Dwarfs) Central BH and Stellar/Dwarf Anchor Black Holes, (SABHs), According to Quantum FFF Theory

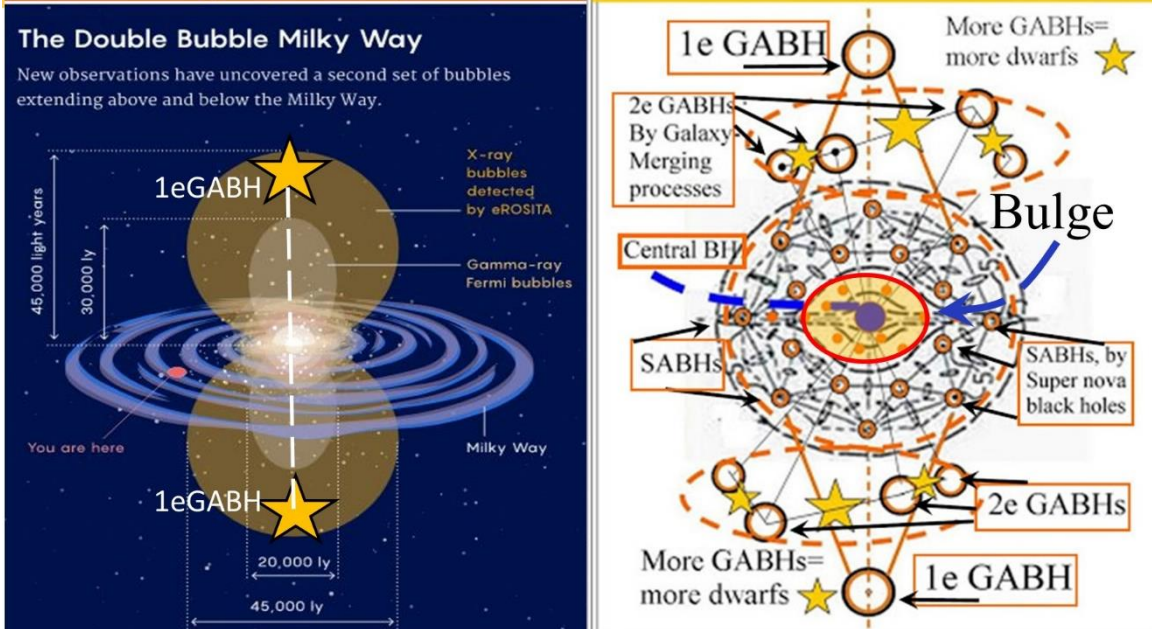

Figure 13,

# Blue Jets, Sprites and Elves above thunderclouds, with one or more rotating cells producing first blue jets by interference ( Q-FFF Theory)

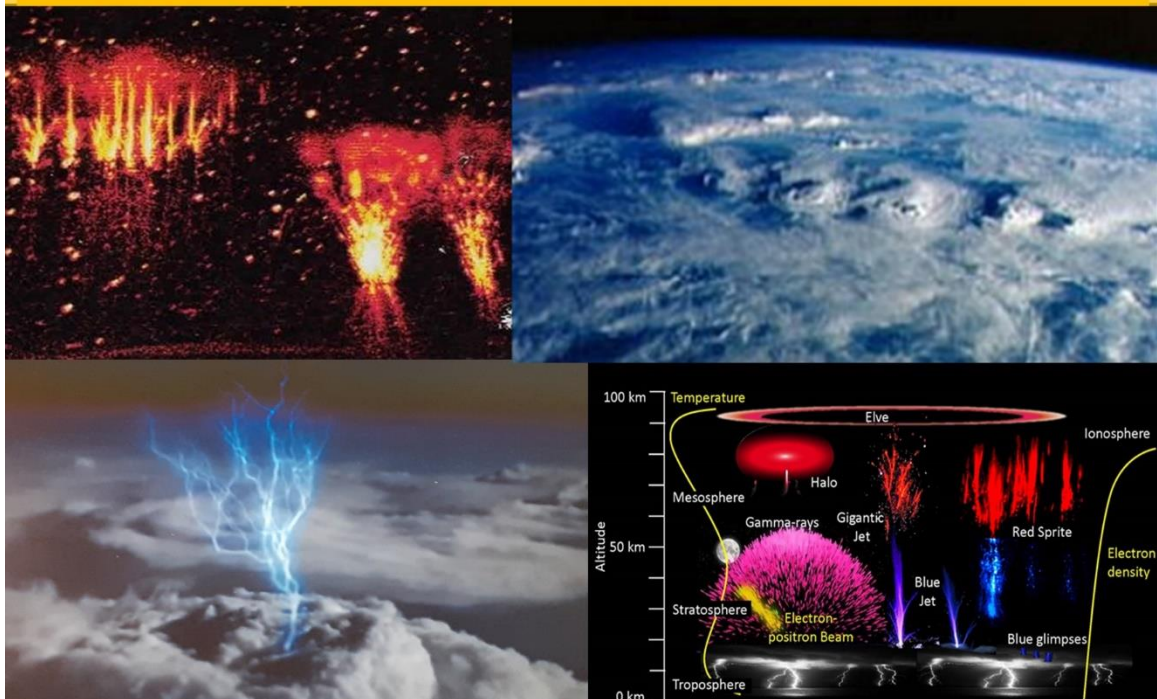

Figure 14,

# Fulgurite by Decaying Dark Matter Black Hole Lightning with hotspots at Beaches.

Lightning with fast evaporating splinter Dark Matter Ball Lightning.

Q-FFF Theory says: (Ball) Lightning is the same as String knots or Dark Matter or micro Black Holes. No Real Matter.



Figure 15,



# A New Penrose (Q-FFF) Black Hole.

The Penrose Trapped Space horizon, is creating the Universe, Plasma clouds pushing the black hole away from other masses. (Q-FFF Theory)

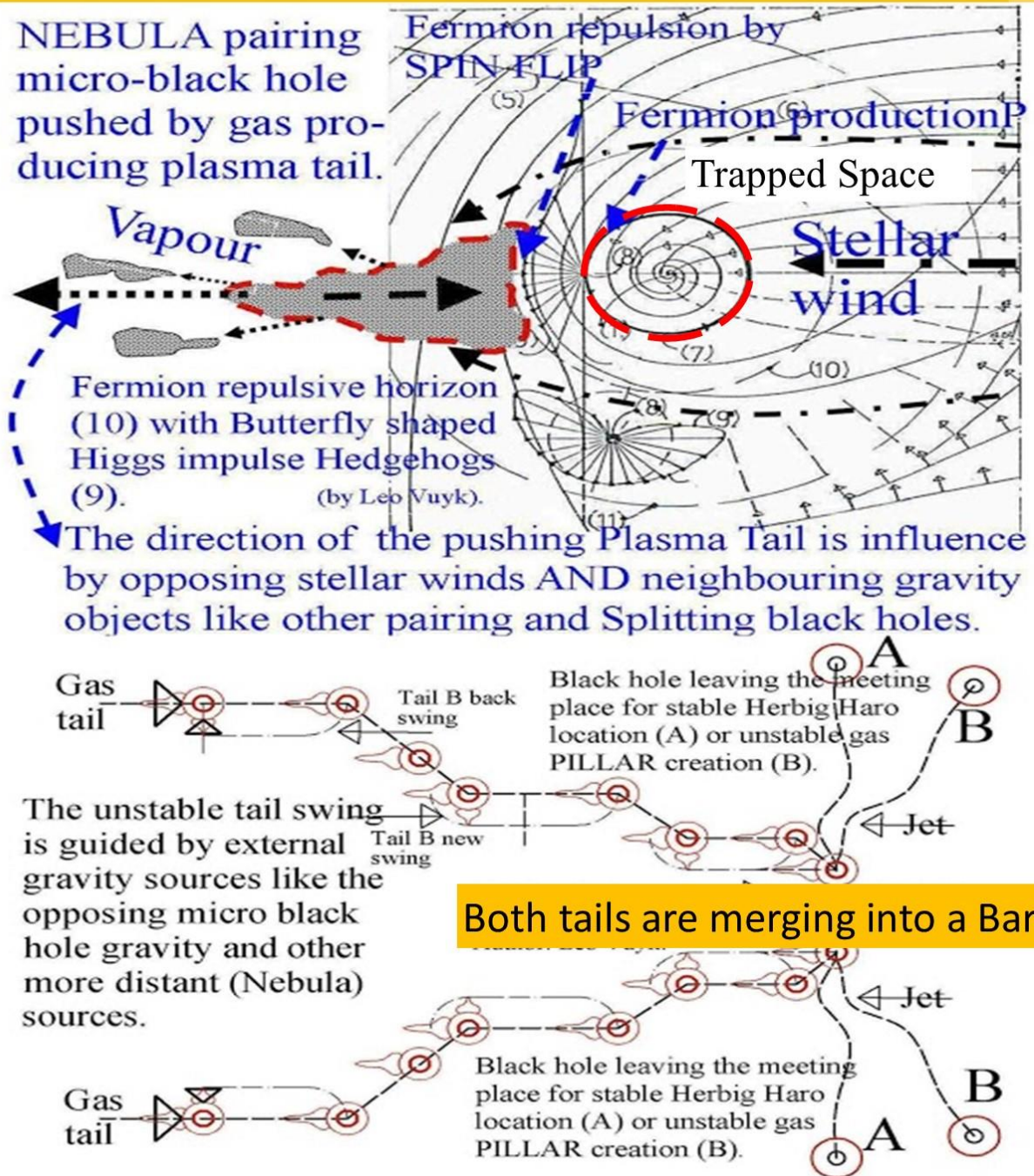

Figure 16,

# Rigid Transformer Strings of Q-FFF Theory.

Dark Matter Black Hole String knot.

3-D structure of 3x Leptons and mirroring 3x Anti Leptonic Rigid String propellers, according to Q-FFF Theory.



Transformation by collision of Rigid Vacuum Tori strings, (Axion-Higgs) by 90 degree rotation hinges.



Transformations into Photons Gluons and Neutrinos

Figure 17,

## The Wavefunction collapse in the (CP symmetric) raspberry multiverse by the entangled observation between (anti) copy particles

According to Quantum FFF Theory, the collapse of the wavefunction is assumed to be triggered by particle collisions with instant entanglement between (anti-) COPY universes. So there is Charge and Parity symmetry between the entangled particles living in opposing universes. Each particle is its own observer!! Each human has to deal with one or more opposing anti-COPY humans.

Mirror symmetry between CP symmetric universes

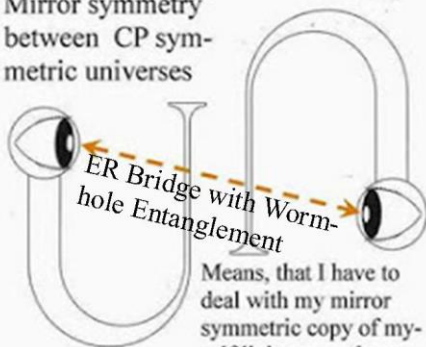

2-D Section through the raspberry multiverse, with huge void in the middle. The void in the middle is supposed to be originated by the start of the Fractal process, when the vacuum density of the former cyclic multiverse was still too high for a fine grained fractal process (see my book).

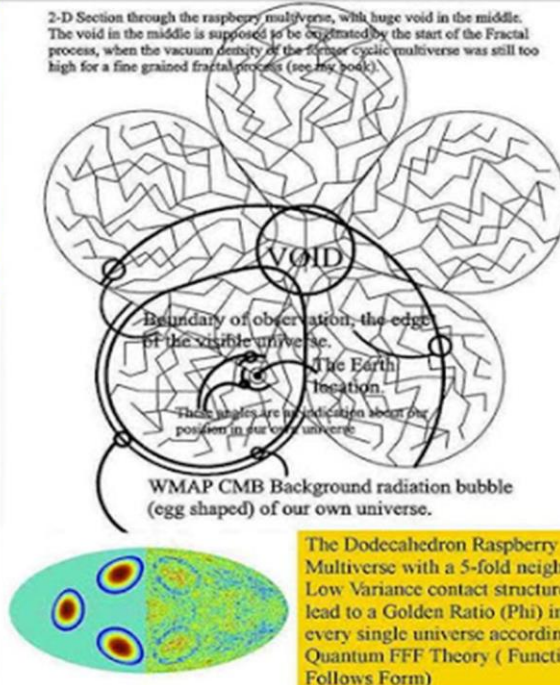

The Dodecahedron Raspberry Multiverse with a 5-fold neighbour Low Variance contact structure lead to a Golden Ratio (Phi) in every single universe according to Quantum FFF Theory ( Function Follows Form)

Figure 18,

# Alternative Standard Model of Quantum FFF Theory

With ONE Axion-Higgs Mother particle

The Axion- Higgs Vacuum Field particle is coded OOO, representing three closed Rigid String hinges of the mother rigid ring, able to rotate in steps over 90 degrees into L,U and R: Left Up and Right,

Explanation of the codes:  
 U= Up rotation (180 degrees)  
 O= Unchanged circle.  
 L= Left rotation (90 degrees)  
 R= Right rotation (90 degrees)

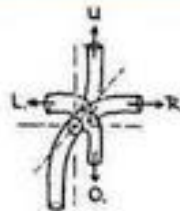

Summary with oscillation routes : ( ↔ ) or the definite Graviton decay route ( → )

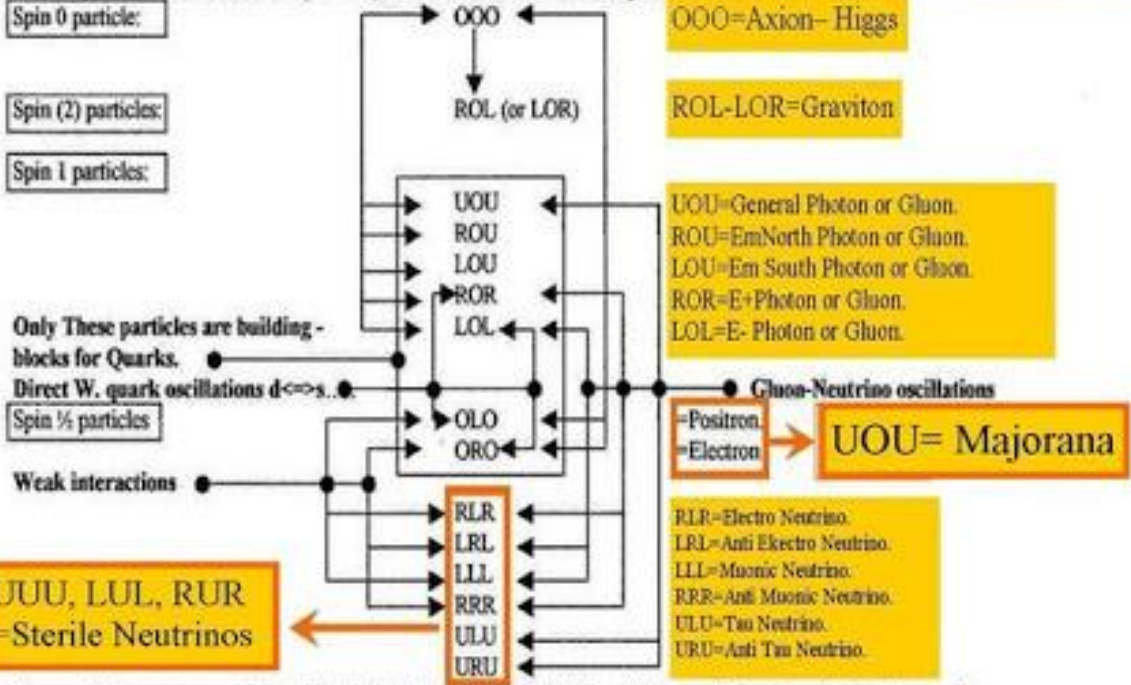

Higgs particles are supposed to oscillate in Tandem along so called linear Vacuum Lattices, two by two in opposite directions, as the symmetrical opposite pistons of a boxer engine, as the origin of all energy, spin and mass effects. This enables the Tandem Higgs particles to change the form of their own Torus into an Electron and Positron pair at

Figure 19, most rigid string particles with much dualities, ( still undiscovered) described by only three hinges and 4x possible rotations of 90 degrees. (ULRO)

# Galaxy Anchor Black Hole triple pairing.

The Mystery of NGC 1052 DF2 solved, by the triangle grouping (instead of dual grouping) of the Dark Matter Black Hole splinters of the Big Bang nucleus explosion, buried in the centers of the very large Globular clusters. According to Quantum FFF Theory. (triple Galaxy Anchor Black Holes: GABHs)

Below: an alternative triangulation of most global star clusters



Below: the usual BH dual pairing after the Big Bang splitting.

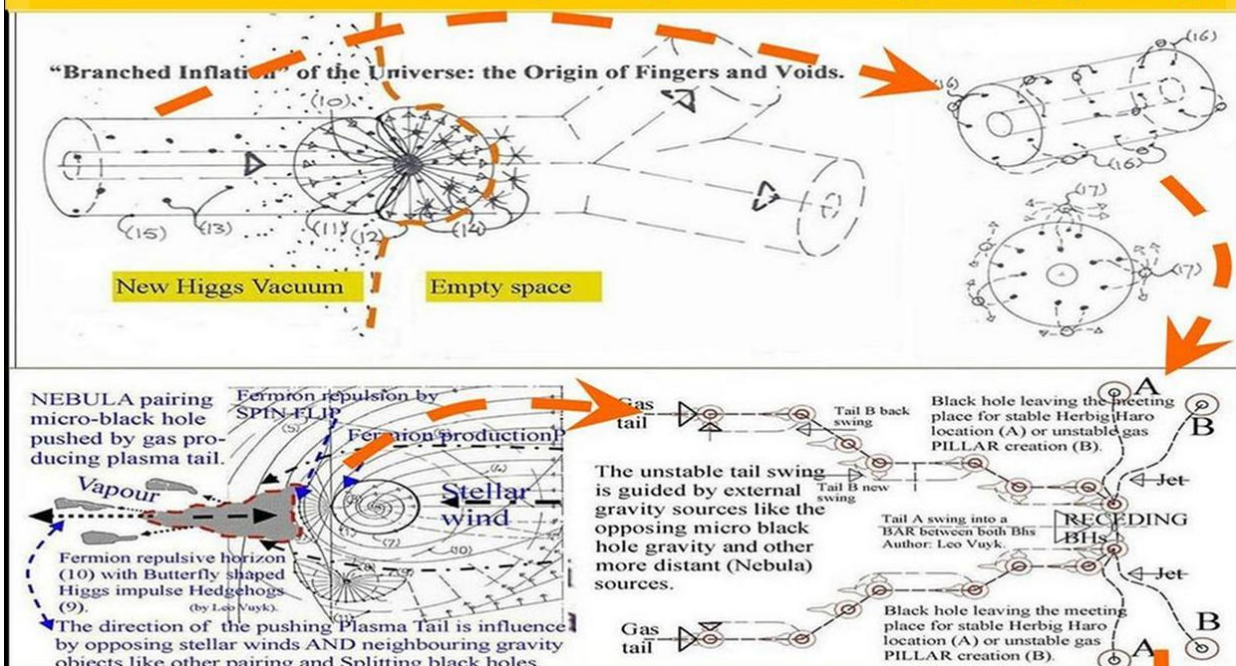
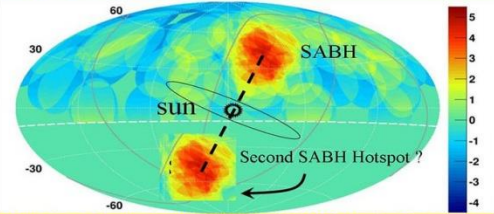

Figure 20, Galaxy Anchor Black Hole by triple Pairing of DMBHs, of NGC 1052 DF2

# Dual Solar Hotspots as remnants of former Herbig Haro system suggested in 2014, by Quantum FFF Theory and found later (2015) by K.Kawata et all. (UHECR)

A hotspot for powerful cosmic rays found under the Big Dipper, by the University of Utah. The mysterious source of cosmic rays is also reason to look at the southern hemisphere to observe the opposing second Stellar Anchor Black Hole (SABH) (Cosmic ray production by NEW black hole paradigm according to Quantum-FFF Theory).



According to Quantum FFF Theory, "New Black Holes produce Proton-Electron plasma. By the strong Casimir vacuum push gravity on the BH, the "Lighter" electrons will stay outside the "heavier" proton horizon (blue). As a consequence BHs have a strong electric potential, which is liberated by asymmetric processes in dual BH systems like Herbig Haro objects showing strong electro magnetic effects in open cluster star formation and Birkeland Alfven circuits around the earth and even in the so called BICEP 2 results.

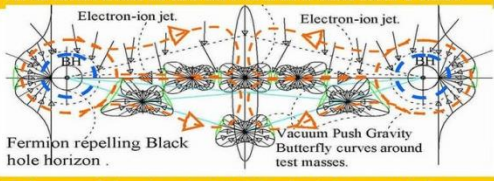

Scheme of the electric SABH principle around the sun.

## Thoughts on UHECR

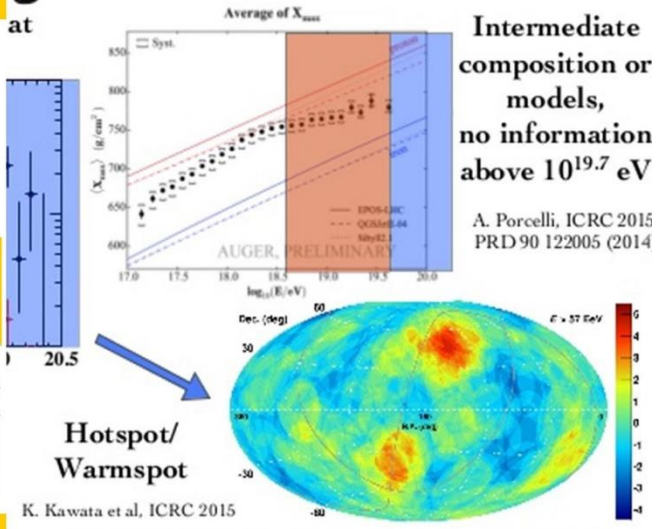
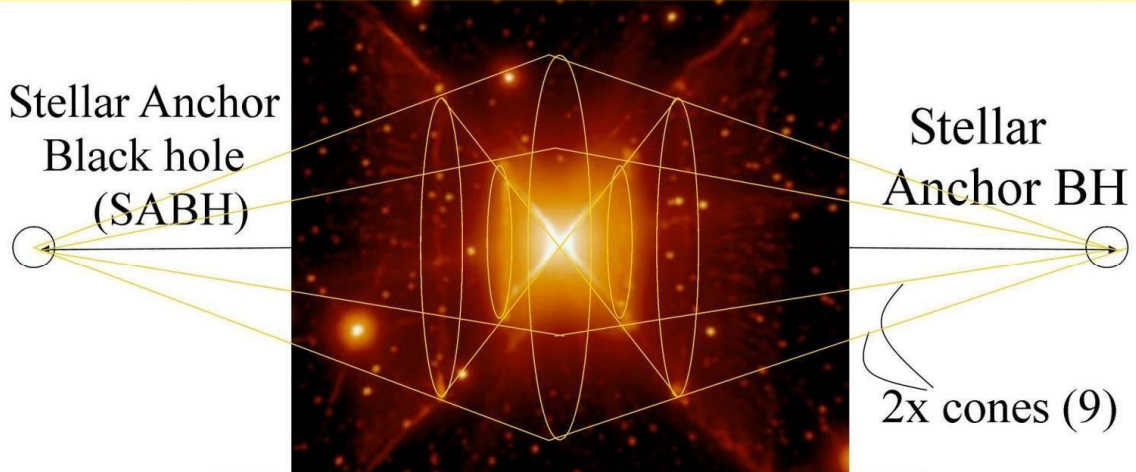

Figure 21, UHECR = Ultra High Energy Cosmic Radiation by A Porcelli ICRC 2015. PRD90122005 (2014) and A. Kawata et al. ICRC 2015.

# The origine of Double MWC922 interference rings



SABH interference rings with double coned starspot distribution.

Figure 22, The Red Square Planetary nebula MWC922, equipped with double cone structure of expelled material including trailing starspots (Micro Black Holes). There are FOUR cones of interferences originated by the two Stellar Anchor black holes (SABHs). These four cones seem to interfere with the TWO cones of expelled material of the star, leading to FOUR rings of interference.

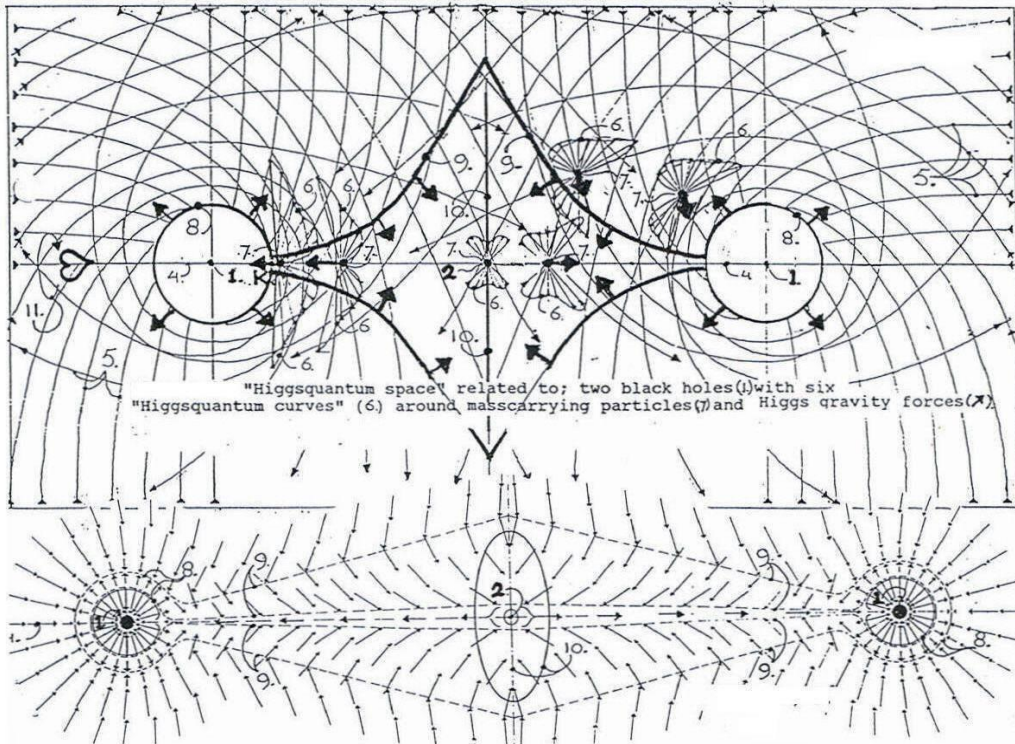

Figure 23, Axion Higgs Vacuum structure around a set of two Black holes, as is found to be present around Planetary nebula and early Galaxies and Herbig Haro objects.

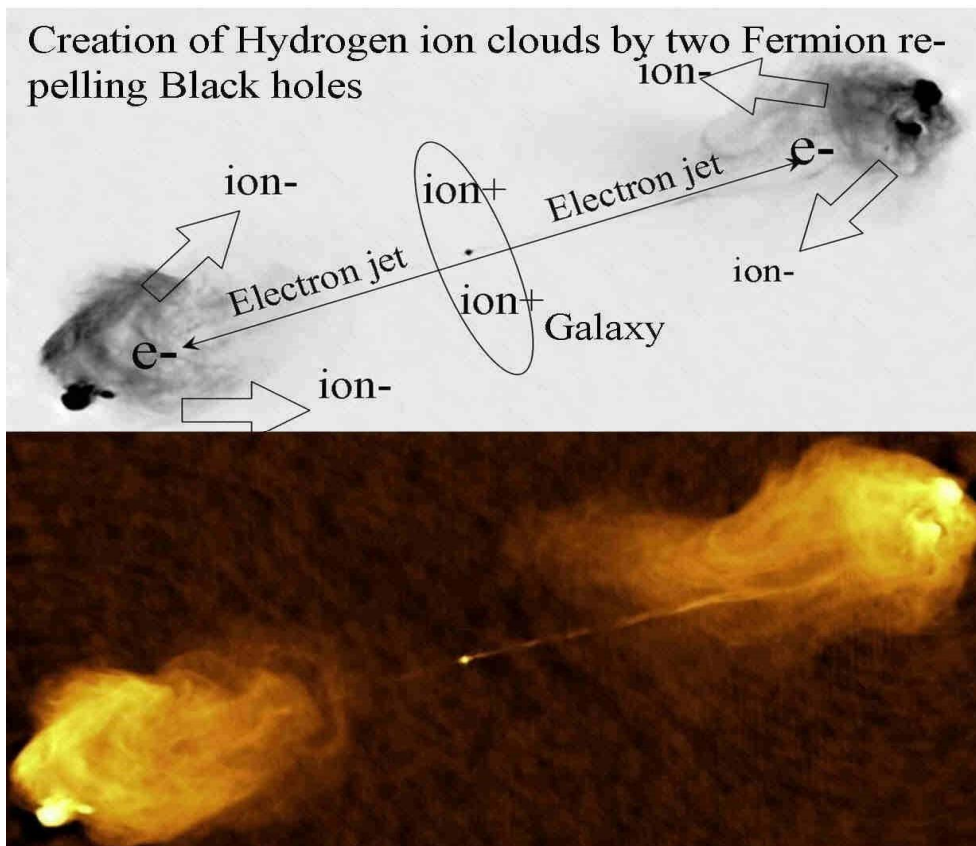

Figure 24, Cygnus A, equipped with Galaxy Anchor Black Holes (GABHs) clear electron jets and Hotspots, showing ionized gas production.

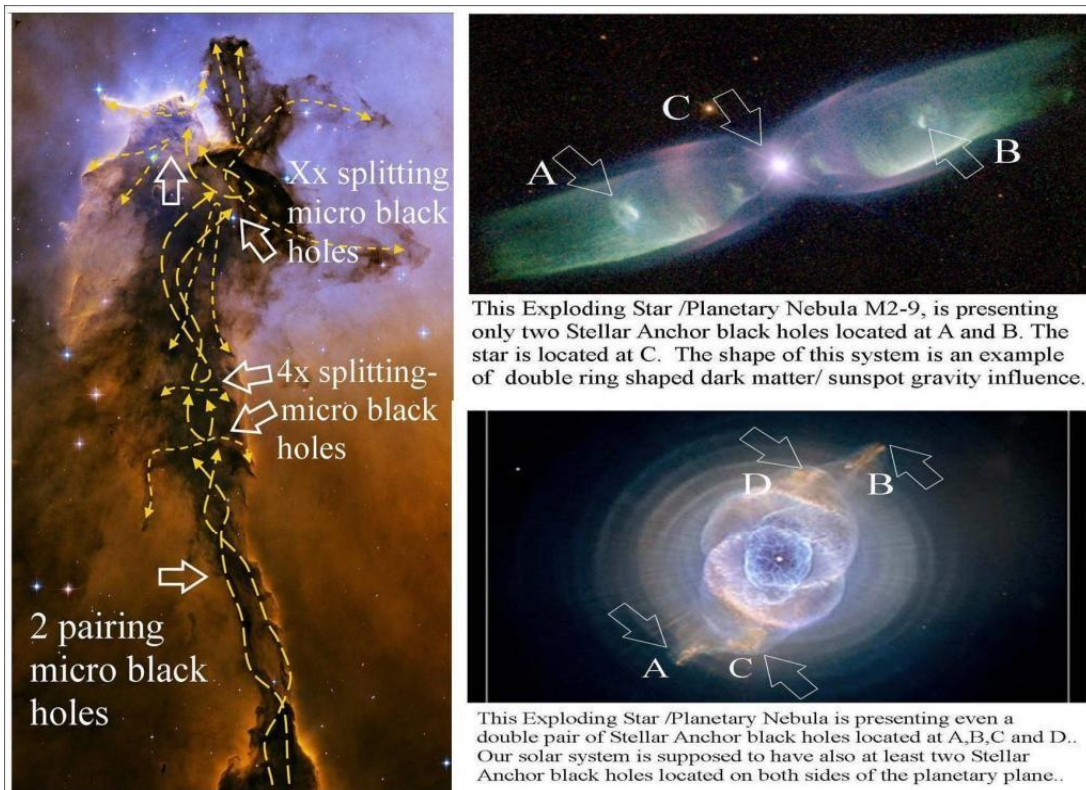

Figure 25, The Spire Eagle nebula, with two Planetary nebula, examples of the importance of black holes in the universe.

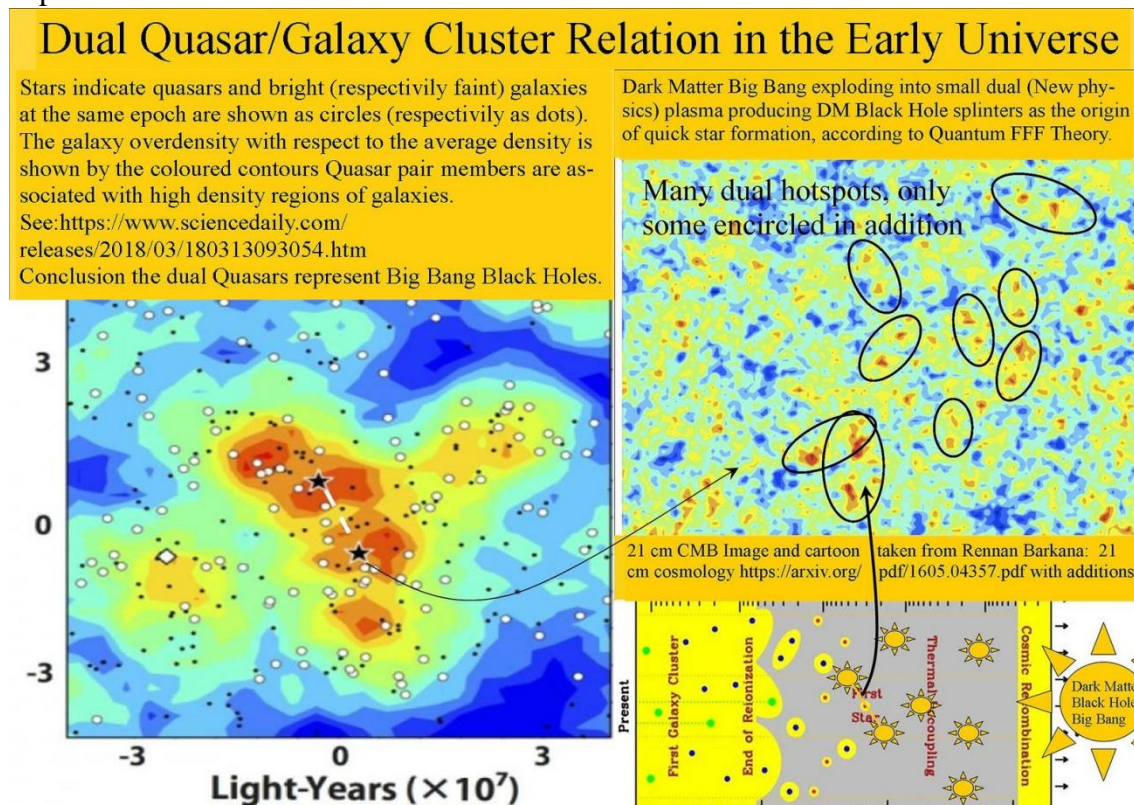
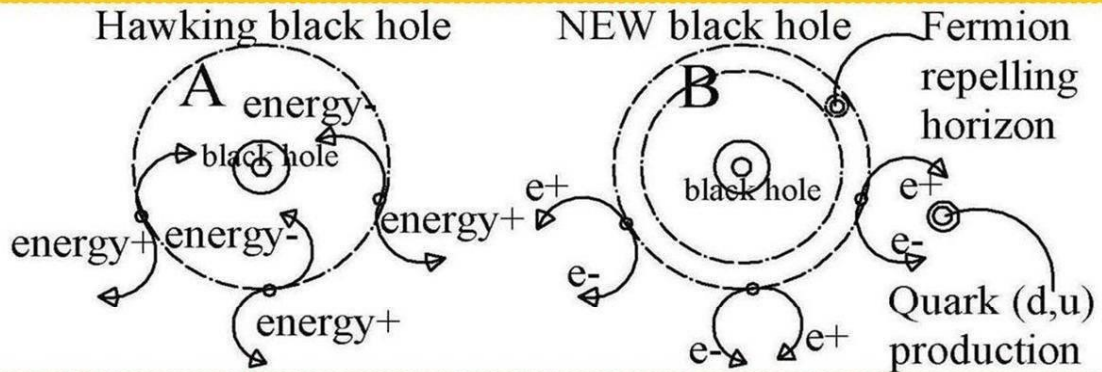

Figure 26, Dual Quasar/ Galaxy and Cluster forming relation in the early universe after Dark Matter Black Hole nuclear Big Bang splitting.

# Fermion/ Dust production and repulsion at small (Herbig Haro) black hole horizons during and after fractal inflation.



According to Quantum FFF Theory, there is no fermion information loss, only photonic information loss in a black hole. Quantum fluctuations around the BH horizon produce pairs of leptons.  $e^-$ ,  $e^+$  and even compound quarks (d,u, etc, see Fermion 3D string propeller theory: Fermion repelling by spin flip). For tripple BH horizons see image nrs 7, 10 and 11. Event horizon=7, Inner photon ring = 10, Outer photon ring = 11. Conclusion The Big Bang did not produce instantly all the Fermions in the universes. Even now lots of Fermions are produced by all BHs even the largest primordial Big bang splinters located outside large galaxies. see also: <<http://vixra.org/abs/1410.0039>

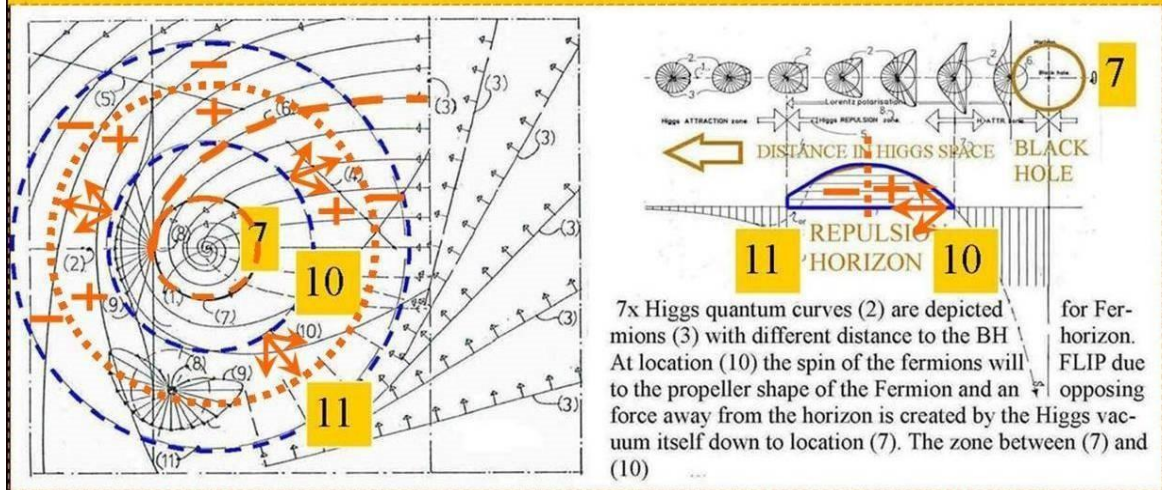

Figure 27, Principle of Fermion repulsion around a black hole according to Quantum FFF theory..



## First evidence for a Solar Anchor Black hole: a Cosmic Ray Hotspot

A mysterious source of high energy cosmic rays are found north near the Big Dipper (university of Utah) In addition: the south pole IceCube experiment found concentrated neutrino sources at north and south locations (see upper figure, nrs.23+ 18) Both could represent the Stellar Anchor Black Hole (SABH) locations of the sun, according to Q-FFF theory.

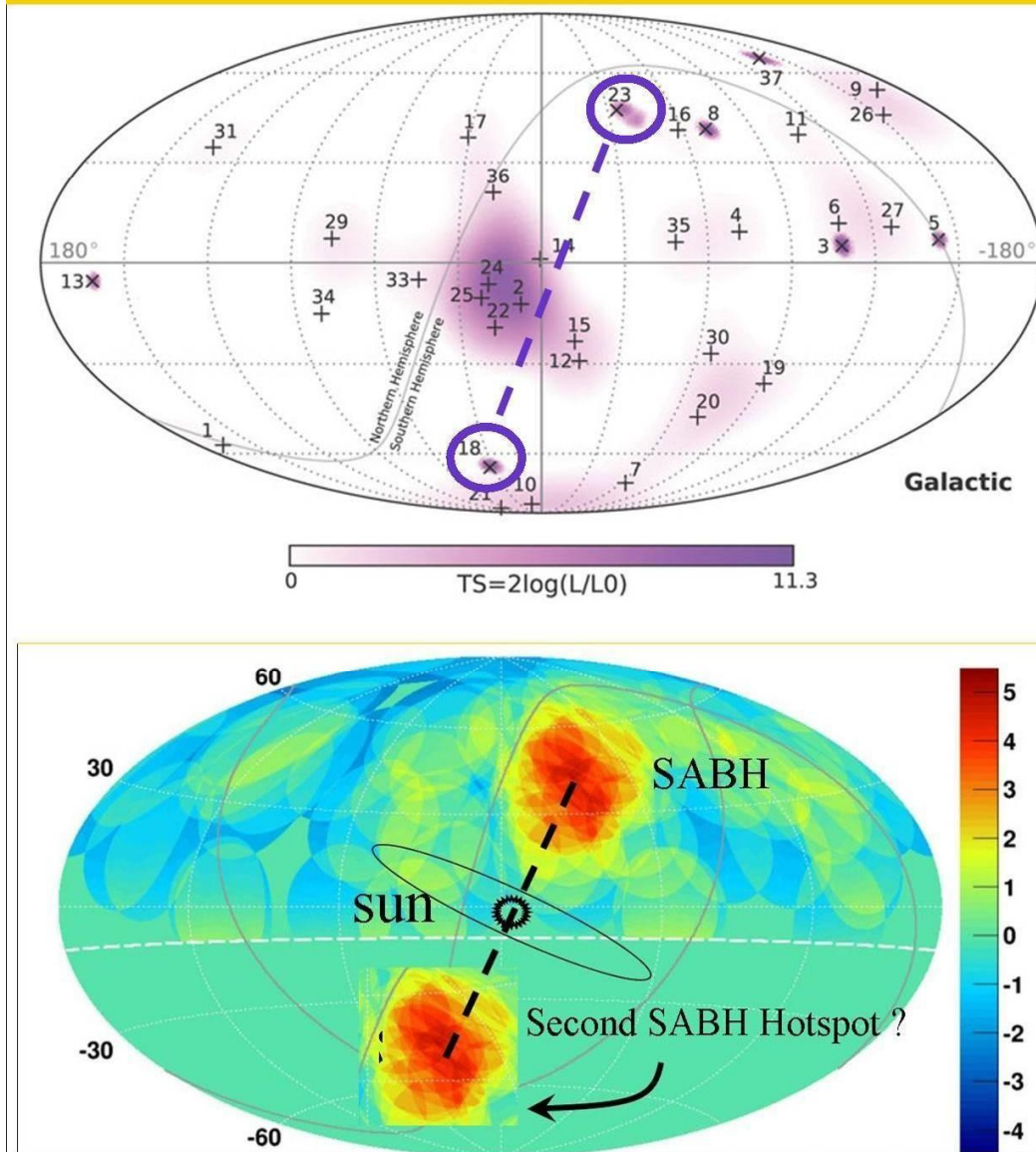

Figure: 28, 9-july 2014. first evidence for the first Solar Anchor Black Hole. (SABH) A hotspot with powerful cosmic rays found under the Big Dipper, by the University of Utah. Now ( 2017) however the southern counterpart ( the second SABH hotspot) is found, See also: <http://www.sciencedaily.com/releases/2014/07/140708092910.htm>

Mystery of the “super string of young stars” around two merging giant ellipticals in the cluster [SDSS J1531+3414](#) solved by the merging and stabilisation into multiple new star forming Herbig Haro systems of both Galaxy Anchor Black Holes (GABHs) systems of both galaxies. (according to Quantum FFF theory)

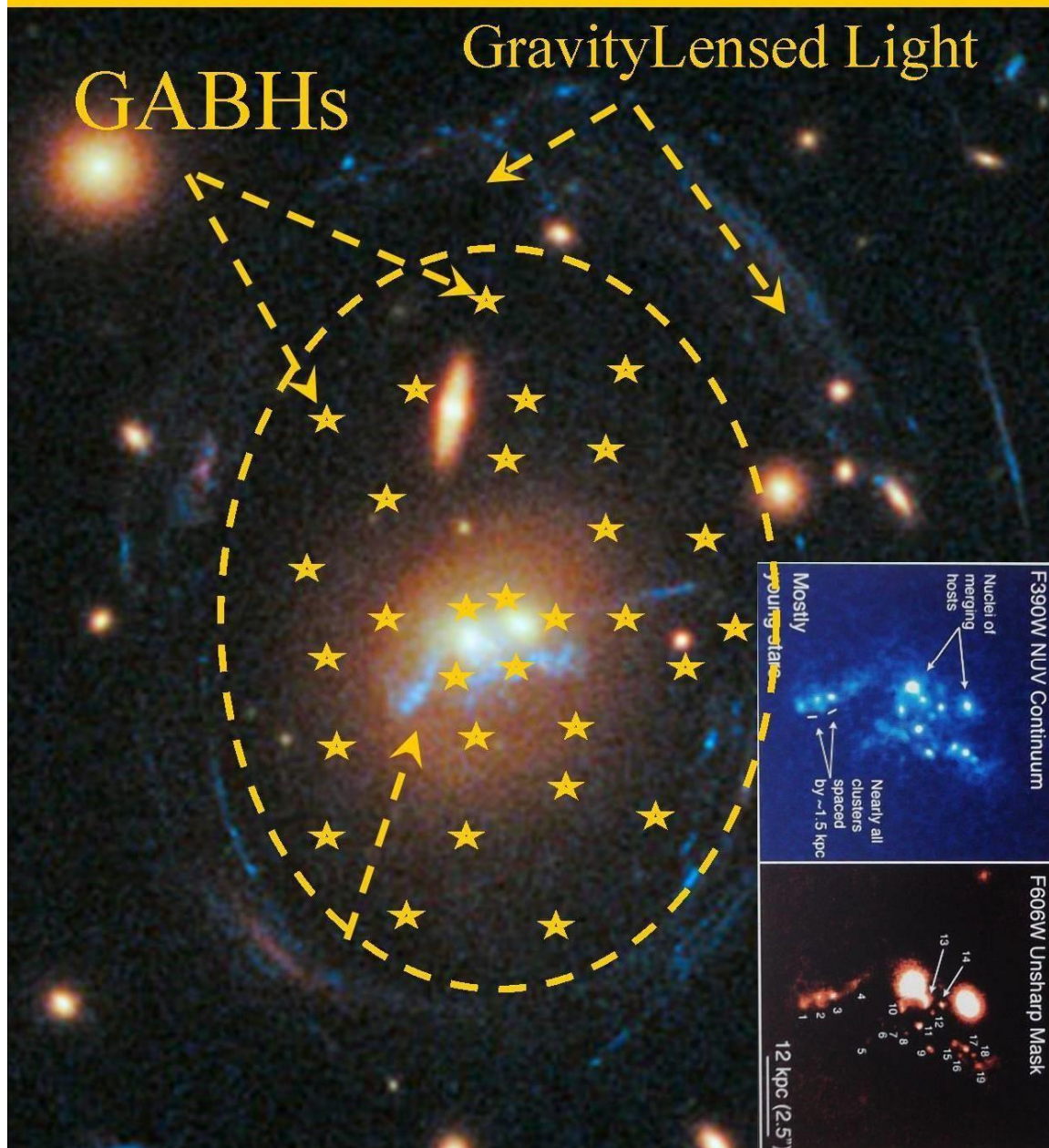

Figure: 29, Gravity lensed light through central hole in the globular Shell of Dark matter Black Holes or Galaxy Anchor Black Holes ( GABHs). The absence of GABHs in the centre is supposed to do the job.

**Some dual dark matter black hole related structures and HH systems.**



Abundance of X-shaped radio sources with off-axis distortions. With  $Z=0.2-0.8$ . by D.H.Roberts et al. in line with the Quantum FFF model.

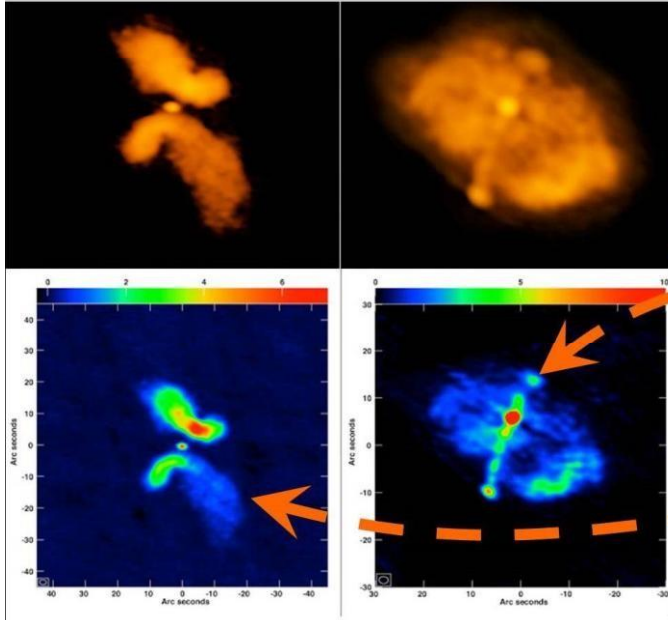
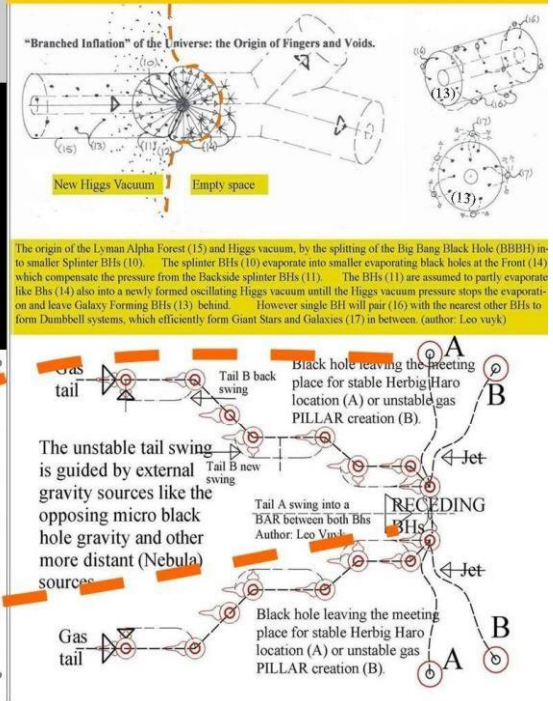

Figure 32, Abundance of X shaped radio sources.

How massive galaxy clusters are formed in the early Universe. According to Quantum FFF theory, the Big Bang process is the result of a fractal shaped splitting and evaporating BB dark matter black hole process creating the Lyman Alpha structure of galaxy distribution. By the evaporation of BB "splinters" (14) the oscillating Higgs field vacuum is created by the so called "Branched inflation". Retarded Black hole splinters (13) do not evaporate by Higgs vacuum pressure, but create plasma "tails" pushing them away from the center of gravity in search for a partner to form a Herbig Haro system.(16,17)



## Secondary and tertiary Dual BH Herbig Haro systems, as the origin of different shaped dwarf galaxies and Star clusters.

Below: Simplification of different sized dual black hole (5) based Herbig Haro Systems with dwarf and star formation in between, in the halo of the MW.

Dual Galaxy- and Stellar Anchor Black Holes (G-SABHs) as former Herbig Haro bowshocks, observed in deep space or Planetary Nebula.

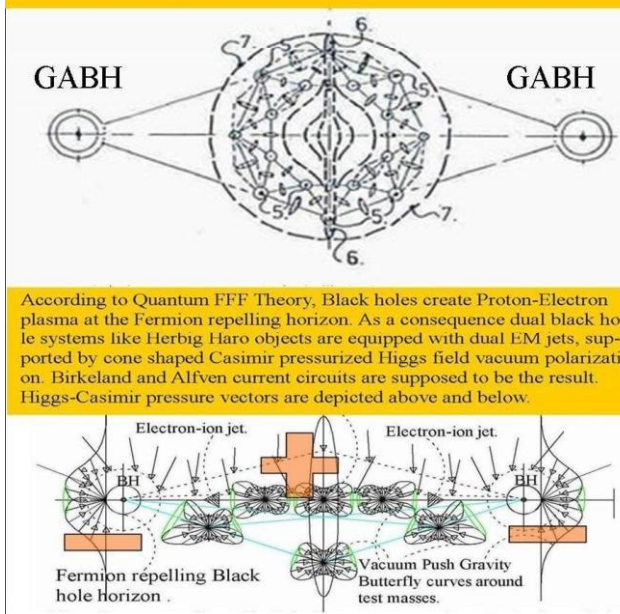

According to Quantum FFF Theory, Black holes create Proton-Electron plasma at the Fermion repelling horizon. As a consequence dual black hole systems like Herbig Haro objects are equipped with dual EM jets, supported by cone shaped Casimir pressurized Higgs field vacuum polarization. Birkeland and Alfvén current circuits are supposed to be the result. Higgs-Casimir pressure vectors are depicted above and below.

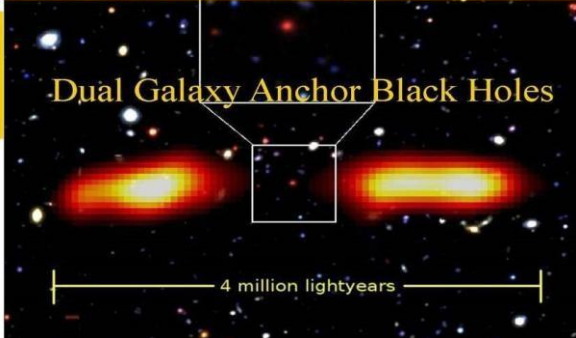
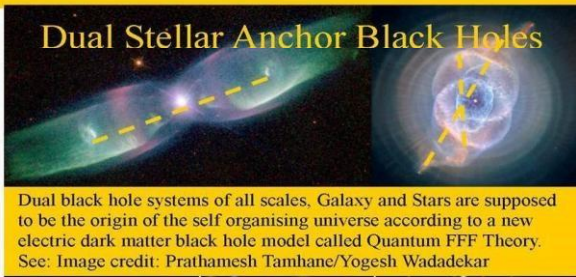
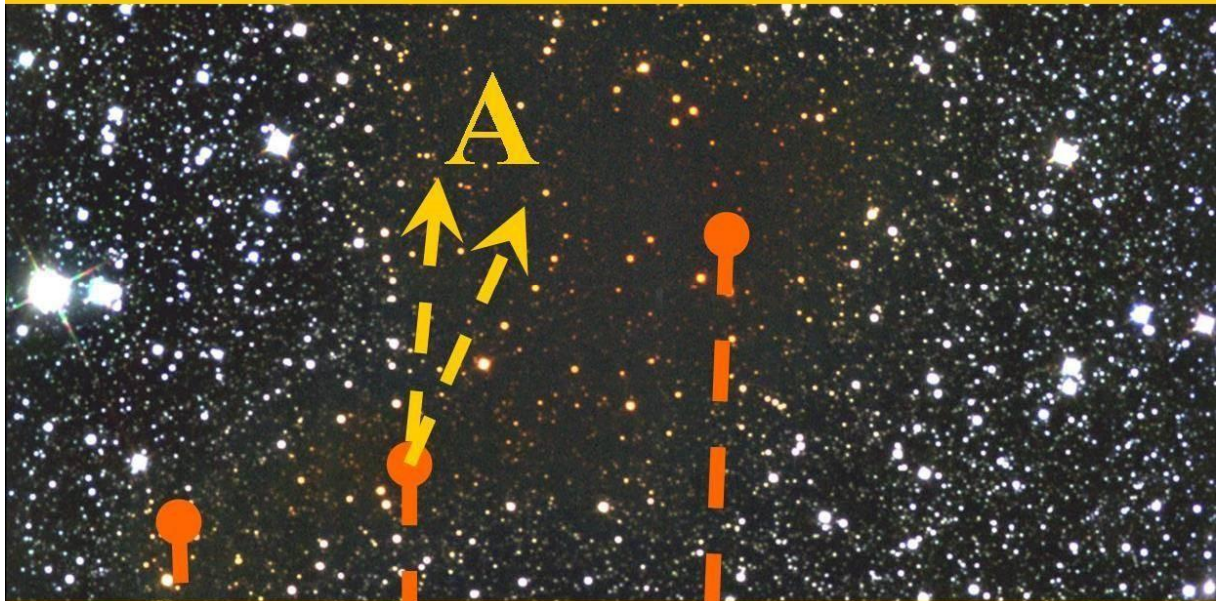

Figure 33, Secondary and Tertiary Dual BH HH systems.

Bok Nebula ESO 9934 with indication for a Micro-Herbig Haro dual BH system inside. According to Quantum FFF Theory.



Two aligned stellar alike strings (A) starting from the central white hole (B) located between the Herbig haro Black Holes (C)

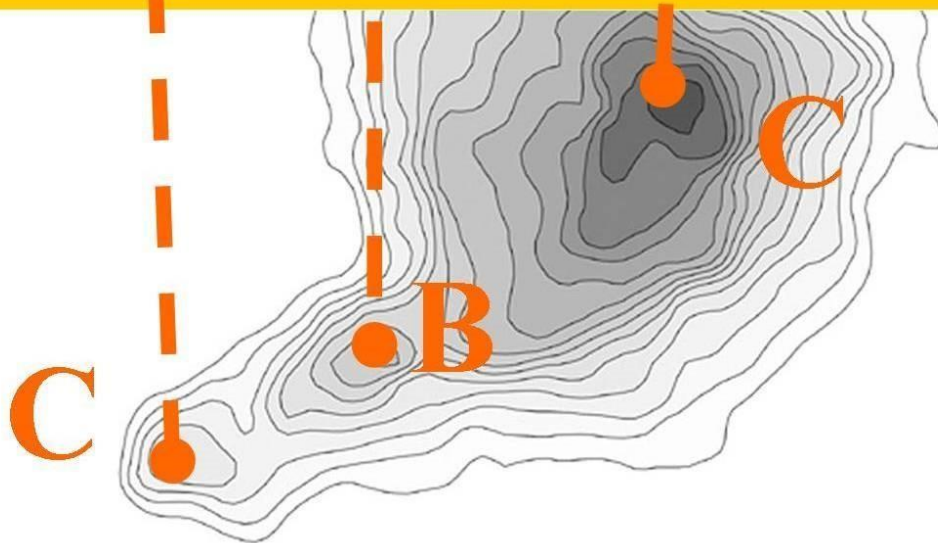
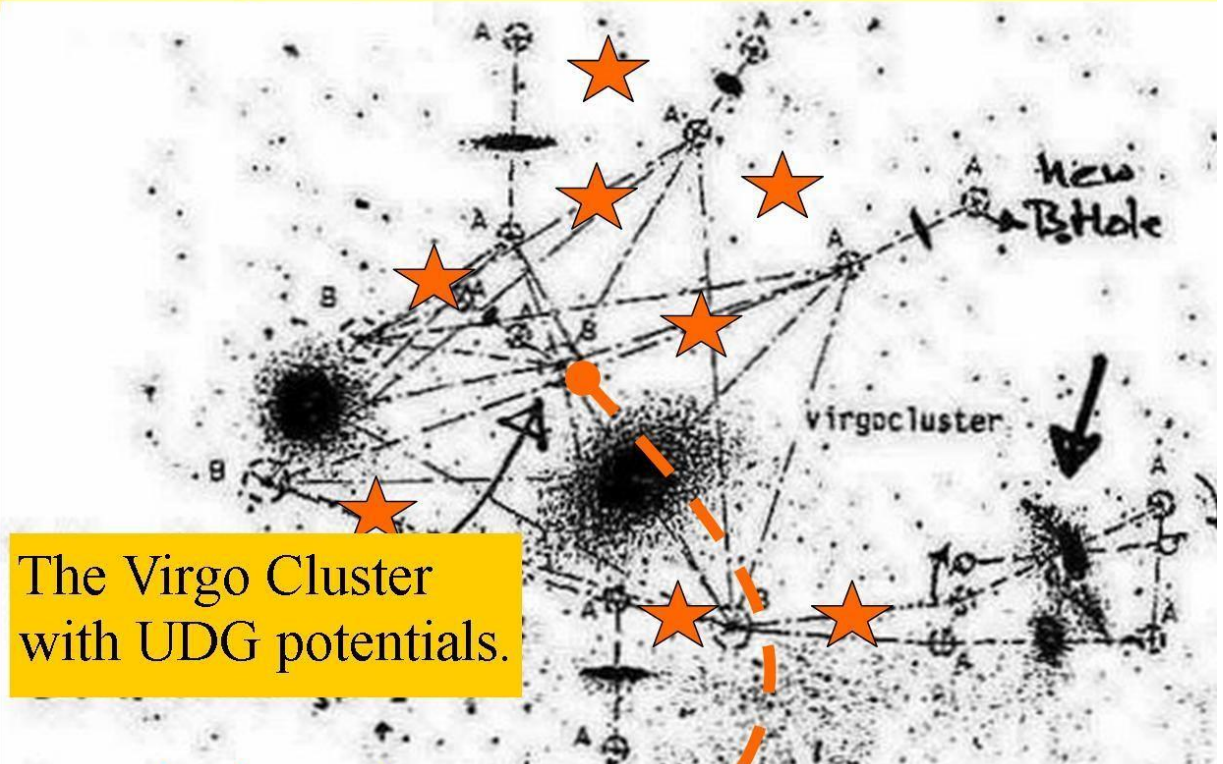

Figure 34, BOK Nebula ESO 9934.



Ultra Diffuse Galaxies (UDGs) formed inside Clusters between GABHs ( External Galaxy Anchor Black Holes= Dark Matter point sources). According to Quantum FFF Theory.



The Virgo Cluster with UDG potentials.

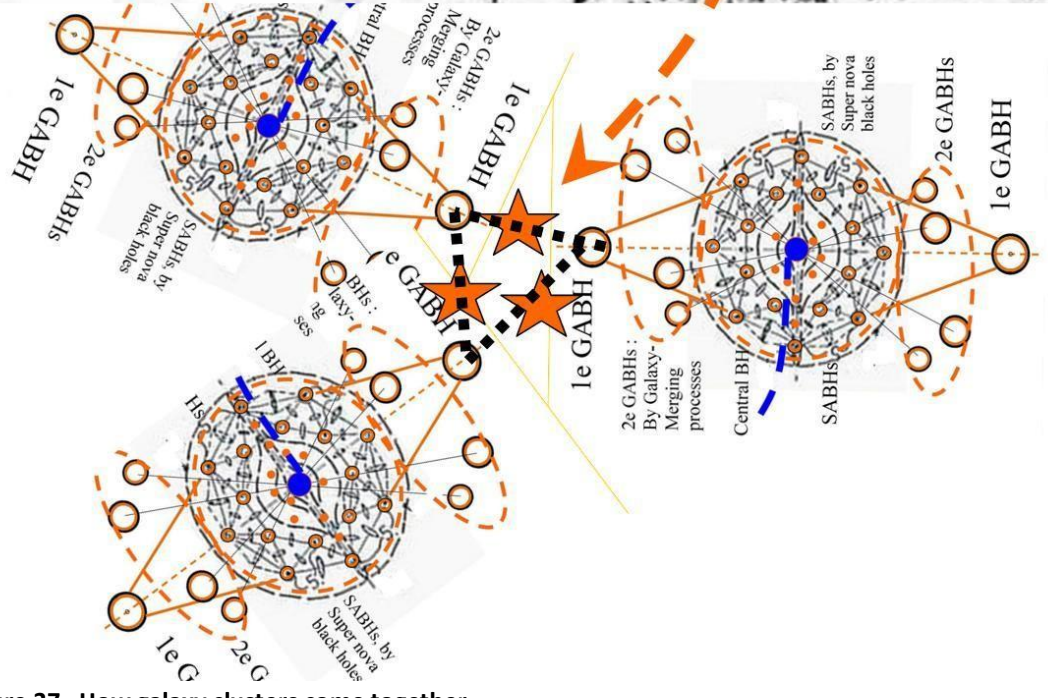
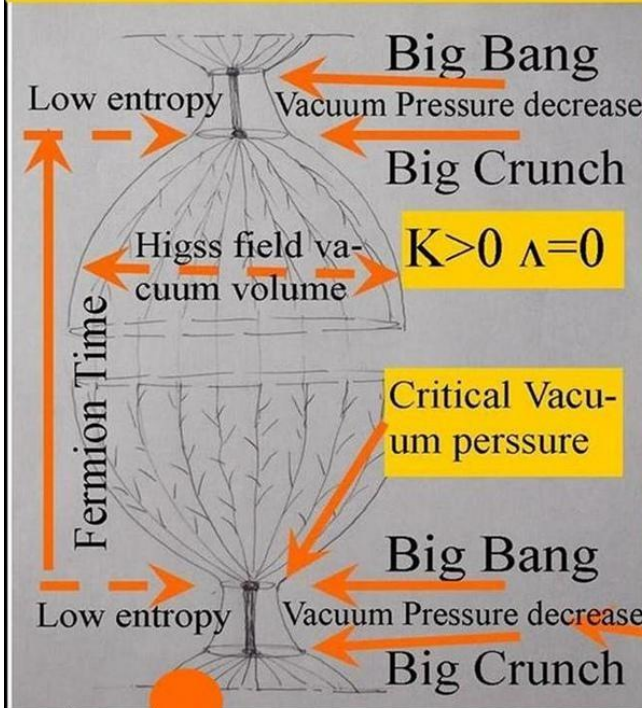

Figure 37. How galaxy clusters come together.

# Bouncing/ Cyclic Multiverse.

The Big Bang and Big Crunch originated by Black Hole splitting, pairing and recycling into massive growing central galaxy black holes, according to Quantum FFF Theory.



Below: The pairing and splitting primordial black holes as creators of spiral galaxies, able to merge and form elliptical galaxies, (like M87) equipped with a central growing black hole.

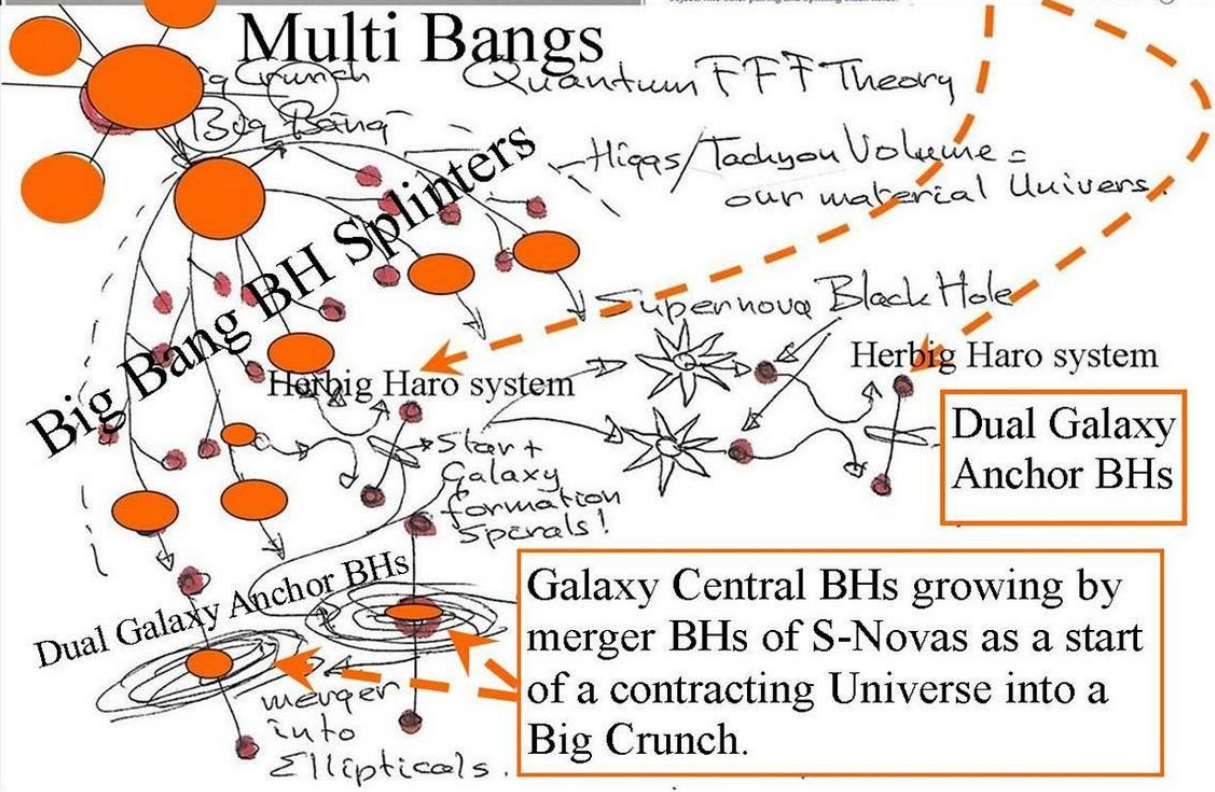
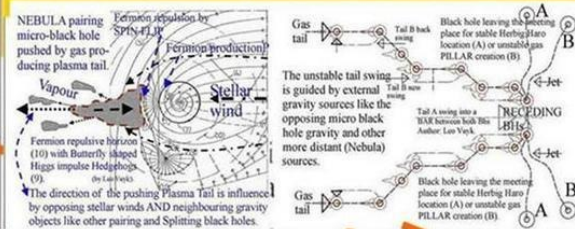
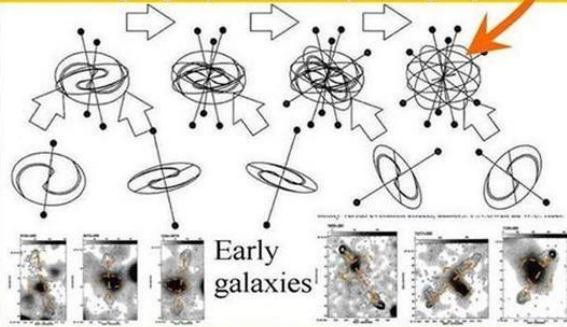

Figure 38, The big Bang splitting of the Dark Matter Black Hole nucleus.



**We seem to live in a rigid string based information universe.**

**See image:**

**Interference Quantum Black Holes (left) could travel through the LHC machine at CERN without notice and produce UFO dust particles by decay heat.**

**IF Quantum black holes have no propeller spin or EM charge, then we could live in a rigid string based information universe.**

<http://vixra.org/pdf/1707.0189v2.pdf> and:

<http://vixra.org/pdf/1306.0218v1.pdf>



**Figure 39, Rigid string topology with sub quantum structure able to make quantum knots of different masses and functions.**

## Three or more Higgs models in a 3D Rigid String System.

In 1012 the Atlas particle smasher in LHC found two distinct possible Higgs masses around 125GeV.: 123.5 and 126 GeV. Later a bump was found around 375 GeV. Here I present 3D suggestions for such bumps in a Rigid String based Quantum FFF model.

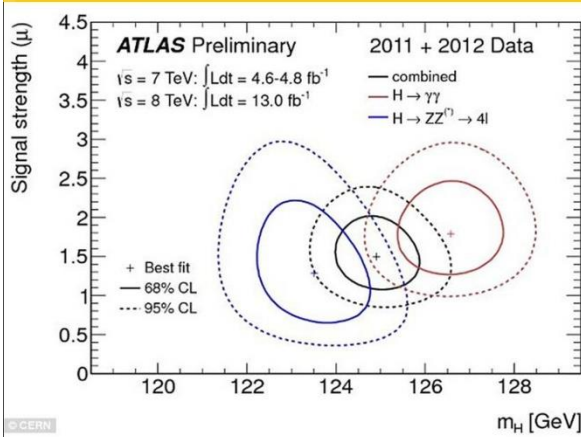

The New Standard Model of Quantum FFF Theory, with Transformer Toroid Axion Higgs, ( $AxHi$ ) as the zero mass Virgin String particle.

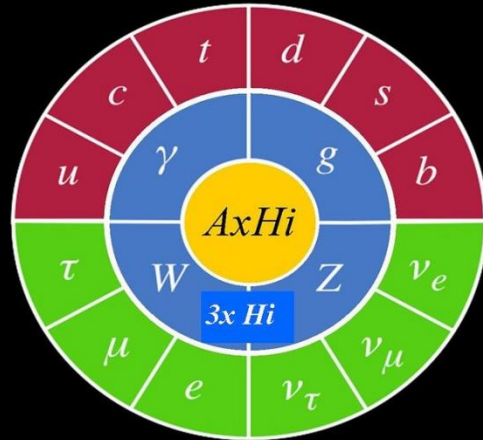

Three different shaped Composite Higgs Particles seem to be possible at least: 123.5/ 126 (Mirror Symmetric), and 375 GeV.



Figure 40, Three or more Higgs models in a 3D Rigid String system.

## Non Inertial Gravitating Dark Matter Black holes.

According to Quantum FFF Theory, stable Black Holes are growing by "eating" the gravitating ( Casimir) pressure vacuum without the standard gravity related inertial effects, the result is that 1: Small BHs seem to concentrate around the central giant Galaxy BH . 2: Galaxy cluster mergers like Abell 520 overshoot and leaving behind their own Dark Matter content.

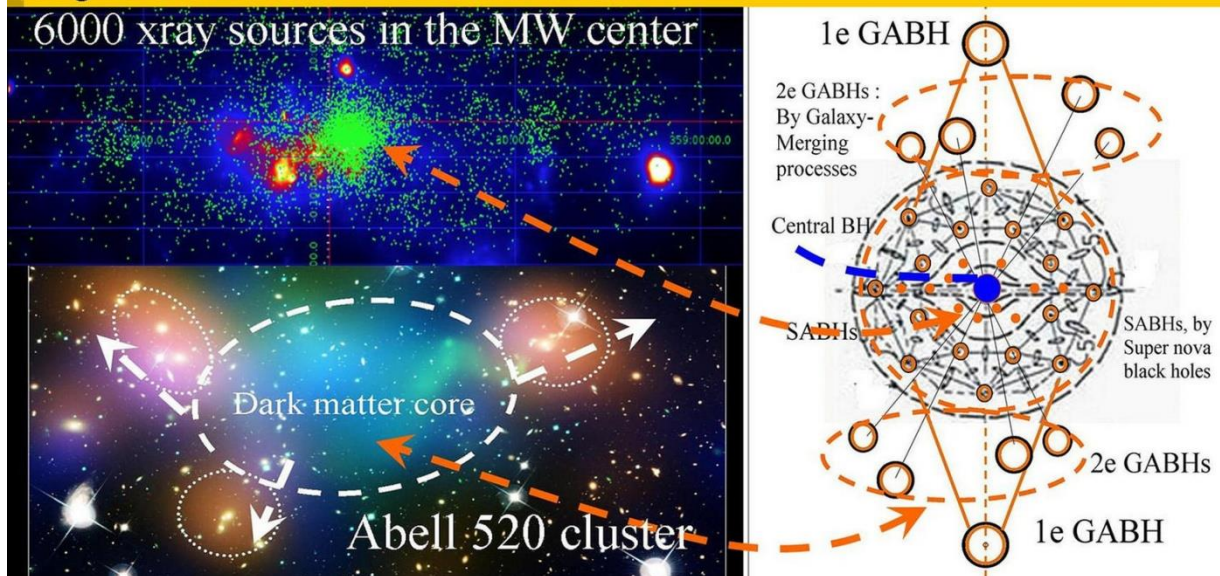
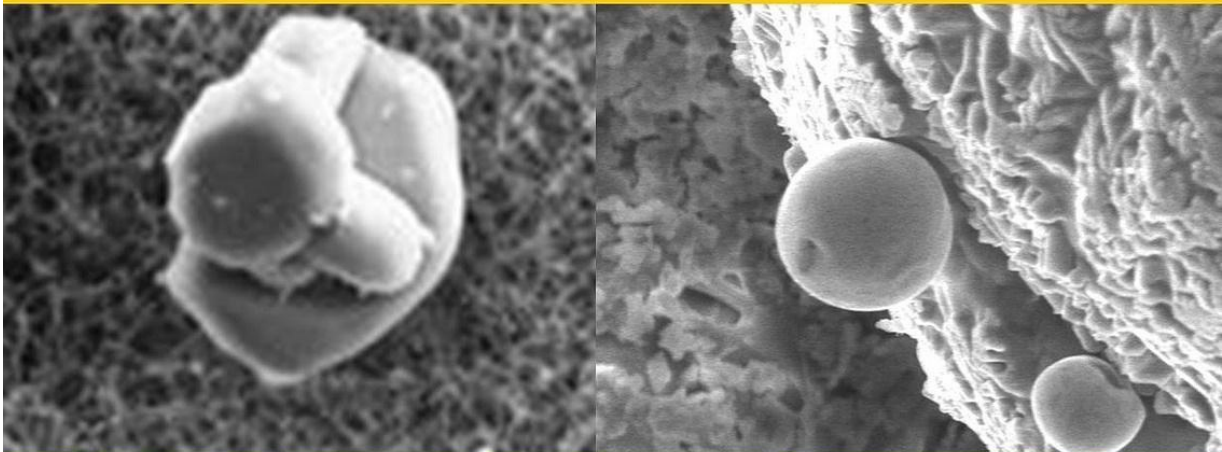

Figure 41, Non inertial Gravitating Dark Matter Black Holes and some specific astrophysical effects.

Suggestion for the origin of UFO dust particles inside the LHC at CERN: particle based Quantum Knot heating according to Quantum FFF theory.



Comparison of UFO dust particles diam. 10  $\mu\text{m}$  at CERN (left) inside ceramic tubes and on Silicon discharge globules in the lab. 100  $\mu\text{m}$  (Right)



Below (in yellow) the Quantum Knot trajectory

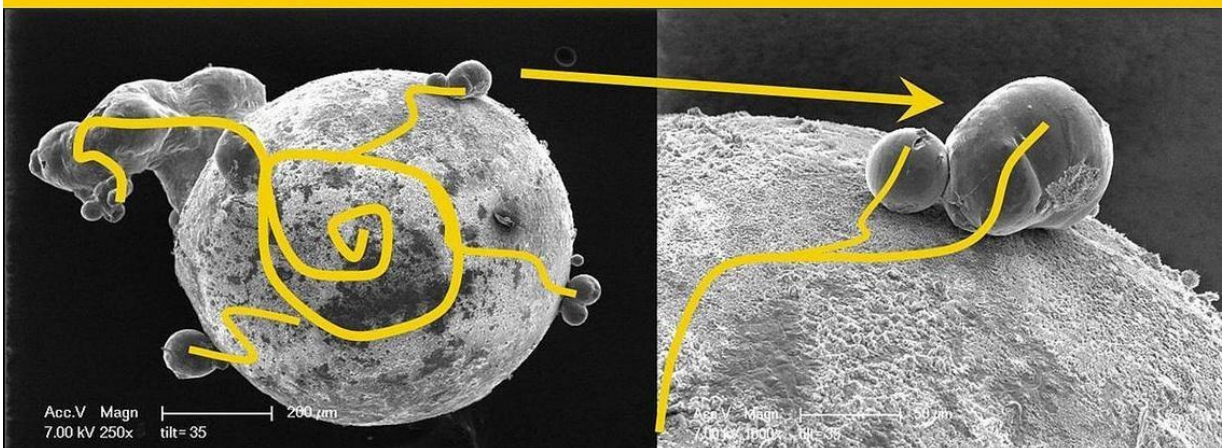

Figure 42. Magnetic Interference microscopic Higgs black holes, ( quantum Knots) with heating effects in silicon and as CERN LHC UFO dust particles.

# Multiple Horizons created around Supernova Black Holes.

Proposal for the relation between different S-Nova shapes and the external primordial black hole configuration called Herbig Haro hotspot or Stellar Anchor Black Holes (SABHs)

Different Super Nova shapes are created around two star types:  
 A: Stars with distant "dual or quadrupole Stellar Anchor Black Holes" assumed to be located in the center of a former open star cluster. (SN1987, NGC2440, Crab Nebula)  
 B: stars without SABHs. (SN1572) Our sun is equipped with two sunspot rings assumed to be of type A, with two SABHs, according to Quantum Function Follows Form Theory.

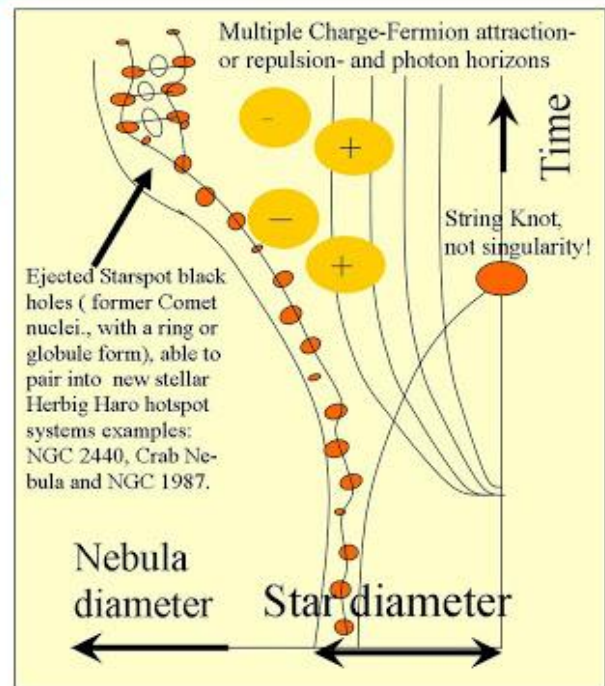
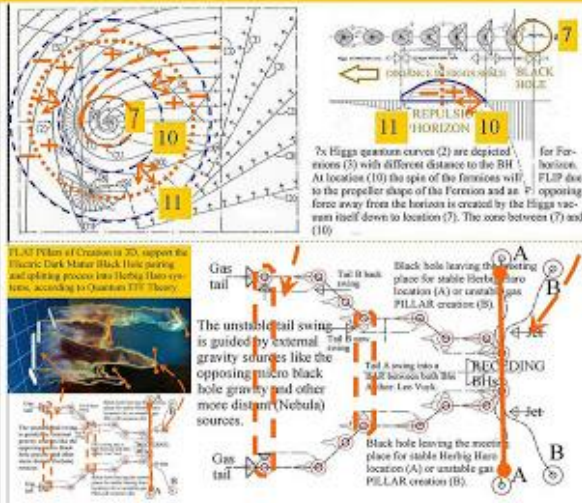
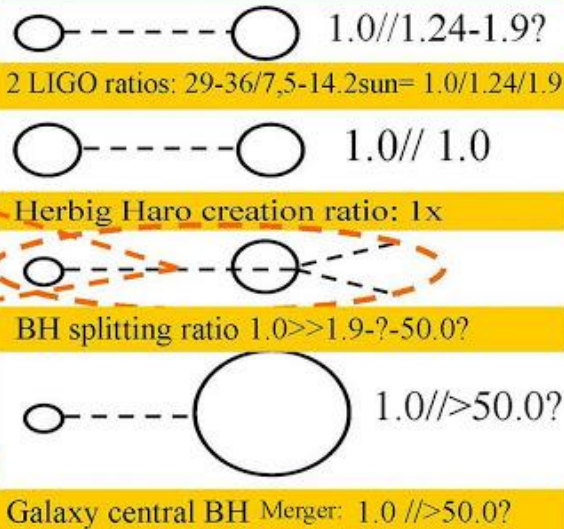
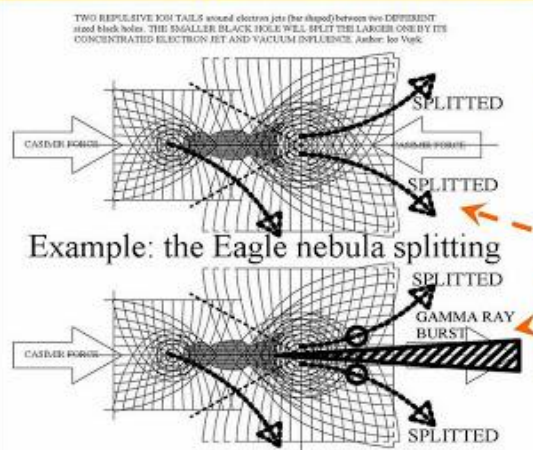

Figure 43, Super Nova Starspot Black Holes forming small Herbig Haro systems.

LIGO based Black Hole ratios and the ability to merge or split into two equal BH parts, able to create Herbig Haro systems and Gamma Ray Bursts. Such splitting systems are observed in the so called Spire part of the Eagle nebula.

The origin of Gamma Ray Bursts, by splitting black holes of different size, leaving three BHs behind. Two of them could form a Herbig Haro Object with a dumbbell structure. (Quantum FFF theory@Leo Vuyk).

Dual black hole merger nominal mass contents observed by LIGO in 2015 and 2016 resp. 29/36x and 7.5/14.2x sun masses. see: Quantum FFF Theory. The related ratios are: 1/1.24 resp. 1/1.9.



Small black holes should split larger BHs into two equal parts to create dual Herbig Haro hotspots also called bowshocks or accretion outburst sources.

Figure 44, Black Hole Ratios with absorbing consequences.

# Tripple Black Hole horizons found by NASA in accordance with Quantum FFF theory..

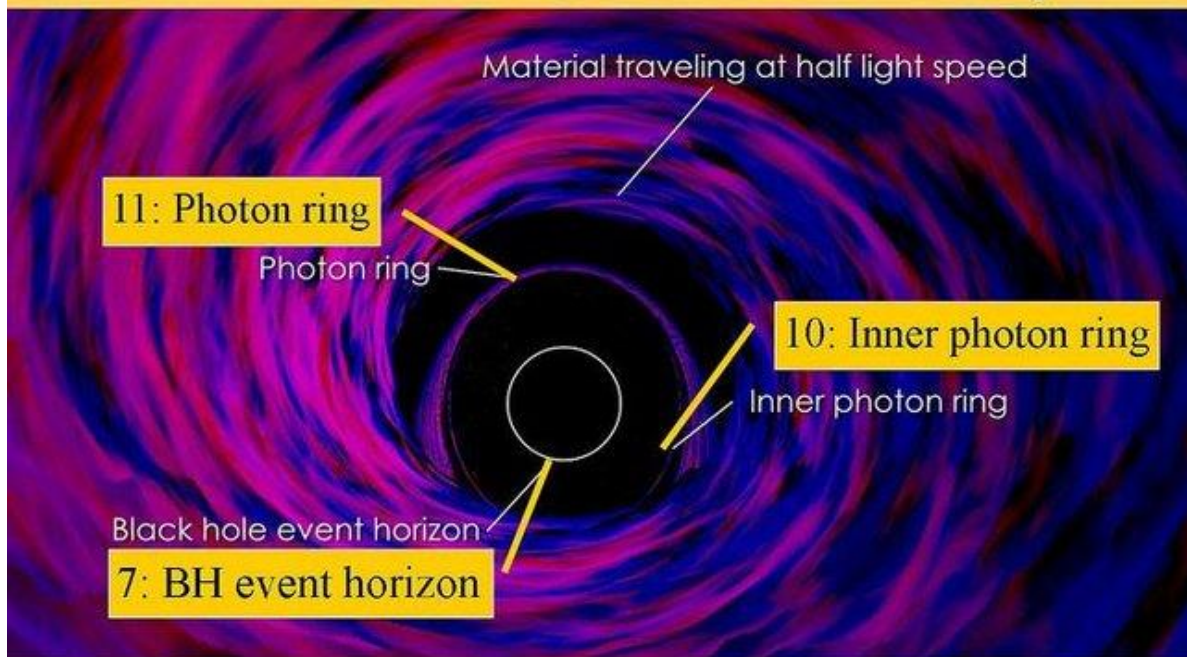

For tripple B-H horizons in Quantum FFF theory see (nrs: 7: Event horizon, 10: Inner photon ring, (10+11 =Fermion repulsion zone) 11: Photon ring )

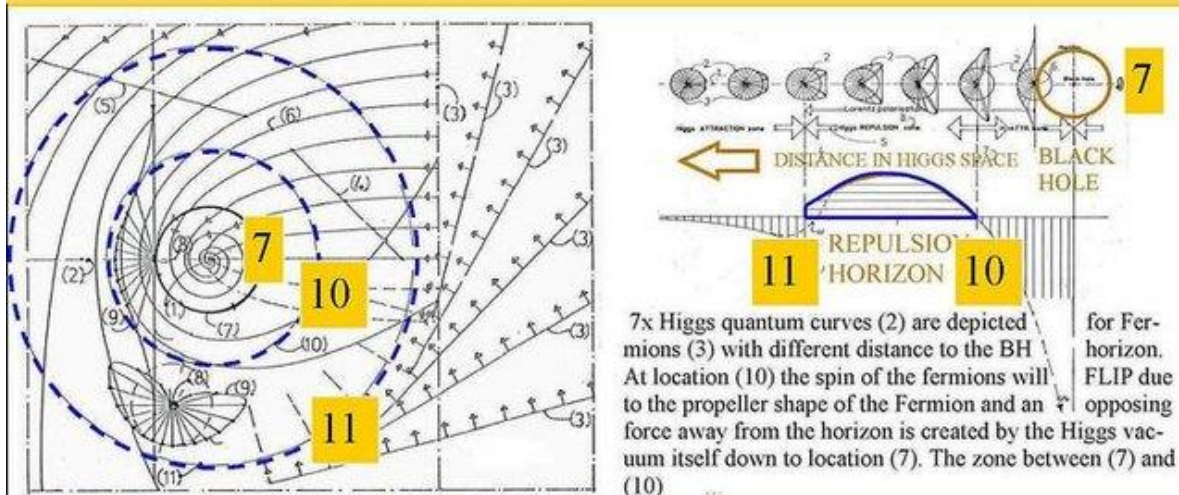

- 1: Non rotating Black hole nucleus (in 2D cross section).
- 2: Reference axis for trajectories 4,5 and 6.
- 3: Other incoming photonic/Higgs fronts (without depicted trajectories)
- 7: High photon energy collider globular shell, with intense Quantum effects like pair production ( $e^-e^+$ ). 8: test masses.
- 9: Butterfly shaped Higgs/photon Fermion pushing curves in 2D.
- 10 and 11: Fermion repulsion zone. Due to the propeller shape of the Fermions, they will experience a so called "Spin Flip" in this zone.

Figure 45, Different horizons around the Black Hole.



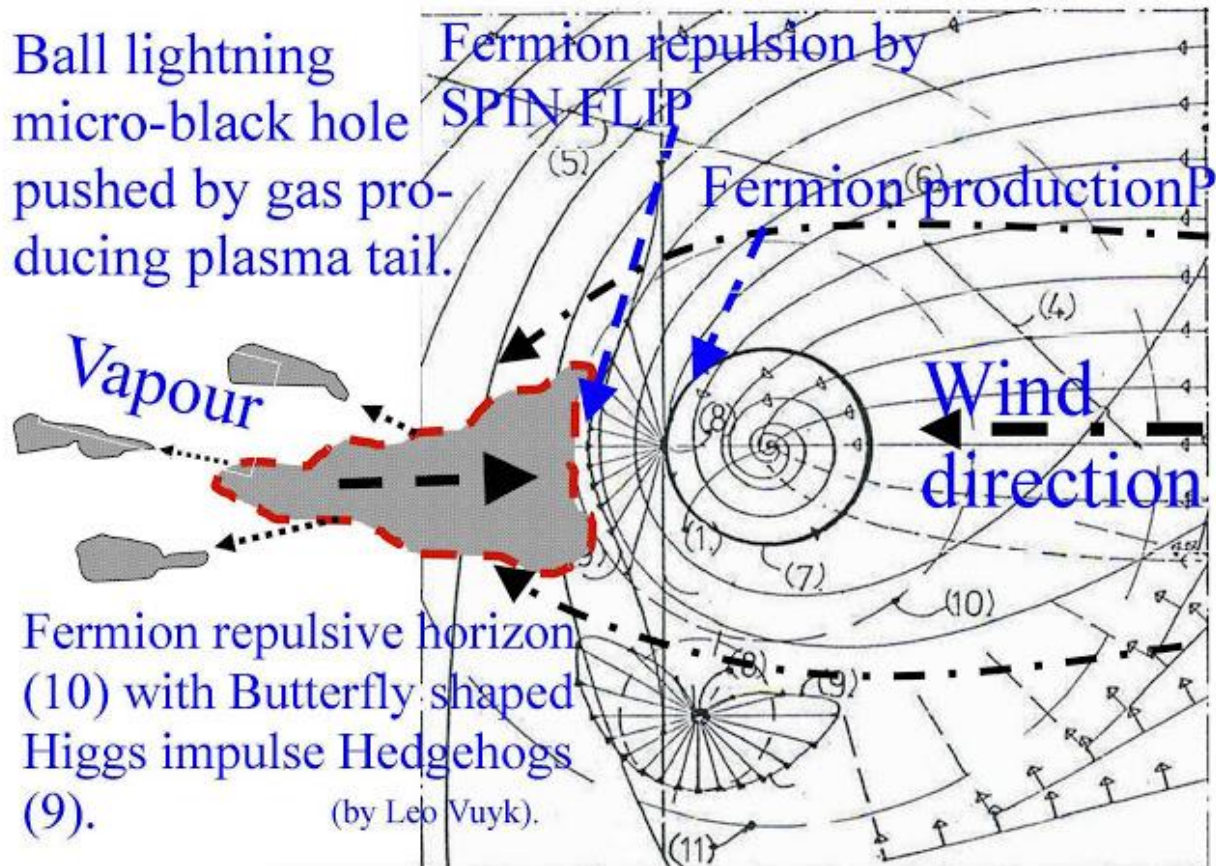

Figure 48, Details of vacuum synchrotron motion around a black hole with plasma creation and tail.

## In Addition.

According to Quantum FFF Theory, ( Function Follows Form) the FORM and microstructure of elementary particles, is supposed to be the origin of FUNCTIONAL differences between HiggsGraviton- Photon- and Fermion particles.

As a result, a NEW paradigm of splitting-,accelerating- and pairing Black Hole seems to be able to accelerate itself by a -Zero Point Energy driven-self created plasma tails ( by a new Quantum Fluctuation process), to form dumbbell systems, of two or even more black holes.

Inside Nebula these dumbbell systems are called Herbig Haro systems.

I think that Stephen Hawking did not calculate with the possibility of a chiral oscillating Higgs field vacuum lattice combined with propeller shaped Fermions. Then, due to Vacuum Chirality, Electron- and Positron propellers could both pushed away from the BH horizon after spin flip polarization at different distances, forming two charged separated spheres.

With quark ( plasma) formation in between.

Based on such a simple object ( propeller and process) oriented ontology, Black Holes could be imagined as charge splitters violating the 2e law af thermodynamics, combined with a continuous microscopic big bang plasma creation process!

The result I try to describe :

1: Black holes are the same as Dark Matter, they all consume photons, even gravitons and the Higgs field, but REPEL Fermions due to their propeller shape. They produce electric charged plasma.

- 2: Dark Energy is the oscillating ( Casimir) energy of the Higgs Field equipped with a tetrahedron lattice structure with variable Planck length..
  - 3: Quantum Gravity = Dual Push gravity= Attraction (Higgs-Casimir opposing Graviton push).
  - 4: The Big Bang is a Splitting dark matter Big Bang Black Hole (BBBH), splitting into smaller Primordial Big Bang Spinters (PBBS) forming the Fractal Lyman Alpha forest and evaporating partly into a zero mass energetic oscillating Higgs particle based Higgs field.
  - 5: Dual PBBSs hotspots, produce central plasma concentration in electric Herbig Haro systems as a base for star formation in open star clusters as a start for Spiral Galaxies.
  - 6: Spiral Galaxies will keep both Primordial Dark Matter Black Holes as Galaxy Anchor Black Holes (GABHs) at long distance.
  - 7: After Galaxy Merging, these GABHs are the origin of Galaxy- and Magnetic field complexity and distant dwarf galaxies .
  - 8: Black Holes produce Plasma direct out of the Higgs field because two Higgs particles are convertible into symmetric electron and positron (or even dual quark-) propellers (by BH horizon fluctuations).
  - 9: The chirality of the (spiraling) vacuum lattice is the origin our material universe. (propeller shaped positrons merge preferentially first with gluons to form (u) Quarks to form Hydrogen.
  - 10: The first Supernovas produce medium sized Black Holes as the base for secondary Herbig Haro systems and open star clusters.
  - 11: ALL Dark Matter Black Holes are supposed to be charge separators with internal positive charge and an external globular shell of negative charged Quark electron plasma.
  - 12: The lightspeed is related to gravity fields like the earth with long extinction distances to adapt with the solar gravity field.
  13. Quantum FFF Theory states that the raspberry shaped multiverse is symmetric and instant entangled down to the smallest quantum level. Also down to living and dying CATS in BOXES.
  - 14 Large Primordial Big Bang Spinters (PBBS) are responsible for the creation of the Lyman Alpha forest structure and first spiral galaxy forming of the universe, but they seem to be also responsible for the implosion of the universe at the end in the form of Galaxy Anchor Black Holes (GABHs) located mainly outside galaxies. see: (Quasisoft Chandra sources)
  - 15, As a consequence of 12-14, Time is always local time in combination with cyclic period time of the multiverse.
  - 16, If our material universes has a chiral left handed oscillating Higgs field, then our material Right Handed DNA helix molecule could be explained. However it also suggests that in our opposing symmetric anti-material entangled neighbor universe the DNA helix should have a Left handed spiral.
- According to Max Tegmark: in an entangled multiverse we may ask: is there COPY PERSON over there, who is reading the same lines as I do? If this copy person is indeed living over there, then even our consciousness should be shared in a sort of entangled democratic form. Then we are not alone with our thoughts and doubts, see: Democratic Free Will in the instant Entangled Multiverse.
- 17, All particles and waves should be entangled with anti-copy particles and Higgs field based waves in our opposing anti universes. Then wave particle duality and the so called one particle double slit interference could be explained by accepting that real shaped 3D photon particles only exist in their function of Gluons. However Gluons should transfer form information to



the oscillating luminiferous Higgs field ether, within about 1 cm distance from a fermion.(see: Babcock and Bergman anomaly,1964)

18, Different elementary particles have different qualities by their different complex stringy shape. Leptons and Quarks have a propeller shape with left or right handed pitch creating charge difference. Gluons, Photons and Neutrino particles have no pitch.

20 All particles can be converted to one or more Higgs particles, Lepto Quarks can be compound particles.

21 All particles are assumed to be present as Higgs particles already in the cyclic Big Bang Black Hole (BBBH) after the former multiverse has collapsed into a Big Crunch Black Hole.

22, We seem to live inside one material universal bubble of an instant entangled (Charge Parity Time) CPT symmetric raspberry bubble multiverse. Each quantum jump or wave function collapse or human choice is guided by this instant entanglement at long distant. If our material universes has a chiral oscillating Higgs field, then our material Right Handed DNA helix molecule could be explained. However it also suggests that in our opposing Anti materialmultiverse neighbour universe the DNA helix should have a left handed spiral.

According to Max Tegmark: in an entangled multiverse we may ask: is

There copy pesron over there, who is reading the same lines as I do? If this copy person is indeed living over there, then even our consciousness should be shared in a sort of democratic form,

## References;

New evidence that the highest energy cosmic rays come from beyond our galaxy.

<http://www.sciencemag.org/news/2017/09/ultra-high-energy-cosmic-rays-come-galaxiesfar-far-away>

**R.Clowes et al.** A structure in the early universe at  $z$  1.3 that exceeds the homogeneity scale of the R-W concordance cosmology, see: <http://arxiv.org/pdf/1211.6256v1.pdf> [95]

**Books:** The New God Particle and Free Will. Author: Leo Vuyk, LuLu publishers, 2008.ISBN number 978-1-4092-1031- <http://www.lulu.com/spotlight/LeoVuyk>

Quantum FFF Theory is also published in the form of POSTERS at the Flickr site: <http://www.flickr.com/photos/93308747@N05/> Numbered listing (latest) of Vixra essays by Leo Vuyk.

[http://vixra.org/author/leo\\_vuyk](http://vixra.org/author/leo_vuyk)

and on my blog: <https://bigbang-entanglement.blogspot.nl/>

Most recent papers in front.:

[140] [viXra:2007.0044](#) New Black Hole Physics, by Fermion String Repelling Black Holes. the Origin of Quick Star/Galaxy Formation.

[139] [viXra:2006.0130](#) Different Levitation Systems Observed in Big Basin UFOs, EMEC and Anti Maxwell Effect and Free Energy.

[138] [viXra:2006.0071](#) Dual Centrifugal Fermion based Synchrotron Space Thrusters, EMEC.

[137] [viXra:2006.0069](#) Dual Centrifugal Fermion based Synchrotron Space

[136] [viXra:2005.0212](#) Em Drive Space Thrusters Without Lorentz Reaction Force,

[135] [viXra:2005.0193](#) Em Drive Space Thrusters Without Lorentz Reaction Force,

- [134] [viXra:2005.0123](#) Alternative Michelson and Morley Experiment Between Two
- [133] [viXra:2004.0638](#) New Physics EM Drive Space Thrusters and Fermion
- [132] [viXra:2002.0094](#) Electric Birkeland Current Production Between Two Herbig Haro Black Holes or
- [131] [viXra:2002.0074](#) 3-Dimensional Rigid Transformer Strings with Composite Topological Strings
- [130] [viXra:2002.0073](#) The Origin of “Ultra Diffuse Galaxies” in Galaxy Cluster Centers and the Start Inside the Contracting Abell 520.
- [129] [viXra:1911.0346](#) The Cyclic Undivided Raspberry Multiverse.
- [128] [viXra:1909.0417](#) The Magic Fermion Repelling Stringy Fuzzball Black Hole, the Origin of a Cyclic Raspberry Multiverse.
- [127] [viXra:1907.0250](#) The Conscious Readiness Potential Ratio Multiverse with Transactional Interpretation of J. Cramer.
- [126] [viXra:1905.0244](#) EM Drive Thruster by Anti Maxwell Dual Monopole Tubular Interference Field Reduction Around a Conductor.
- [125] [viXra:1905.0123](#) The Conscious Undivided Multiverse,
- [124] [viXra:1904.0599](#) The Origin of Universal Structure: Herbig Haro -Electric Dark Matter Black Hole- Systems.
- [123] [viXra:1903.0447](#) Black Hole Creation and Destruction of the Cyclic Conscious Multiverse.
- [122] [viXra:1903.0347](#) Visualizing Subatomic Particles as Building Blocks of the Universe.
- [121] [viXra:1903.0102](#) What Is Wrong With Physics?
- [120] [viXra:1902.0349](#) The Electric Universe by Electric Dark Matter Big Bang Black Holes of Quantum FFF Theory.
- [119] [viXra:1902.0201](#) Novel Ideas About Dark Matter and the SuSy Multiverse.
- [118] [viXra:1901.0426](#) 4x and 3x Interference for Stringy Bose Einstein Black Hole Production.
- [117] [viXra:1812.0228](#) Equal Sized Rigid String Based New Black Holes do not Merge But, Form Herbig Haro Systems.
- [116] [viXra:1812.0095](#)  $E = \text{not } Mc^2$  in Massless Black Holes According to Quantum FFF Theory.
- [115] [viXra:1811.0125](#) Testing Proposals for Human Free Will in the Raspberry Multiverse, Local Entanglement and M&M Lightspeed.
- [114] [viXra:1811.0002](#) Big Bang Energy out of Nothing, or a Compressed Rigid String Nucleus
- [113] [viXra:1809.0189](#) Apparent Violation of the Second Law, Around Black Hole Nuclei and Other Quantum Knots.
- [112] [viXra:1807.0437](#) Preference for Dual Herbig Haro Black Hole Consumption by the Central MW Black Hole, Leaving Plasma Jets Behind.
- [111] [viXra:1806.0368](#) A Fifth Force Vacuum Dipole Repeller, Needed to Create All Attraction Forces Even Around Black Holes in Quantum FFF Theory.
- [110] [viXra:1806.0298](#) Expanding Earth, by Growing Water based Crashed Comet core.
- [109] [viXra:1806.0068](#) Primordial Electric Dark Matter Black Holes Outside Galaxies Responsible for the Creation and Contraction of a Cyclic Multi-Universe.
- [108] [viXra:1805.0541](#) Tidal Star Disruption Events (TDE) by Fermion Repelling Black Holes in Quantum FFF Theory.
- [107] [viXra:1805.0307](#) Fulgurite Created by Lightning Bullet Also Known as Ball Lightning, According to Quantum FFF Theory

[106] viXra:1804.0138 Dark Matter Black Hole Galaxy Hierarchy According to Quantum FFF Theory.

[105] viXra:1803.0100 Free Will Readiness Potential Ratios, the Key for a Multiverse Number Calculation.

[104] viXra:1803.0093 Skyrmion Interference Black Holes, Photonic Molecules, Ball Lightning, Micro Comets, Sprite-Fireballs and Sunspots According to Quantum FFF Theory.

[103] viXra:1801.0121 Quantum FFF Theory, a Conscious String Theory with Different Vacuum Trajectories for Axion-Higgs Field/ Photons Respectively Fermions, Gluons and Bosons.

[102] viXra:1801.0040 A Consciousness Theory of Everything based on Rigid Transformable Strings, Instantly Entangled Between 8 or 12 CP Symmetric Universal Bubbles.

[101] viXra:1712.0349 Tabby Star's Support for New Physics Starspot Black Holes of Quantum FFF Theory.

[100] viXra:1712.0122 The Massless Axion-Higgs Vacuum Rigid String Particle, Even in Micro and Macro Dark Matter Black Hole Nuclei.

[99] viXra:1711.0443 The Semi Classical Model of Quantum FFF Theory based on Symmetric Transformable Entangled Rigid Strings.

[98] viXra:1711.0379 The Raspberry Shaped Multiverse, Pulsating Between Big Crunch and Big Bang, Based on Rigid Transformable Massless Axion Higgs Particles.

[97] viXra:1711.0327 The Einstein Cross Lensing Effect Explained by the Quadruple Dark Matter Formation Process of Edge-on Spiral Galaxies, According to Quantum FFF Theory.

[96] viXra:1711.0237 Higgs Particle Based SIMPs for Ancient and Future (Stone) Cutting Technology.

[95] viXra:1711.0112 Higgs Quantum Knots is Dark Matter is Black Holes or: Higgs Dark Matter Black Holes.

[94] viXra:1710.0257 Kilonova Merger Black Holes as the Origin of Dark Matter Black Hole Halo Population.

[93] viXra:1710.0115 Grand Unification of 4 Forces According to the Quantum FFF Model by di-Monopole Repeller Rigid String Pressure.

[92] viXra:1710.0050 Emergent Gravity by Dipole Repeller Rigid String Pressure the Origin of Quantum Gravity and Non Inertial Black Holes.

[91] viXra:1710.0034 The New Physics Black Hole Nucleus: Gravity Without Inertial Mass Effects.

[90] viXra:1709.Dual Solar Anchor Black Holes or Herbig Haro Hotspots, the Origin of Quick Star Formation.

[90] viXra:1708.0170 Action Without Reaction Symmetry for em Space Propulsion Thruster Technology.

[89] viXra:1708.0083 Dipole Repeller Gravity Effects at Different Universal Scales as the Origin of Large Scale and Local Quantum Gravity and Hubble Redshift.

[88] viXra:1707.0224 The Magic of the New Electric Dark Matter Black Hole on Earth and Space.

[87] viXra:1707.0189 Black Hole Nuclei as a Bunch of Rigid Transformable Higgs Strings Splitting by Relative Small Companion Mergers or Decreased Vacuum Pressure.

[86] viXra:1706.0490 The Origin of "Dead" Galaxies.

[85] viXra:1706.0420 Mass in Motion According to Quantum FFF Theory.

[84] viXra:1706.0413 Magnetic Monopole Test to Demonstrate the Existence of a Anti Maxwell Dead Zone Around a Current in a Wire. [83] viXra:1705.0153 A Different Black Hole Horizon Interpretation Leading to Entropy Reduction and Violation of the Second Law.

[82] viXra:1705.0026 The Magic of Life- and Matter Creating Self Propelled Electric Dark Matter Black Holes Guided by a Holographic Entangled symmetric Multiverse System.

[81] viXra:1704.0272 Interference Black Holes, Ball Lightning, Micro Comets, Sprite Fireballs and Sunspots According to Quantum FFF Theory.

[80] viXra:1704.0150 The Origin of Life and the Need for a Rigid String Propeller Fermion Model Combined with a Chiral Vacuum Lattice and Micro Interference Black Holes

[79] viXra:1704.0133 2. Signals for Retarded Single Big Bang Black Hole Nucleus Splitting and Pairing into Dual Black Hole Herbig Haro Systems

[78] viXra:1704.0047 Bohmian Double Slit Interpretation by Dual Entangled Universes, and the Benjamin Libet Experiment. [77] viXra:1704.0003 A Testable CP Symmetric Multiverse Model by Extended Experiments, Done by the Late Benjamin Libet in 1964.

[76] viXra:1702.0109 CP Symmetry Between Material and Anti Material Copy Universes Combined with Local- and Multi-Universal Cycle Time.

[75] viXra:1702.0040 The Alternative Origin of Hubble Redshift : Vacuum Absorption by black holes as a Support for Quantum Dipole Repeller Gravity and a Contracting Universe.

[74] viXra:1701.0633 Local and Multi-Universal Cycle Time According to Quantum FFF Theory. (FFF= Function Follows Form)

[73] viXra:1612.0365 John S. Bell Was Right: “How to Teach Special Relativity” and Atomic Pear Shaped Contraction.

[72] viXra:1612.0026 Democratic Free Will and Telepathy in the Instant Entangled

[71] viXra:1611.0226 Galaxy Cluster Merging and Vacuum Absorption by black holes as a Support for Quantum Dipole Repeller Gravity and a Contracting Universe.

[70] viXra:1611.0101 Observed Dual Higgs Mass 124-126 Gev and the Chirality of the Vacuum Lattice.

[69] viXra:1611.0031 Rigid String Cosmology with a Massless AxionHiggs Oscillating Photon Vacuum Lattice and Massive Quantum Knots.

[68] viXra:1611.0005 Electric Dark Matter Black Holes in the Moon (Orientale Basin)

[67] viXra:1609.0407 New Physics Elements in the Quantum Function Follows Form Model.

[66] viXra:1608.0329 God Seems to Play Dice with Dual Entangled Pinball Machines in a Super symmetric (Susy) Multiverse

[65] viXra:1607.0376 Axion-Higgs 3-Dimensional Rigid Transformable Strings and the Compound 650 GeV Z-Z Decay into Quarks/Lepto quarks.

- [64] viXra:1605.0257 Reaction Less Drive by Anti Maxwell Dead Zone Around a Wire.
- [63] viXra:1604.0372 Herbig Haro Hotspots or Bow shocks Are the Origin of Star Formation, not the Result as the Mainstream Suggest. [62] viXra:1604.0229 Er=epr in the Super symmetric Cyclic Multiverse and in the Lab Without Strange Cats.
- [59] viXra:1505.0101 The Origin of Bok Globules and Molecular Clouds, Splitting and Pairing Electric Dark Matter Black Holes.
- [58] viXra:1503.0186 Primordial Dark Matter Black Holes Outside Galaxies Responsible for the Creation and Contraction of a Cyclic Universe? 22
- [57] viXra:1503.0097 Quantum FFF Theory, Poster News 4.2
- [56] viXra:1502.0086 Parity and Chirality as a Base for Quark-Gluon Plasma and Dust Creating Black Holes and the Beginning and End of Time..
- [55] viXra:1411.0039 Quantum FFF Theory, Poster News 2
- [54] viXra:1410.0039 Evidence for Dark Matter Black Hole Based Plasma, Dust and Ice Production Inside Comets Like 67P,C-G. and the Growing Earth.
- [53] viXra:1409.0164 The O'Connell Effect in Eclipsing Binaries Explained by Mass Related Light Speed Extinction Distances (Lasof) of Stars and Even Planets.
- [52] viXra:1407.0001 Evidence for Evaporating Dark Matter Particles in Silicon Fireballs.
- [51] viXra:1406.0076 Galaxy Formation and Evolution According to Quantum FFF Theory.
- [50] viXra:1406.0019 Quantum FFF Theory Proposals for Some Unsolved Physics Problems.
- [49] viXra:1405.0224 Dual Star Ejection in Open Star Clusters by the Central Star.
- [48] viXra:1404.0151 Future Free Energy of New Physics Ball Lightning Black Holes, the Origin of a Super Social Society or the Opposite? [47] viXra:1404.0002 Proposal for the Origin of Unexpected Large BModes Found in the Bicep2 Measurements.
- [46] viXra:1402.0132 Reconciliation of GR and QM by a New GravityBlack Hole and Lightspeed Model Called Quantum- FFF Theory. [45] viXra:1402.0044 The Impossible Zero Point Electric Black Hole as the Origin of New Physics even for Comets like 67P,C-G.
- [44] viXra:1401.0115 Calabi Yau Shaped Double Fermion Spin States.
- [43] viXra:1401.0071 Democratic Free Will in the Instant Entangled Multiverse.
- [42] viXra:1312.0143 The Navel Cord Multiverse with Raspberry Shape, a Super Symmetric Entangled 12 Fold Bubble Universe.
- [41] viXra:1312.0076 Are Sunspots Made of Gravitating Dark Matter Black Holes?

[40] viXra:1310.0101 The New Nuclear Magic Number (34) Explained by the Polar Coaxial Ring System of Quantum FFF Theory.

[39] viXra:1310.0059 The Semi Relativistic Higgs Field Aether with Mass Related Lightspeed Adaptation.

[38] viXra:1309.0081 New Physics by Table Top Experiments.

[37] viXra:1308.0083 23 The Raspberry Shaped Super Symmetric Multiverse

[36] viXra:1307.0068 Quantum Function Follows Form Theory, the Small Scale, Posters part 1.

[35] viXra:1307.0067 Quantum Function Follows Form Theory, the Large Scale, Posters part 2.

[34] viXra:1306.0218) Dark Matter UFO Dust Particles or Quantum Knots in the LHC at CERN ?

[33], viXra:1306.0065 The Splitting Dark Matter- Black Hole- Big Bang and the Cyclic Multiverse.

[32], viXra:1305.0140 Quantum FFF Theory Experiments, a Summary [31], viXra:1305.0041 The Shnoll Effect Explained by Quantum FFF Theory.

[30], viXra:1304.0022 The Self Organizing Universe in the Carina Nebula.

[29], viXra:1303.0211 Hubble Redshift Combined with Universal Contraction is Possible.

[28], viXra:1303.0053 Micro Birkeland Currents Between Two RF Generated Plasma Balls in the Laboratory.

[27], viXra:1302.0172 Silicon Based Ball Lightning Globule Structures and Signs for Accumulation and Retarded Decrease of Tunneling Energy Bullets.

[26], viXra:1301.0088 Two or Three Large Quasar Groups (LQGs) Located at the Start of Two or Three Lyman Alpha Systems and a Part of the Raspberry Multiverse?

[25], viXra:1301.0050 Dwarf Galaxies and Their Relation with Dark Matter Based Galaxy Anchor Black Holes (Gabhs).

[24], viXra:1210.0177 Instant Broglie Bohm Pilot Waves, the Origin of All Entanglement Effects in the Lab and Wavefunction Collapses in Our Universe as Related to Our Opposing Anti-Copy Universe(s) According to Quantum FFF Theory.

[23], viXra:1209.0092 New Dark Matter Black Holes and a New Dark Energy Higgs Field, Lead to a Bouncing CP Symmetrical Multiverse, and New Experiments.

[22], viXra:1209.0061 Birkeland Currents, Sunspots, Comets and Ball Lightning Originated by New Paradigm Dark Matter Black Holes. [21], viXra:1209.0030 Majorana and Sterile Neutrino Solutions in the Quantum-FFF Model.

[20], viXra:1208.0031 Clumpy Dark Matter Around Dwarf Galaxies a Support for an Alternative Black Hole Theory According to the Quantum Function Follows Form Model.

[19], viXra:1202.0091 Earth Magnetic Monopole Array Field Interaction with Cyclotron – Synchrotron Electrons and Muon Conversion Used for Levitation Systems.

- [18], viXra:1201.0092 Earth Magnetic Monopole Array Field Interaction with Cyclotron Electrons used for Levitation Systems.
- [17], viXra:1112.0065 24 LHC Signals Between 121-130 GeV Interpreted with Quantum-FFF Theory
- [16], viXra:1111.0096 Reconciliation of QM and GR and the Need for a Pulsating Entangled CPT Symmetric Raspberry Shaped Multiverse.
- [15], viXra:1111.0061 Black Hole Horizon Curvature Dependent Balance Between Plasma Creation and e-e+ Annihilation in Quantum FFF Theory.
- [14], viXra:1108.0036 Artificial Ball Lightning Production and Exploitation Device for Zero Point Electric Energy Usage.
- [13], viXra:1108.0006 Mass in Motion in Quantum FFF Theory.
- [12], viXra:1104.0083 Quantum FFF Theory in Posters.
- [11], viXra:1104.0044 Ball Lightning, Micro Comets, Sprite-Fireballs and X-Ray/gamma Flashes According to Quantum FFF Theory.
- [10], viXra:1104.0002 Stellar Anchor Black Holes as the Remnants of Former Herbig Haro Objects
- [9], viXra:1103.0097 ZPE Zero Point Energy Examples Around Black Holes.
- [8], viXra:1103.0068 Function Follows Form, at the Quantum Scale and Beyond.
- [7], viXra:1103.0024 Quantum Gravity and Electro Magnetic Forces in FFF Theory
- [6], viXra:1103.0015 Wavefunction Collapse and Human Choice-Making Inside an Entangled Mirror Symmetrical Multiverse.
- [5], viXra:1103.0011 An Alternative Black Hole, Provided with Entropy Decrease and Plasma Creation
- [4], viXra:1103.0002 3- Dimensional String Based Alternative Particles Model
- [3], viXra:1102.0056 Experiments to Determine the Mass Related Lightspeed Extinction Volume around massive objects.
- [2], viXra:1102.0054 Atomic Nuclear Geometry Based on Magic Number Logic. [1], viXra:1102.0052 Construction Principles for Chiral "atoms of Spacetime"

=====

=====