

Treo model, Structure and working of universe; Increasing deformation of unit space matrix and formation of all elements.

Ashok Saxena, Sumit Majumdar*, Surekha saxena, Ashwarya Saxena, Amit Saxena.

*Department of Physics & Astrophysics, University of Delhi. Delhi, India.

Abstract

Universe is made up of one object of creation, which are *strings* named as Treos in this proposed treo model. All treos are of Planck least length and present only in one dimension of length. Treos are of two types, as *free* treos they form all packets of photons and matter, while as *bound* treos they get arranged alternately with curled up voids to construct omnipresent uniform space matrix of universe. ^[5] Thus it forms our space or multilayered cubical spaces of Planck length. ^[4a]

All bound treos of space matrix vibrate simultaneously at *Planck frequency* or S times per second, which decides S number as cosmic code of our universe. This S number carves our universe and calibrates *unit space*, *unit time*, and *unit energy*. ^[3]

S number of treos is one quanta energy, which is quantum of unit action and the value of reduced Planck constant while its angular momentum is Planck constant as calculated. ^[4 b].

mail2ashoksaxena@gmail.com

*sumit@physics.du.ac.in

Our Universe is Quantum Pendulum universe and EM energy or Mass energy increases only in steps, at each of \sqrt{S} quantum levels in each dimension, in units of S free trees in first dimension (of length), $\sqrt{S} \times S$ free trees in second dimension (of length and breadth), and $S \times S$ free trees in third dimension (of length, breadth and depth).

To neutralize these loads equal numbers of bound trees are converted in kinetons. By action of one free tree load, one bound tree vibrating in S plains (in 360 degree), now starts vibrating S times only in direction of load along with S vibrations per second, thus it converts in one kineton and space gets contracted.

Unit space matrix is a cube of S bound trees on its each side, and it is functional unit of space matrix which reacts and increasingly deforms, with conversion of equal number of bound trees in kinetons with increasing load at each of \sqrt{S} quantum levels in all three dimensions of space. ^[4d]

Along with increase of one quanta EM energy at each next quantum level, the increased angular momentum as $h\nu_1, h\nu_2, h\nu_3$ and $h\nu_4 \dots h\nu_{\sqrt{S}}$, produces equal number of EM waves of all \sqrt{S} type of photon packets (which comprises EM spectrum). ^[4c]

In second dimension the increasing mass energy in units of $\sqrt{S} \times S$ free trees (of one unit electron) at each of \sqrt{S} quantum levels adds one new layer (one sub shell with $2n - 1$ orbitums) in one graviton column (kinetic column of second dimension).

Each one orbitum made up of S kinetons rotates once in one second to support/ neutralizes one quanta or S free treos load ^[2]. To neutralize each quanta exerted load, equal number of orbitums are formed in each shell, which are present at each one apex bound treo along its RC wave length (the length of spread of this elementary particle packet) of *de broglie's matter wave* thus formed at this quantum level.^[3e]

All 120 elements, grouped in 7 periods of periodic table, are created by one by one filling of electrons (with each increase of protons at nucleus) in preformed orbits in increasing number of sub shells of 4 shells, which are formed at four atomic quantum levels in each vortexes of deformation and counter deformation of unit space matrix. One, two, three and four sub - shells are in shells which form at 1, 2, 3, 4 th atomic quantum level in each vortex, and thus total 8 shells are formed in both vortexes. ^[3f]

In third dimension $S \times S$ free treos (one unit mass or Planck mass) increases at each of \sqrt{S} quantum levels and this increasing mass energy exerts a load of square number of unit masses at its one gravitational centre of body.

The increased load at each next n th quantum level is neutralized by addition of one new co-centric spiral layer (with $2n - 1$ gravitons) in one kinetic coloumn (electron black hole) of third dimension. Each graviton is associated with one graviton coloumn formed by S^2 kinetons, which are converted from S^2 bound treos present in one full sheath of unit space matrix.

(A) Deformation in One Dimensions of Length.

(To support all \sqrt{S} types of Photon packets; from unit Photon to gamma photon.) ^[12]

We know that the field of EM force is formed by transverse EM waves in which electrical and magnetic vectors are placed at 90 degrees to each other. According to proposed model the *electrical vector is manifested by free treos*

in packet, while vertically placed revolving and supporting kinetic columns generate magnetic field.

The load of any photon packet is shared on space matrix. Any photon packet will spread along its wave length (of *S bound tree/number of quanta in photon packet*) and the load of any number of free trees (according to its photon packet density) at each apex bound tree, is supported by one sub kinetic column having equal number of kinetons.

At **first quantum level (n=1)**, one quantum mass energy (S free trees in unit photon) spreads on S number of apex bound trees along its wave length. Now at each apex bound the *load is one free tree*, which is supported by one kinetic column having one kinton in its first layer.

At **second quantum level (n=2)**, two quanta mass energy photon packet (double the mass energy) spreads on S/2 apex bound trees in wave length (spreads on half length) and exert a '*load*' of 4 or 2^2 free trees. At each apex bound in wave length, the load of 4 free tree is supported by 4 kinetons in one kinetic column which have one kinton in its first layer and three kinetons i.e. $2 \times 2 - 1 = 3$ ($2n - 1$) in its second layer.

At **third quantum level (n=3)**, three quanta photon packet spreads on S/3 apex bound trees in wave length and exert a '*load*' of 9 or 3^2 free trees at each apex bound tree, which is supported by one kinetic column of 9 kinetons, having one kinton in its first layer, three kinetons in its second layer and five kinetons i.e. $3 \times 3 - 1 = 5$ ($2n - 1$) in its third layer. Thus, total 3^2 kinetons ($1 + 3 + 5 = 9$) are in this three layered kinetic column.

Similarly, at **Fourth quantum level (n=4)**, for Four quanta photon packet spreads on S/4 apex bound trees in wave length and exert a '*load*' of 16 or 4^2

free treos at each apex bound treo, which is supported by one kinetic coloumn of 16 kinetons, having one kinton in its first layer, three kinetons in its second layer, five kinetons in third and seven kinetons i.e. $4 \times 2 - 1 = 7$ ($2n - 1$) in its fourth layer. Thus, total 4^2 kinetons ($1+3+5+7 = 16$) are in this four layered kinetic coloumn.

Similarly, at all \sqrt{S} **quantum levels** ($n=\sqrt{S}$), for \sqrt{S} quanta photon packet one \sqrt{S} layered kinetic coloumns is formed, at each apex bound treo along its \sqrt{S} bound treos wave length.

To support the increasing load of n^2 free treos at n^{th} quantum level, one new layer of $2n - 1$ kinetons is added in each Sub kinetic coloumn (present on each apex bound treos in wave length) to complete one n layered sub kinetic coloumn, having equal number of n^2 kinetons (square of the number of layers in coloumn).

1. First Quantum Level of First Dimension (Deformation of 1 Row of S Bound Treos)

S free treos in unit photon packet spreads on S bound treos length on one full row of unit space matrix. It will exert a uniform load of one free treo to be supported by S number of one layered sub kinetic coloumns in this wave length. Thus, total of S free treos in unit photon packet are supported by *one row of S kinetons* of unit space matrix (Fig 1).

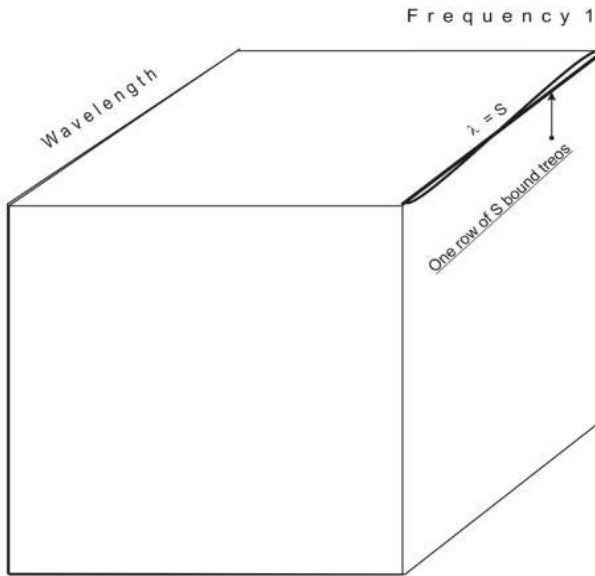
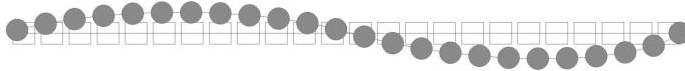

Figure 1: First quantum level in deformation of first dimension in length
 First Quantum Level of first dimension

(Diagrammatic Representation)

One EM wave is shown in Fig 2. One free tree is supported by one kinton in one layered sub kinetic columns in wavelength.

One quanta (S free treos) 'Unit photon packet'
Deformation in Length of Unit space Matrix
(All 'S' type of photons in EM spectrum have integrals of one quanta mass energies)



Frequency of EM wave = 1 = Number of Kineton layers in each sub kinetic coloumn
 = Number of quanta mass energy in packet = Number of EM waves per second.

(Wave) length of photon packet = S number of sub kinetic Coloumns in wave length



load - one free treo (as S free treos in photon packet spreads on S bound treos in wave length)

One free treo load is supported by one kineton (deformed bound treo) in one layer

Side by side placed Sub-kinetic coloumns (Transverse section)
of EM wave



Ground Energy fluctuations with time (in each kineton in first layer of kinetic coloumn)

diagramatic representation

Figure 2: First quantum level in deformation of first dimension in length

2. Second Quantum Level of First Dimension

(Addition of 3 Rows in Deformation)

Two quanta (or $2 \times S$ free treos) are mass energy of two quanta photon packet. And according to formula S bound treo/2 quanta mass energy in packet = S/2 bound treos is its wave length.

Thus, $2 \times S$ free treos in photon packet, uniformly spread on S/2 bound treo wave length will exert a uniform load of 4 free treo at each of S/2 apex bound treos in wave length, where its 4 free treo load is supported by 4

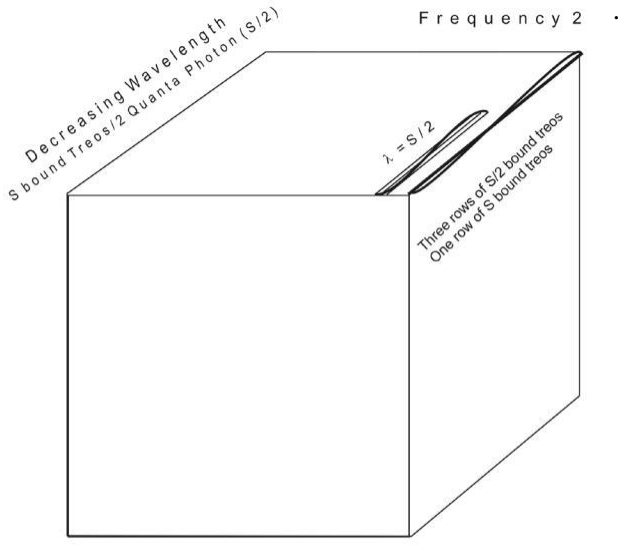

(Diagrammatic Representation)

Figure 3: Second quantum level in deformation of first dimension in length: additional deformation of 3 rows of S/2 bound treos is required to form all sub kinetic coloumns.

Kinetons (1 + 3 kinetons) or 2^2 kinetons, in each of two layered S/2 sub kinetic coloumns (Fig. 4), Thus, to form all sub kinetic coloumns in wave length, 1 row of S bound treos is already deformed and now *3 new rows of S/2 bound treos will deform.* (Fig. 3)

While 2 quanta mass energy is in this two quanta photon packet and 2 layers are in its each sub kinetic coloumn, 2 is frequency of this wave and with 2 unit angular momentum it will form 2 EM waves in one second.

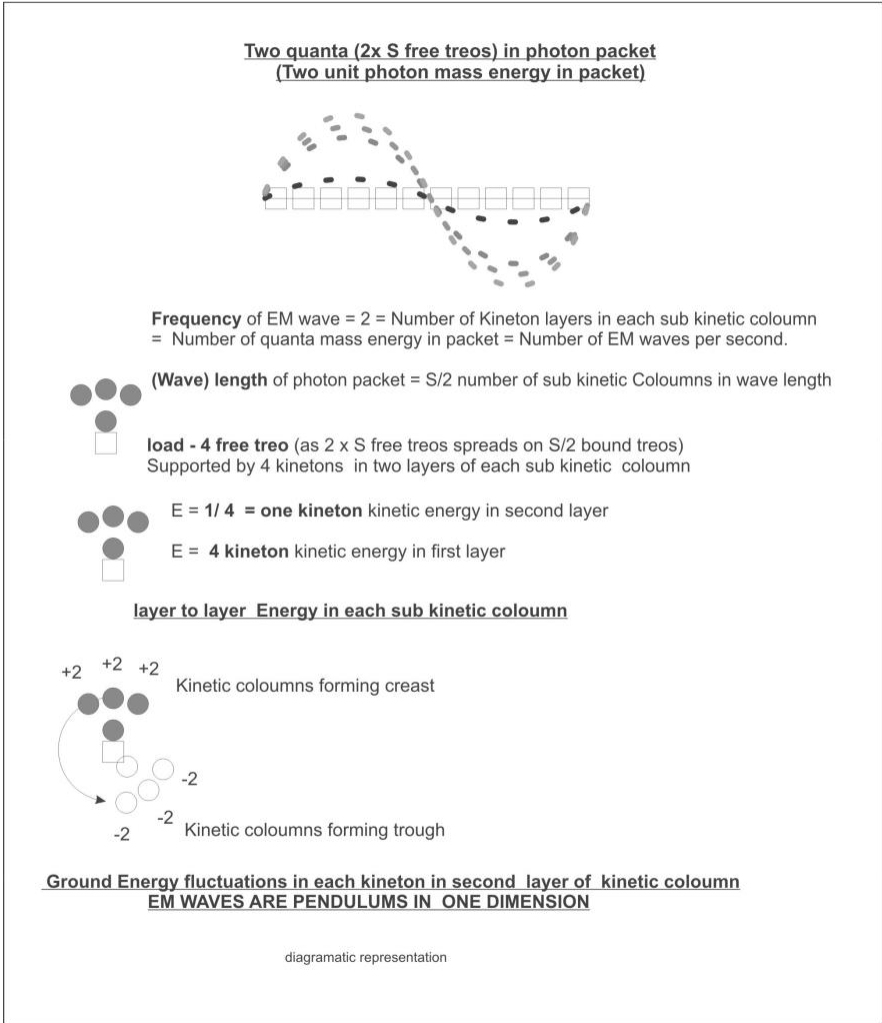

Figure 4: Second quantum level in deformation of first dimension in length

One wave is shown in Fig. 4. 4 free treos are supported at each apex bound treo by 4 kinetons in two layers in each sub kinetic coloumn.

3. Third Quantum Level of First Dimension

(Addition of 5 Rows in Deformation)

Three quanta ($3 \times S$ free treos) is mass energy of three quanta photon packet.
And according to formula S bound treos/3 quanta mass energy in packet = $S/3$
bound treos is wave length.

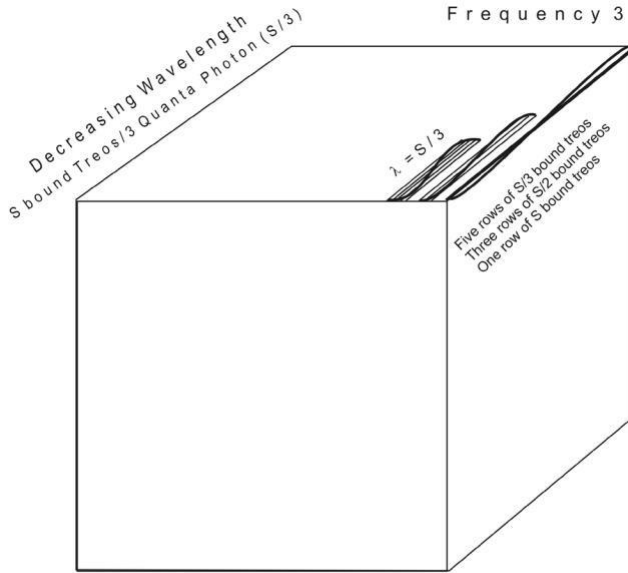

Third quantum level of First Dimension

(Diagrammatic Representation)

Figure 5: Third quantum level in deformation of first dimension in length: additional deformation of 5 rows of $S/3$ bound treos is required to form all sub kinetic columns.

One row of S bound treos and 3 rows of $S/2$ bound treos are already deformed; Now 5 new rows of $S/3$ bound treos are added and thus at each apex bound tree along its $S/3$ bound tree wave length, it forms one sub kinetic column of 3^2 kinetons ($1 + 3 + 5 = 9$ kinetons) in its 3 layers.(Fig. 5)

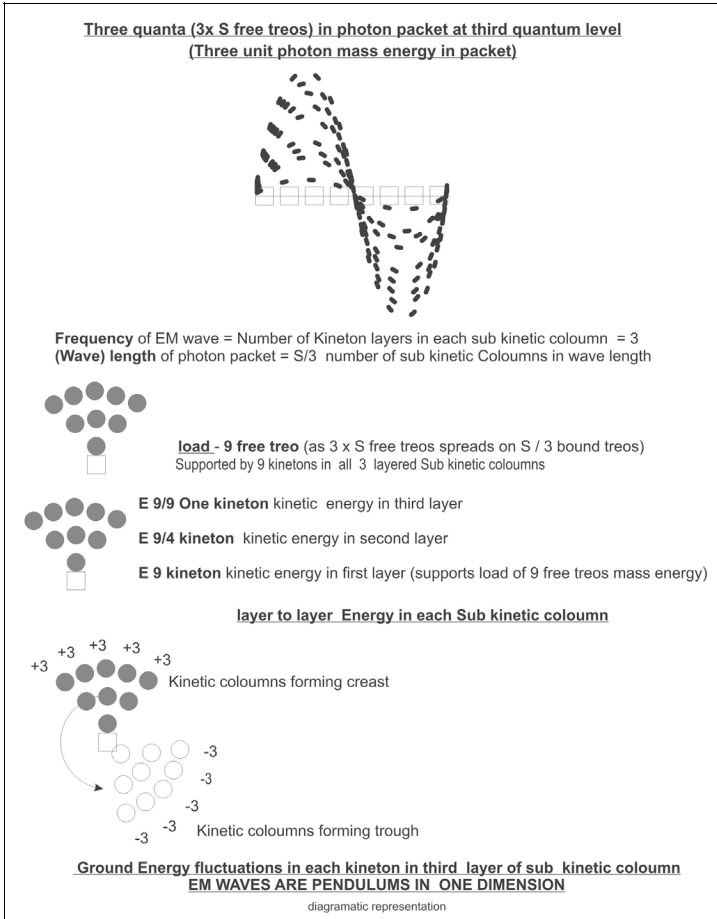

Figure 6: Third quantum level in deformation of first dimension in length

Formation of one EM wave at third quantum level is shown in Fig. 5. All sub kinetic coloumns are formed, by 1 row of S bound treos, 3 rows of S/2 bound treos which are already deformed and *now additional 5 rows of S/3 bound treos will deform.*

Thus total $3 \times S$ free treos in three quanta photon packet, spread uniformly on S/3 bound treo wave length and exert a uniform load of 9 free treo at each of these S/3 apex bound treos, where its 9 free treo are supported by 9 Kinetons in each sub kinetic coloumn (9 kinetons = 1 + 3 + 5 kinetons in three layers). (Fig.6)

While 3 quanta mass energy is in this three quanta photon packet and 3 layers are in its each sub kinetic column, 3 is frequency of this wave and with 3 unit angular momentum, it will form 3 EM waves in one second.

4. Fourth Quantum Level of First Dimension

(Addition of 7 Rows in Deformation)

Four quanta (or $4 \times S$ free treos) are mass energy of four quanta photon packet. And according to formula S bound treos/4 quanta mass energy in packet and thus $S/4$ bound treos is wave length.

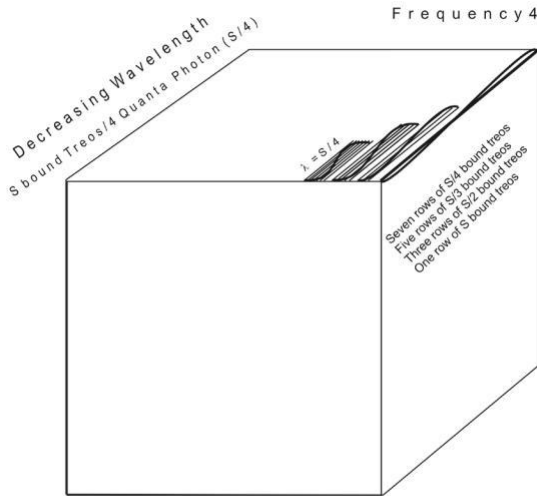

Fourth Quantum Level of first dimension
(Diagrammatic Representation)

Figure 7: Fourth quantum level in deformation of first dimension in length: additional deformation of 7 rows of $S/4$ bound treos is required to form all sub kinetic columns.

One row of S bound treos, 3 rows of $S/2$ bound treos and 5 rows of $S/3$ bound treos are already deformed /contracted. *Now 7 rows of $S/4$ bound treos length are added* and thus at each apex bound treos along $S/4$ wave length one sub kinetic column form of $1+3+5+7= 16$ kinetons in 4 layers. (Fig. 7)

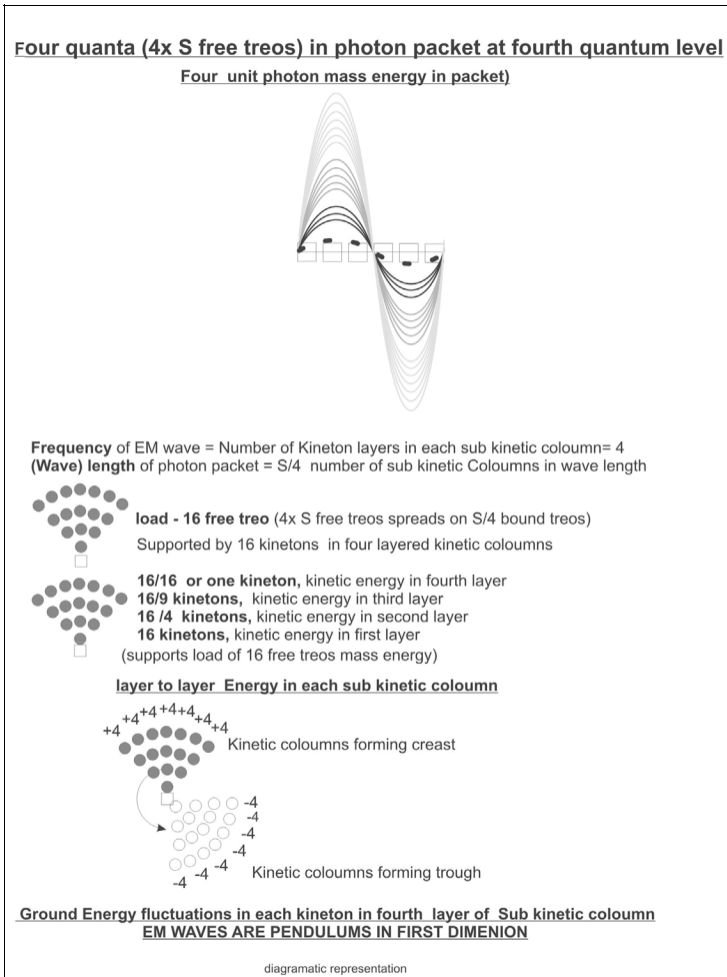

Figure 8: Fourth quantum level in deformation of first dimension in length

Thus total $4 \times S$ free treos in photon packet, uniformly spread on $S/4$ bound treo wave length, exert a uniform load of 16 free treo at each of these $S/4$ apex bound treos in wave length where its 16 free treo are supported by 16 kinetons in each sub kinetic coloumn (16 kinetons = $1+3+5+7$) or 4^2 kinetons, in four layers. (Fig.8)

One EM wave, with one kinton in first layer, 3 kintons in second, 5 kintons in third layer and 7 kintons are in each sub kinetic coloumn, which are present at each apex bound treo, in $S/4$ bound treo wave length; (Fig.8).

While 4 quanta mass energy is in this four quanta photon packet and 4 layers are in its each sub kinetic coloumn, 4 is frequency of this wave and with 4 unit angular momentum, it will form 4 EM waves in one second.

5. Last or \sqrt{S} Quantum Level of First Dimension (Addition of New $2\sqrt{S}-1$ Rows)

The gamma photon packet at last quantum level is of \sqrt{S} quanta (or $\sqrt{S} \times S$ free treos) mass energy. And according to formula S bound treo / \sqrt{S} quanta mass energy in packet; $S/\sqrt{S} = \sqrt{S}$ **bound treos wave length.**

If we see total deformation by \sqrt{S} quanta (or $\sqrt{S} \times S$ free treos) mass energy, one row of S kintons, 3 row of $S/2$ apex bound treos wave length, 5 rows of $S/3$ bound treos and 7 rows in $S/4$ bound treo length and to continue, so on $2n - 1$ row of S/n bound treos are added at each n^{th} quantum level and get deformed, finally **new $2\sqrt{S}-1$ rows, each of $\sqrt{S} = (S/\sqrt{S})$ bound treos** length are added at last \sqrt{S} quantum level. (Fig.9)

$\sqrt{S} \times S$ free treos in gamma photon packet uniformly spreads on \sqrt{S} bound treo wave length and thus exert a uniform load of S free treo or one quantum at each of \sqrt{S} apex bound treos in wave length. Where these S free treo are supported by S Kintons in each sub kinetic coloumn. Each sub kinetic coloumn is made up of **S kintons, in \sqrt{S} layers.**

While \sqrt{S} quanta is mass energy in biggest photon packet and \sqrt{S} layers are in its each sub kinetic column, \sqrt{S} is frequency of this wave and thus with \sqrt{S} units angular momentum, \sqrt{S} waves will form in one second

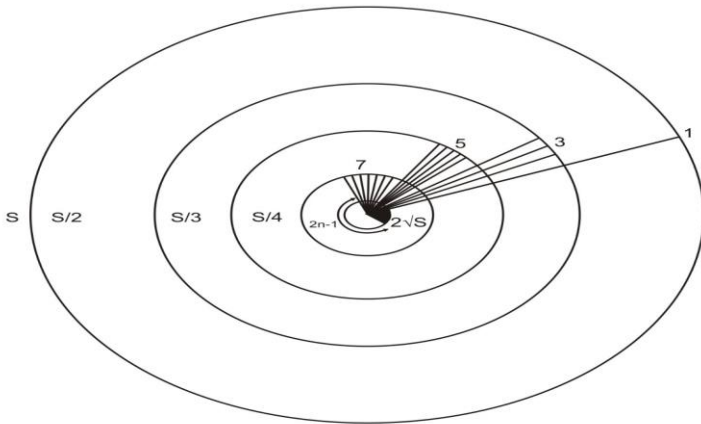
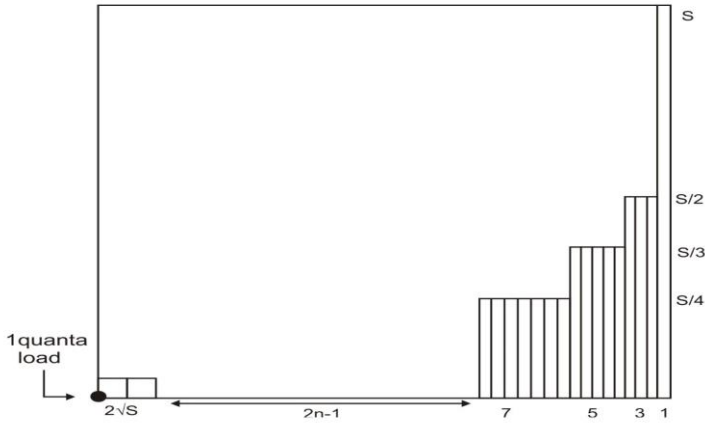

Figure 9 a & 9b : \sqrt{S} quantum level in deformation of first dimension in length: additional deformation of $2\sqrt{S}-1$ rows of \sqrt{S} bound trees each are required to form all sub kinetic columns (not to scale)

Deformation of first dimension in one unit time (of 1 second).

As per column geometry $2n-1$ rows are deformed at each n^{th} quantum level; therefore in complete deformation of first dimension, from first to \sqrt{S} quantum levels, total S rows (n^2) will be deformed.

As observed all Photons ranging from 1 to \sqrt{S} quanta mass energy forms equal number of 1 to \sqrt{S} waves in one second, to support itself for one second. Thus each row will totally deform by all waves of this photon which will form in one second.

With increase of one quanta in photon packet, one layer increases in all kinetic columns, angular momentum increases by one unit and photon packet rotates once more in one second.

Load of each one quanta EM energy (is supported by its one rotation of packet which form one EM wave) or one quanta mass energy (by one orbitum) by its one rotation in unit time of one second.

Each graviton supports one unit mass (S quanta; mass energy) is supported by one matter wave having S orbitum in \sqrt{S} sub shells in each shell at last quantum level) ; in unit time of one second (S vibrations).

Load of Multiple unit mass bodies are supported by equal number of gravitons. While each quantum energy is supported (by its one rotation) from S directions by S vibrations which occur in one second.

As multiple units mass body moves it divides its load in its length of spread on each apex bound tree, in one second. This has great impact on our day to day life 'that is why our airplane could fly and take off (leave aside the Bernoulli's theorem). The angular momentum of moving body reduced load is also less 'so moving bicycle does not destabilize and fall (while standing bicycle falls).

At **First quantum level (n=1)**, the deformation of S kinetons in 1 row for one quanta photon packet will form one wave in one second at first quantum level. One quanta photon packet takes 1 rotation (and form 1 wave) in one second to be supported for one second.

At **second quantum level (n=2)** three full rows (2n-1) each having S kinetons will be used to form two waves of S/2 bound tree wave length in one second. Two quanta photon packet will take 2 rotations (and forms 2 waves) in one second to be supported for one second.

At **third quantum level (n=3)** five full rows (2n-1) each having S kinetons will be used to form three waves of S/3 bound tree wave length in one second. Three quanta photon packet will take 3 rotations (and forms 3 waves) in one second to be supported for one second.

At **fourth quantum (n=4)** level full seven rows (2n-1) each having S kinetons will be forming four waves of S/4 bound trees wave length in one second. Four quanta photon packet will take 4 rotations (and forms 4 waves) in one second to be supported for one second.

Thus gamma photon of \sqrt{S} quanta mass energy is supported in one second, by \sqrt{S} rotations of this photon packet on \sqrt{S} waves. e.g. The gamma photon

will remain supported on its S/\sqrt{S} wave length by S/\sqrt{S} vibrations, for S/\sqrt{S} second time only on its one wave. To support it for S vibrations i.e. for one second, total S vibrations ($= S/\sqrt{S}$ vibrations in one wave $\times \sqrt{S}$ waves in one second) for \sqrt{S} waves it will require full $2\sqrt{S} - 1$ rows each having S kinetons.

\sqrt{S} EM waves of gamma photon, (together with moving deformation at lower quantum levels) will use total S kinetons in all S rows of first dimension, to support \sqrt{S} quanta mass energy of this gamma photon in unit time of one second.

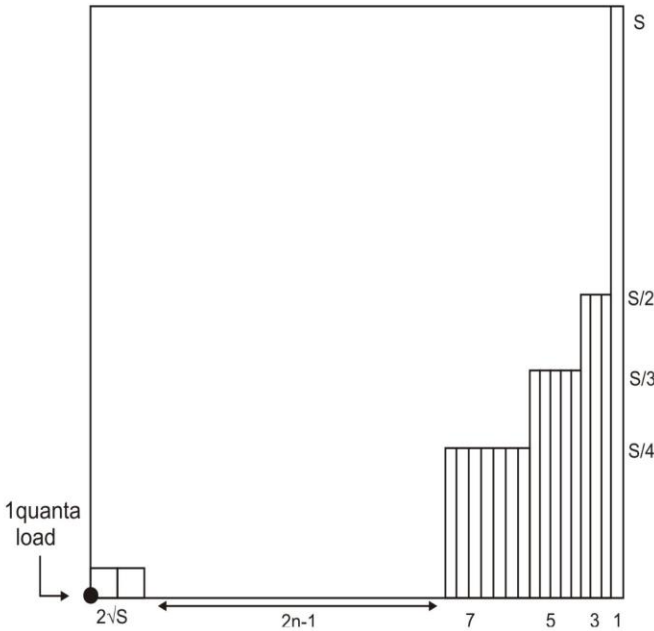

Figure 9c : \sqrt{S} quantum level in deformation of first dimension in length: additional deformation of $2\sqrt{S}-1$ rows of \sqrt{S} bound trees each are required to form all sub kinetic columns (not to scale). \sqrt{S} bound tree square having S kinetons will form one orbitum in electron wave and \sqrt{S} bound tree square having S kinetons will form one orbitum of a positron.

(B). Deformation in Two Dimensions of Length and Breadth

Packet of one unit electron is \sqrt{S} quanta mass energy (or $\sqrt{S} \times S$ free treos).

At each next quantum level, of second dimensional deformation, this \sqrt{S} quanta mass energy of one unit electron packet increases (**as one unit**) up to \sqrt{S} quantum level to produce all energetic electrons, all elementary particles, nucleons, atoms, molecules and body up to one unit mass.

These mass energy packets of all elementary particle get uniformly spread and exert a equal 'load' on all apex bound treos in its successively reducing RC wave length (thus gradually contracting). To neutralize this load on each apex bound treo, one shell (kinetic coloumn) at each apex bound area will form as one bound treo thick disc, generated from one layer of unit space matrix.

Thus this RC wave length (S bound treos / n quanta mass energy in packet), gives *S/n bound treo height to this vertically placed packet.*

In start of deformation of second dimension, the mass energy packets at 1st, 2nd, 3rd and 4th quantum level will gradually shrink along with reducing RC wave length of \sqrt{S} , $\frac{1}{2}\sqrt{S}$, $\frac{1}{3}\sqrt{S}$, $\frac{1}{4}\sqrt{S}$ apex bound treos length.

In deformation of second dimension, the 'coloumn geometry' will remain same (*$2n-1$ units* in its any n^{th} layer, while n^2 are in n layered coloumn*) but sub kinetic coloumn, layers of sub kinetic coloumn and kinteton of first dimension are replaced by shell, sub shells and orbitum respectively in second dimensional deformation, as they are formed in two-dimensional geometry of second dimension in one plane.

Breadth of particle:

At any n^{th} quantum level $2n-1$ orbitums (each of S kinetons) in n^{th} sub shells of each shell are added (in place of $2n-1$ kinetons in any newly added n^{th}

layers in sub kinetic coloumn). Thus In each shell (kinetic coloumns), one new sub shell added at each next quantum level, will also add \sqrt{S} bound treos layers in its increasing radius, with the addition of one new row of $2n-1$ small squares (as each square of \sqrt{S} bound treos on its two sides also have \sqrt{S} bound treos along its diagonal). (see Fig 10).

Thus If total radius of disc of shell, is ‘n’ number of bound treos layers at any quantum level; then the number of quanta mass energy in this packet is also ‘n’; also ‘n’ is the Frequency of wave.

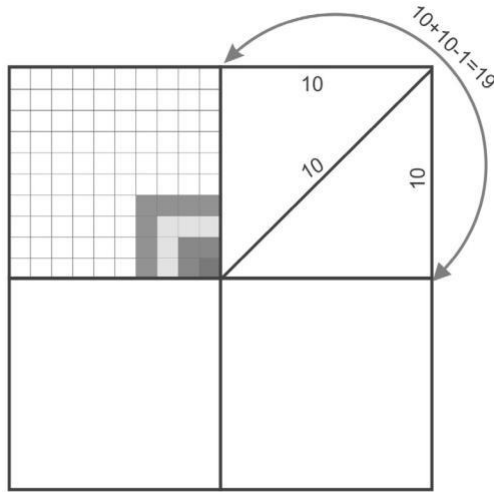

Figure 10: (e.g. for understanding of unit space matrix geometry); A small area of undeformed space matrix can be divided in four squares , representing all four directions in two dimensional geometry. Each portion will have 100 blocks (small squares) which will be arranged like above diagram in space matrix. Each have 10 blocks in length, 10 in breadth and 10 in diagonal. Two sides in each row deformed diagonally from one corner will have $(2n-1)$ blocks e.g. at periphery it has total 19 blocks $(= 10 + 10 - 1)$.

The unit space matrix (it is for calculation) can be counted from any point on space matrix where the load is applied. It will start from the point of exerted load as one upper corner of one unit space matrix. With reducing

wave length from \sqrt{S} bound trees of a unit electron to one bound tree of 'one unit mass'.

With one shell formed in one sheet, the wave involves \sqrt{S} sheets of one unit space matrix, on its RC wave length at first quantum level for one unit electron mass (and in gradually reducing number of shells and sheets involved with decreasing wave length at each next quantum level for all elementary particles) up to just one last sheet at last \sqrt{S} quantum level, at one unit gravitational centre for one 'unit mass'. Thus in total it will involve all S sheets, for formation of \sqrt{S} quantum levels in depth in second dimensional deformation.

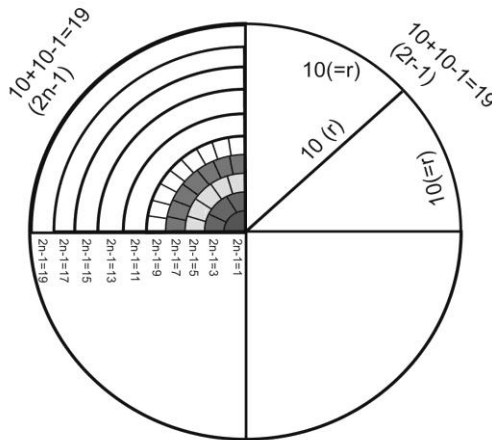

Figure 11: (e.g. for understanding of unit space matrix geometry); This one portion of one sheet of space matrix shown in Fig. 25 contract to form kinetic column of shell as shown, and it will have 100 kinetons (which came from 100 small squares) and will be arranged like above diagram. $1+3+5+7+9+11+13+15+17+19 = 100$ in 10 layered column, (or $2n-1$ squares in each row and n_2 are in any n layered column).

A. First Quantum Level

‘ \sqrt{S} quanta mass energy’ in unit electron packet exert one quantum load. This ‘one quantum load’ is exerted at each of \sqrt{S} apex bound trees in its RC wave length, and is supported by each of \sqrt{S} shells, which are vertically placed and form in \sqrt{S} sheets of unit space matrix.

Each rotating shell has one sub shell and one orbitum (present in all shells in wave length and will jointly form **1 s orbit**) made up of S kinetons, which comes from S bound trees in first square deformed (of \sqrt{S} bound trees are in its one side of square and S bound trees in its area) present in first row. Fig 14.

B. Second Quantum Level

$2 \times$ ‘ \sqrt{S} quanta mass energy’ in two unit electron packet exert 4 quantum load or $(2)^2$ quanta load, at each of $\sqrt{S}/2$ apex bound trees in its RC wave length according to its ‘electron packet density’ (as mass energy doubles on half wave length).

This 4 quanta load at each of $\sqrt{S}/2$ apex bound trees in its RC wave length is supported by $\sqrt{S}/2$ shells which are placed vertically and are formed in $\sqrt{S}/2$ sheets of one unit space matrix, one new sub shell will be added.

Each rotating shell has two sub shells; with one orbitum in first sub shell and 3 orbitums in second sub shell (while each orbitum is made up of S kinetons), jointly form 3 *p* orbits.

First sub shell with one orbitum is at \sqrt{S} bound tree radius, while second sub shell has all its 3 orbitums at $2 \times \sqrt{S}$ bound tree radius. One orbitum of first sub shell gets its S kinetons from one square (of \sqrt{S} bound trees are in its one

side of square and S bound treos in its area) in first row, while all 3 orbitums of second sub shell gets 3 S kinetons from 3 squares present in second row deformed. (Fig. 18)

C. Third Quantum Level

$3 \times \sqrt{S}$ quanta mass energy' in three unit electron packet exert 9 quantum or $(3)^2$ quanta load, equal to its 'electron packet density' (as mass energy triples on one third wave length). This 9 quanta load at each of $\sqrt{S}/3$ apex bound treos in its wave length is supported by each of $\sqrt{S}/3$ shells (in RC wave length) which are placed vertically and are formed in $\sqrt{S}/3$ sheets of unit space matrix.

Each rotating shell has three sub shells; with one orbitum in first sub shell, 3 orbitums in second sub shell and 5 orbitums in newly added third sub shell will jointly form 5 orbits.

First sub shell with one orbitum is at \sqrt{S} bound treo radius, while second sub shell has all its 3 orbitums at $2 \times \sqrt{S}$ bound treo radius and third sub shell has all its 5 orbitums (present in all shells in wave length will jointly form **5d orbits**) at $3 \times \sqrt{S}$ bound treo radius. One orbitum of first sub shell gets its S kinetons from one square in first row, while all 3 orbitums of second sub shell gets 3 S kinetons from 3 squares present in second row deformed and all 5 orbitums of third sub shell gets 5 S kinetons from 5 deformed squares present in third row (Fig 22).

D. Fourth Quantum Level

$4 \times \sqrt{S}$ quanta mass energy' in four unit electron packet exert 16 quantum or $(4)^2$ quanta load, equal to its 'electron packet density'. This 16 quanta load at each of $\sqrt{S}/4$ apex bound treos in its wave length is supported by each of $\sqrt{S}/4$ shells (in RC wave length) which are placed vertically and are formed in $\sqrt{S}/4$ sheets of unit space matrix.

Each rotating shell has four sub shells; with one orbitum in first sub shell, 3 orbitums in second sub shell, 5 orbitums in third sub shell and 7 *f* orbitums are in newly added fourth sub shell.

With every increase of ' \sqrt{S} quanta mass energy' (in one unit electron) at each next quantum level, one new sub shell of \sqrt{S} bound treo layers are added. Thus concentric \sqrt{S} bound treo layers increases at each next n^{th} quantum level, and with one new sub shell added, while the total radius of shell will become $n \times \sqrt{S}$ bound treo layers. From 1 small square of \sqrt{S} bound treos sides, present at corner of one sheet of unit space matrix S bound treos from its S bound treo area, generates 1 S kinetons which form one orbitum. (Fig. 15)

At second quantum level with the deformation of new \sqrt{S} bound treos layers (of second row) which increases diagonally it will form second sub shell, and now 4 S bound treos in 4 S bound treo area (1 square + 3 squares) in each of shell get converted in to 4 S kinetons to form 4 orbitums. (Fig. 19)

At third quantum level with the deformation of new \sqrt{S} bound treos layers diagonally (of third row) it will form third sub shell, and now 9 S bound treos in 9 S bound treo area (1 square + 3 squares + 5 squares) in each of shell get converted in to 9 S kinetons to form 9 orbitums. (Fig 23)

At Fourth quantum level with the deformation of new \sqrt{S} bound treos layers diagonally (of fourth row) it will form fourth sub shell, and now 16 S kinetons from 16 S bound treo area (1 square + 3 squares + 5 squares + 7 squares) in each shell get converted in to 16 S kinetons to form 16 orbitums (Fig 27).

Thus the area of each shell increases at next quantum level by addition of $(2n-1)$ quanta i.e. 3S bound treos area from 3 squares in second sub shell, 5S bound treos area from 5 squares in third sub shell and 7S bound treos area from 7 squares in fourth sub shell from which it forms additional 3, 5 and 7 supporting orbitums in 2nd, 3rd and 4th sub-shells in each shell.

All identical energy orbitums 1+3+5+7 orbitums present in *s, p, d, f* sub shells of each shell (one below other in all shells) at fourth quantum level will jointly form 16 orbits, at this fourth quantum level. (Fig 27)

We can note that at 1st, 2nd, 3rd and 4th quantum level, one quantum, 2² Quanta, 3² Quanta, 4² Quanta load are respectively present at each apex bound treo in RC wave length of packet.

At first quantum level 1 quantum load is supported by 1 orbitum in one first sub shell, at second quantum level, with 3 new orbitums added in one new second sub shell, $1 + 3 =$ total 4 orbitums supports 4 quanta or 2² Quanta load, at third quantum level it adds 5 orbitums in one new third sub shell, $1 + 3 + 5 =$ total 9 orbitums in three sub shells support 9 quanta load or 3² quanta load and then seven orbitums in fourth new sub shell $1 + 3 + 5 + 7 =$ total 16 orbitums are in first, second, third and fourth sub shells of each shell (which

are placed at each apex bound tree along its wave length) and supports 16 quanta load or 4^2 Quanta load.

One orbitum will support one quantum mass energy by its one rotation in one second.

At subsequent each next n^{th} quantum level the elementary particle packet which condenses, will have $n \sqrt{S}$ quanta mass energy (thus all elementary particle described and not described in standard model, are formed), and n^2 quanta is load (with the increasing mass and decreasing RC wave length) at each apex bound tree which is supported by addition of $2n-1$ orbitums in n^{th} new sub shell, in each shell which are present on each apex bound tree along its S/n bound trees RC wave length.

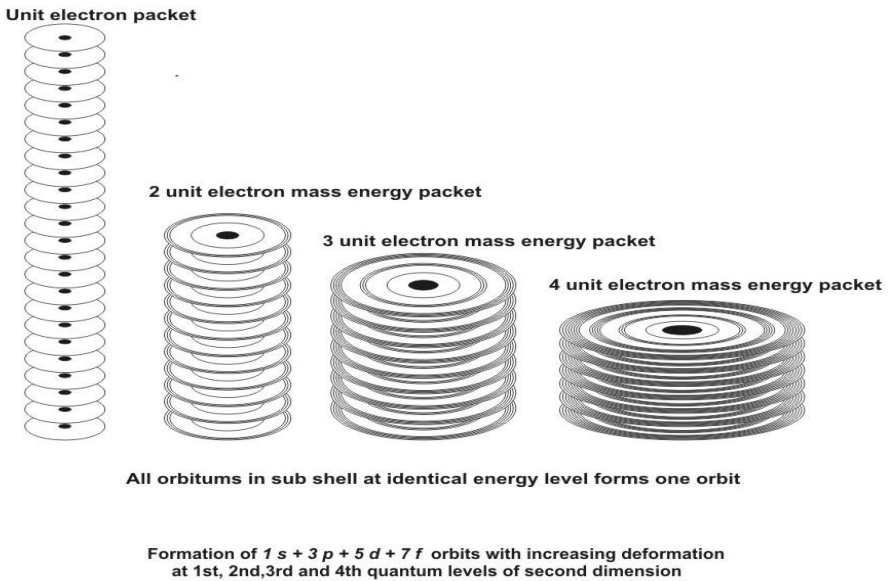

Figure 12: $1s$, $3p$, $5d$ and $7f$ orbits are formed in four sub shells in each shell per Column geometry at first, second, third and fourth quantum level in deformation of Second dimension.

At n^{th} quantum level with the deformation of new \sqrt{S} bound trees layers diagonally it will increase the area of shell by $2n-1 \times S$ bound trees, which

will add $2n-1 \times S$ kinetons for $2n-1$ new orbitums, which are formed in one new n^{th} sub shell.

One unit mass (Planck mass; 2.176×10^{-8} Kg) is maximum load* (roughly the weight of flea egg) which can be supported at one bound tree on space matrix anywhere in universe at its one unit gravitational centre or at one graviton by its one graviton column (full kinetic column of second dimension).

As the successively decreasing RC wave length finally reduces to one bound tree (1 bound tree wave length = S bound trees/ S quanta mass energy in one unit mass); for one-unit mass which is supported at one graviton (i.e. one apex bound tree) by one graviton column.

In this graviton column in one last sheath deformed (1 bound tree RC wave length) at last \sqrt{S} quantum level, it will add one new sub shell with $2\sqrt{S} - 1$ ($2n-1$) orbitums. At this last \sqrt{S} quantum level, in its all \sqrt{S} sub shells (in last S^{th} sheet) total S orbitums will be in last shell, which are formed by S^2 kinetons from last full sheet of unit space matrix, and will support S quanta load of unit mass (of S quanta mass energy or of S^2 free trees).

The wave at graviton is of S frequency; so all S orbitums in this last sheet will rotate around graviton, at the speed of light to complete their one rotation in one second. Thus S quanta load is supported by a graviton.

Along with, in deformation at lower quantum levels total \sqrt{S} number of matter waves is present, revolving at gradually reducing speeds, one at each of \sqrt{S} quantum levels with complete deformation of two dimensions.

Theme of Deformation-

One free tree is supported by one kineton and thus each quanta mass energy (S free trees) is supported by one orbitum made up of S kinetons. Each orbitum rotates once in one second to support its load of one quanta mass energy.

1 First Quantum level in deformation of second dimension (Deformation of \sqrt{S} bound tree layers and S kinetons in 1 small square)

The unit Electron spreads its \sqrt{S} quanta mass energy (or $\sqrt{S} \times S$ free trees

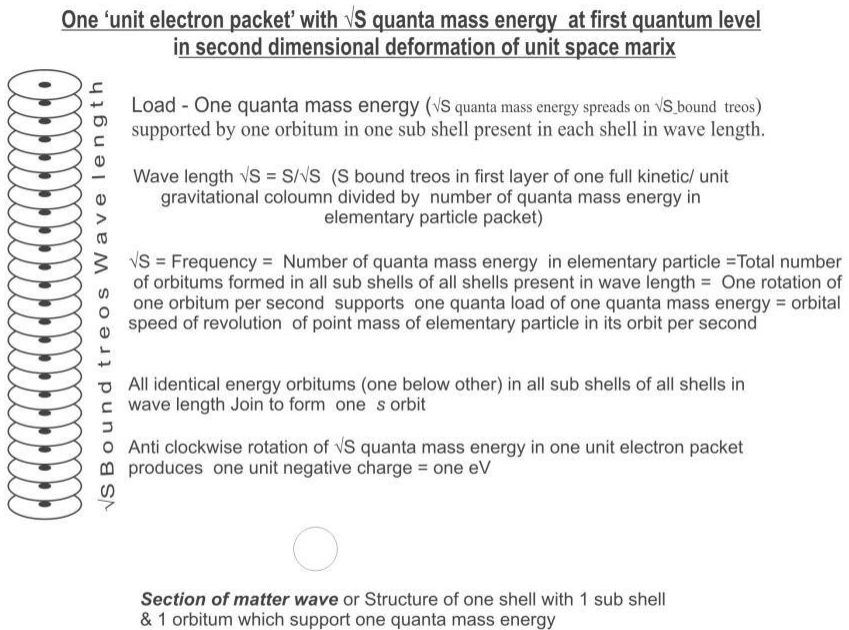

diagramatic representation

Figure 13: Coloumn geometry in Second dimension at first quantum level

packet) on \sqrt{S} apex bound trees in its Reduced Compton wave length (S bound trees/ \sqrt{S} quantum mass energy in packet). The load is one quantum at each of \sqrt{S} apex bound trees, as it evenly distributes its mass energy in vertically placed packet along its \sqrt{S} RC wave length.

\sqrt{S} quanta, mass energy in one unit electron deforms \sqrt{S} bound tree layers in each shell (kinetic column) at first quantum level, and thus \sqrt{S} is frequency of this wave. (Fig. 14)

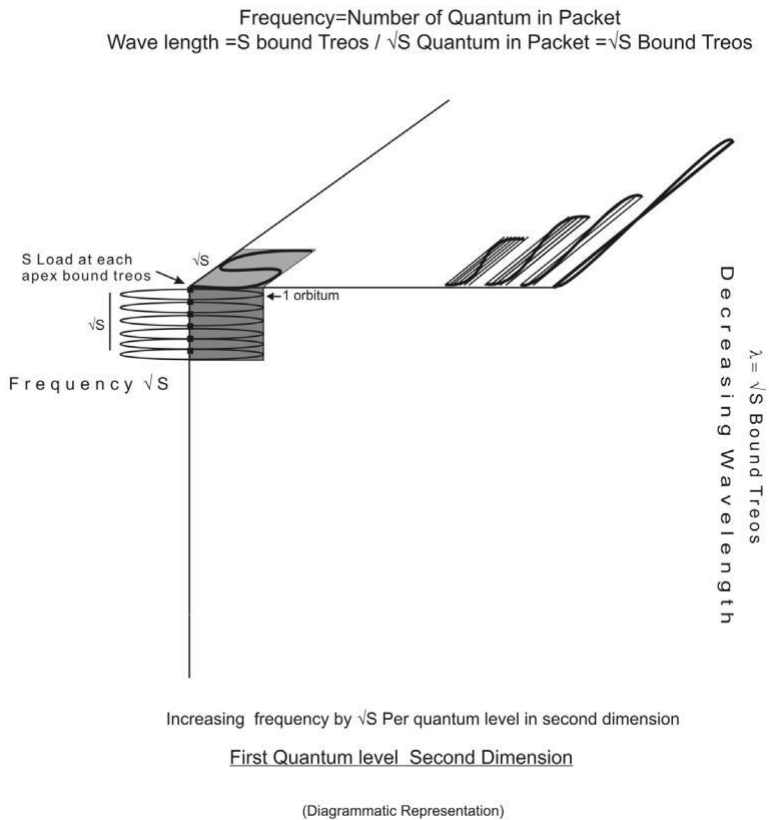

Figure 14: Column geometry in Second dimension at first quantum level (**side view**): one orbitum forms from S kinetons in a square of \sqrt{S} bound trees and for \sqrt{S} orbitums in wave length, \sqrt{S} such squares will deform from one corner cube of \sqrt{S} bound trees.

This, S free treos (i.e. one quantum) load is supported by S kinetons of one orbitum which is present at each apex bound treo (in one sub shell of shell) along RC wave length of one–unit electron.

One deformed square has \sqrt{S} bound treos in its one side and also in its diagonal and has area of S bound treos ($\sqrt{S} \times \sqrt{S}$ bound treos), which get converted into S kinetons to form one orbitum.

This one square is from one corner of one sheath while \sqrt{S} squares of \sqrt{S} sheets of unit space matrix one below other deforms to form \sqrt{S} orbitums.

One orbitum which form at each of \sqrt{S} apex bound treos in vertical wave length, rotates once in one second (in its sub shell of one shell), and all orbitums one below other form one orbit named as s orbit. (Fig. 15)

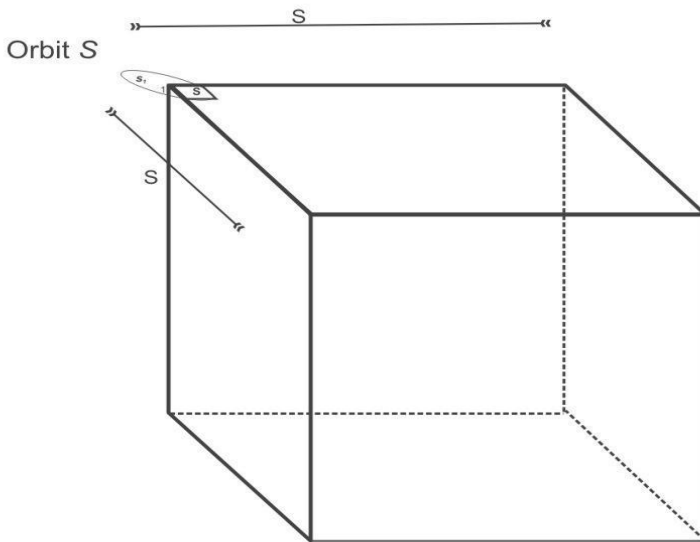

Formation of 1 S Orbit by Union of \sqrt{S} Orbitums

Figure 15: Coloumn geometry in Second dimension at first quantum level

All these squares forming all orbitums are from \sqrt{S} sheets, thus total deformation is of *one corner cube having all its side of \sqrt{S} bound treos* (Fig. 14).

1 Second Quantum level in deformation of second dimension (addition of new \sqrt{S} bound treo layers diagonally, along with 3 new small squares of second row)

The two-unit Electron packet is of $2 \times \sqrt{S}$ quanta mass energy or $2 (\sqrt{S} \times S)$ free treos. And according to formula $\sqrt{S}/2$ bound treo is its RC wave length. (Fig. 16)

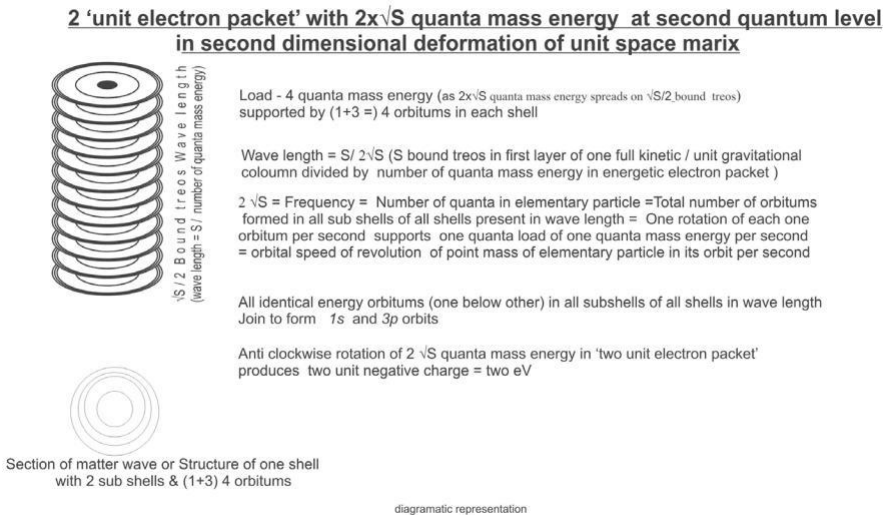

Figure 16: Coloumn geometry in Second dimension at second quantum level

1 square in first row (of \sqrt{S} bound treo layers) forms S kinetons and 3 squares in second row (of \sqrt{S} bound treos layers, which increases diagonally),

kinetic coloumn adds $3S$ kinetons from one sheet, thus form total $1+3$ orbitums in two sub shells (from two row) of each shell at each of $\sqrt{S}/2$ apex

bound tree in wave length and thus vertically placed $\sqrt{S}/2$ more sheets of one unit space matrix are involved just below the deformation of first quantum level. (Fig.17, Fig. 18)

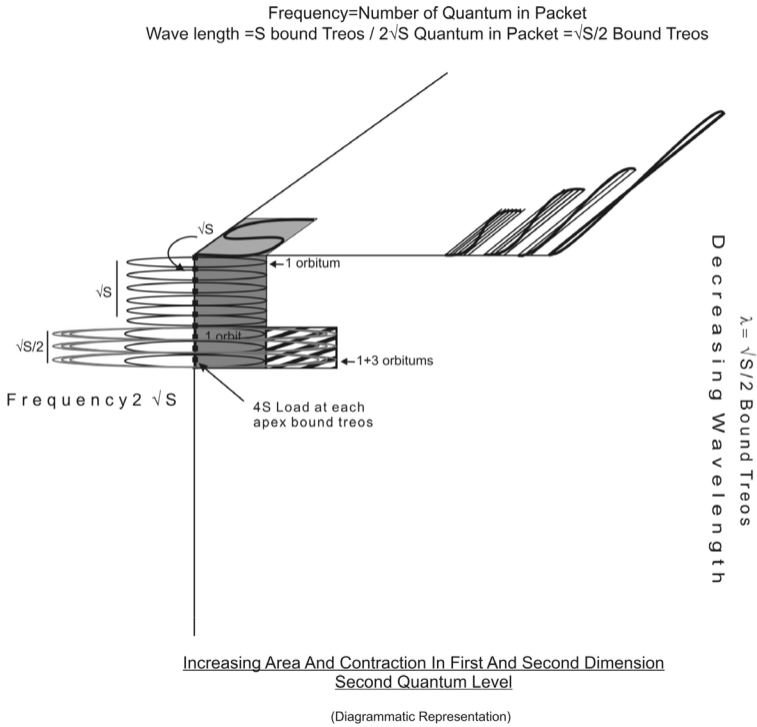

Figure 17 : Coloumn geometry in Second dimension at second quantum level (**side view**) : one orbitum forms from S kinetons in a square of \sqrt{S} bound treos and for additional 3 orbitums in second sub shell, 3 such squares from second row deforms. For all orbitums in wave length such 1+3 squares deform are from two rows, in all $\sqrt{S}/3$ sheets which deform below first quantum level.

Thus two–unit electron mass energy packet exert load of 4 quanta i.e. 2^2 quanta (as double mass energy spread in half wave length) at each apex bound tree, which is supported by 1+3 orbitums in two sub shells of each shell.

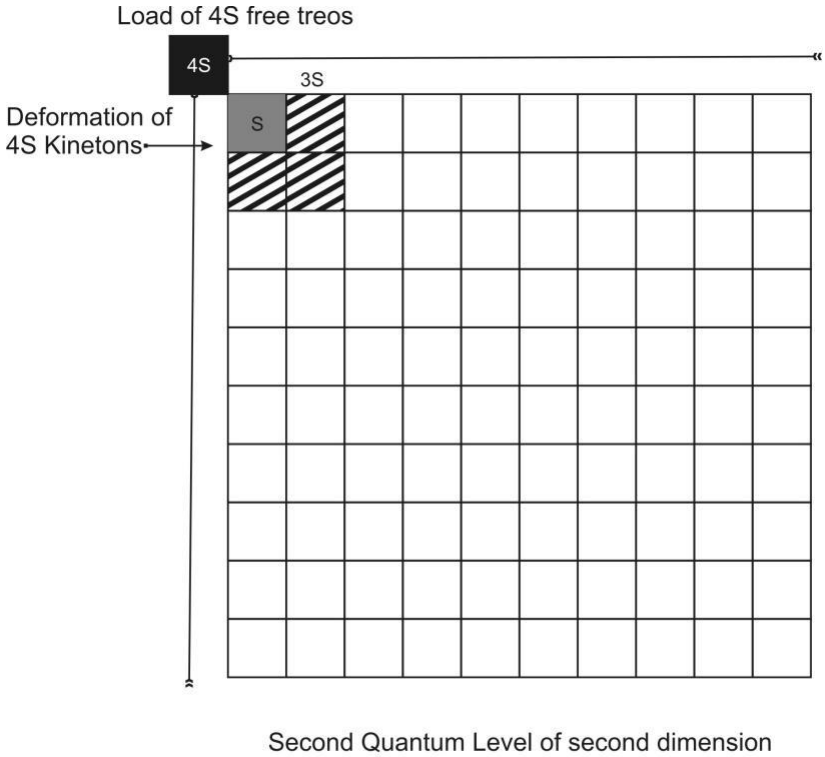
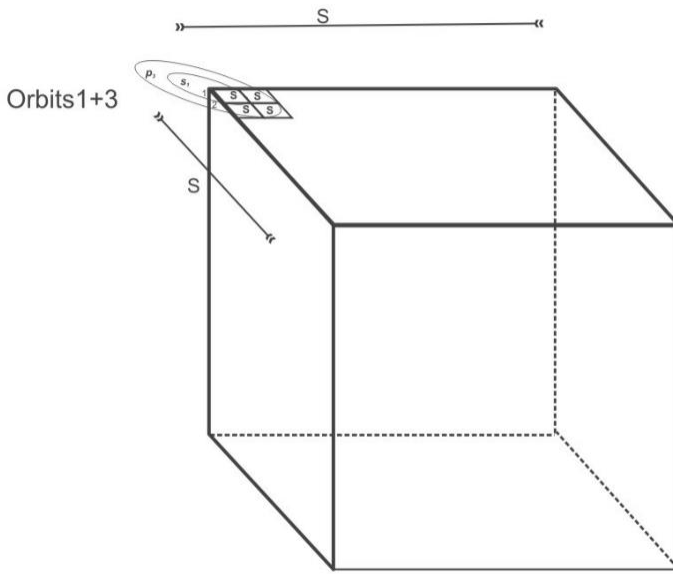

Figure 18: Coloumn geometry in Second dimension at second quantum level (**Top view**)
 As, $2 \times \sqrt{S}$ quanta is mass energy in this two-unit electron packet and in each shell of radius $2 \times \sqrt{S}$ bound tree layers have 2 sub shells, and $1S + 3 S$ kinetons from $1+3$ squares in two rows, forms $1 + 3$ orbitums and thus $2 \times \sqrt{S}$ is frequency of this wave.

All identical energy orbitums one below other together form 1 *s* orbit and 3 *p* orbits. (Fig.19)



Formation of 1 S Orbit by Union of \sqrt{S} Orbitals
and 3 P Orbits by Union of $\sqrt{S/2}$ Orbitals

Figure 19: Column geometry in Second dimension at second quantum level: 1 orbitum from one square and 3 orbitums from 3 squares form one shell. These identical energy orbitums jointly placed, one over other in all shells in wave length, form 1 s and 3 p orbits.

2 Third Quantum level in deformation of second Dimension (addition of new \sqrt{S} bound tree layers and 5 more squares of third row)

The three-unit electron packet is of $3 \times \sqrt{S}$ quanta mass energy or $3 (\sqrt{S} \times S$ free trees). And according to formula S bound tree $/3 \times \sqrt{S}$ quanta mass energy in packet and thus $\sqrt{S/3}$ apex bound tree is its R C wave length.

This packet spreads in $\sqrt{S/3}$ apex bound tree wave length and exert 9 quanta i.e. 3^2 quanta load on each apex bound tree.

3 'unit electron packet' with $3\sqrt{3}$ quanta mass energy at third quantum level in second dimensional deformation of unit space matrix in depth

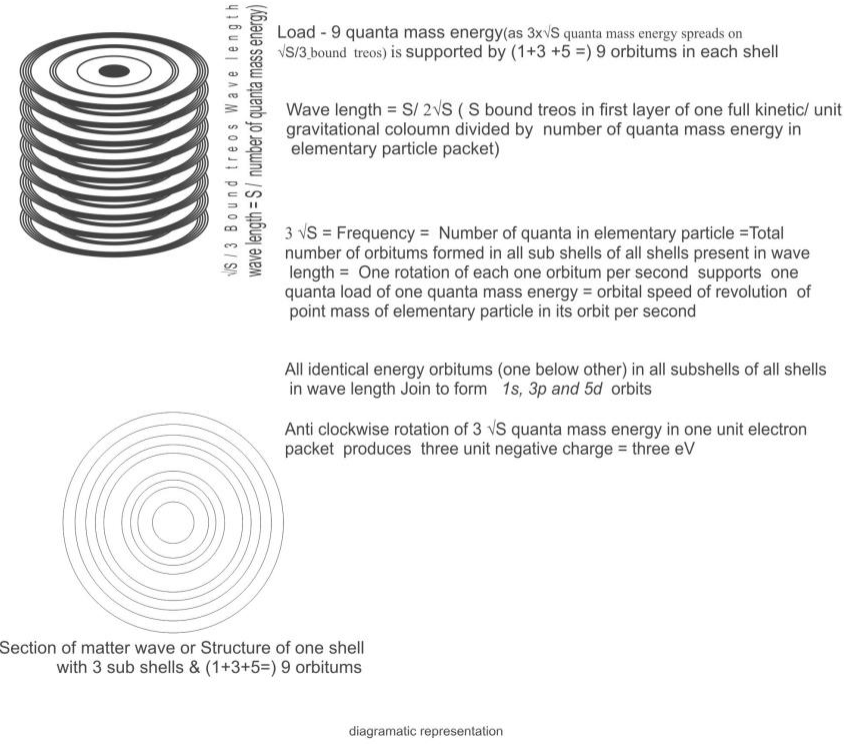

Figure 20: Column geometry in Second dimension at third quantum level

With increasing mass energy and decreasing wave length 'Three-unit electron mass energy packet' exert load of 9 quanta at each apex bound tree, which is supported by 1+3+5 orbitums in three sub shells of each shell. All identical energy orbitums one below other in wave length form 1s, 3p and 5d orbits.

While $3 \times \sqrt{S}$ quanta is mass energy of this three-unit electron packet and $3 \times \sqrt{S}$ bound tree layers are deformed from three rows and thus $3 \times \sqrt{S}$ is frequency of this wave.

$1 + 3 + 5$ squares are in these first, second and third rows, deforms 1S kineton area + 3 S kineton area + 5 S kineton area = 9 S kinetons area in each shell (Fig. 22).

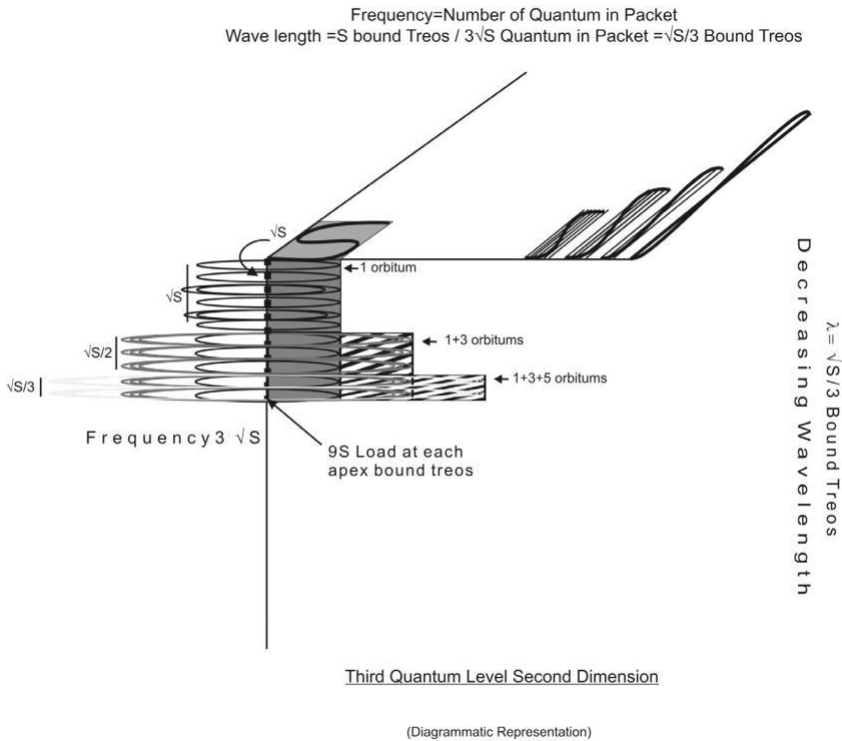
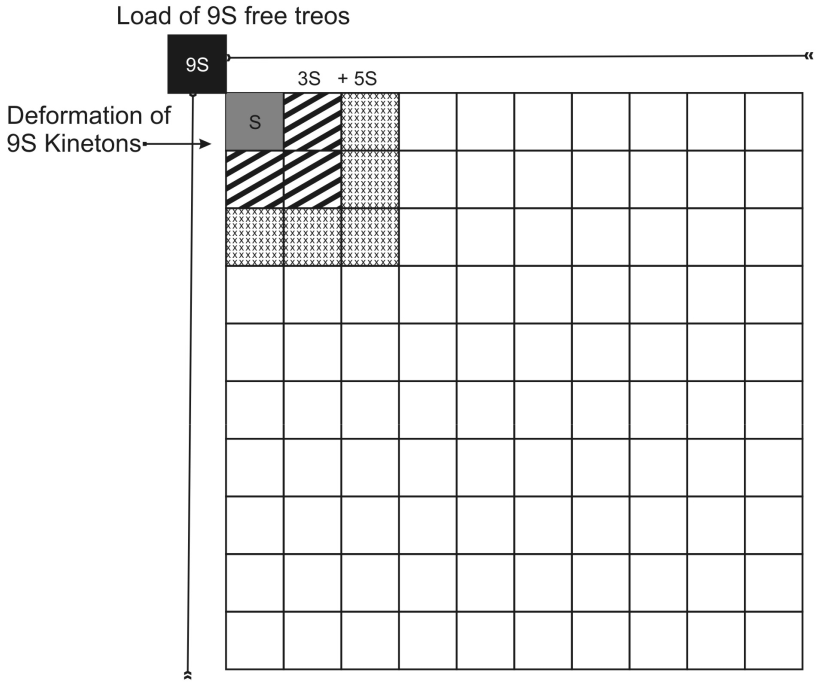

Figure 21: Column geometry in Second dimension at third quantum level (**side view**):

1 orbitum forms from S kinetons in 1 square of first row, 3 orbitums from 3 squares in second row, and 5 orbitums from 5 squares in third row deforms. For all orbitums in wave length such $1+3+5$ squares deform in three rows, in all $\sqrt{S}/3$ sheets (which deform below second quantum level).

1 square in first row (S kinetons), 3 squares in second row (3S kinetons), and 5 squares in third row (5S kinetons) are deformed in each of $\sqrt{S}/3$ sheets of



Third Quantum Level of second dimension

Figure 22: Column geometry in Second dimension at third quantum level (**Top view**)

unit space matrix just below the deformation of second quantum level. (Fig.21 Fig.22)

At Third quantum level which form just below second quantum level of second dimension, each shell has $(S + 3S + 5S)$ kinetons from $1 + 3 + 5$ squares in three rows. S kinetons are in one square ($= \sqrt{S} \times \sqrt{S}$ kinetons) of first row, $3S$ kineton in three squares of second row and $5S$ kinetons in 5 squares of third row which form $(1+3+5)$ orbitums) in three sub shells in each shell present at $\sqrt{S}/3$ apex bound trees in vertical wave length.

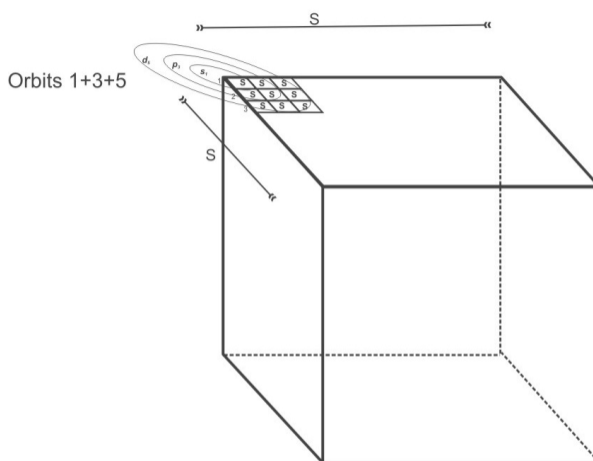

Formation of 1 S Orbit by Union of \sqrt{S} Orbitums.
3 p Orbits by Union of $\sqrt{S/2}$ Orbitums
5 d Orbits by Union of $\sqrt{S/3}$ Orbitums

Figure 23: Column geometry in Second dimension at third quantum level: 1 orbitum from one square in first row and 3 orbitums from 3 squares in second row, 5 orbitums from 5 squares in third row are formed. These identical energy orbitums jointly placed, one over other in all shells in wave length, form 1 *s*, 3 *p*, 5 *d* orbitms.

Below the deformation at first and second quantum level; it deforms $\sqrt{S/3}$ sheets in corner of unit space matrix which gets involved to form $\sqrt{S/3}$ shells. (Fig. 21)

As it forms 1, 3 and 5 orbitums in three sub shells in each shell present at each apex bound treos in wave length. All identical energy orbitums one below other in wave length together form 1 *s* orbit and 3 *p* orbitms and 5 *d* orbitms. (Fig. 23)

3 Fourth Quantum level in deformation of second dimension (addition of new \sqrt{S} bound treeo layers and 7 squares)

4 'unit electron packet' with $4\sqrt{S}$ quanta mass energy at fourth quantum level

Load - 16 quanta mass energy(as $4 \times \sqrt{S}$ quanta mass energy spreads on $\sqrt{S}/4$ bound trees) supported by $(1+3+5+9=)$ 16 orbitums in each shell



Wave length = $S/4\sqrt{S}$ (S bound trees in first layer of one full kinetic / unit gravitational column divided by number of quanta mass energy in elementary particle packet)

$4\sqrt{S}$ = Frequency = Number of quanta in elementary particle
 = Total number of orbitums formed in all sub shells of all shells present in wave length = One rotation of each one orbitum per second supports one quanta load of one quanta mass energy = orbital speed of revolution of point mass of elementary particle in its orbit per second

All identical energy orbitums (one below other) in all subshells of all shells in wave length Join to form *1s, 3p, 5d and 7f* orbits

Anti clockwise rotation of $4\sqrt{S}$ quanta mass energy in one unit electron packet produces 4 unit negative charge = four eV

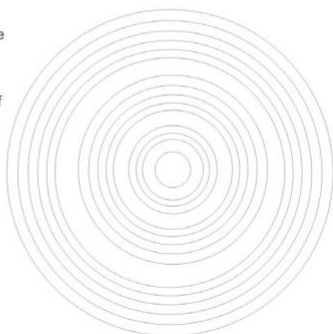

Section of matter wave or Structure of one shell with 4 sub shells & $(1+3+5+7) = 16$ orbitums

diagrammatic representation

Figure 24: Column geometry in Second dimension at fourth quantum level.

The Four-unit Electron packet is of $4 \times \sqrt{S}$ quanta mass energy or $4(\sqrt{S} \times S$ free trees). And according to formula S bound tree/ $4\sqrt{S}$ quanta mass energy in packet and $\sqrt{S}/4$ apex bound tree is its vertical R C wave length. (Fig. 24 and 25)

With increasing mass energy and decreasing wave length 'Four-unit electron mass energy packet' exert load of 16 quanta at each apex bound tree along its $\sqrt{S}/4$ wave length. 16 quanta i.e. 4^2 quanta load is supported by each shell present at all apex bound tree in wave length.

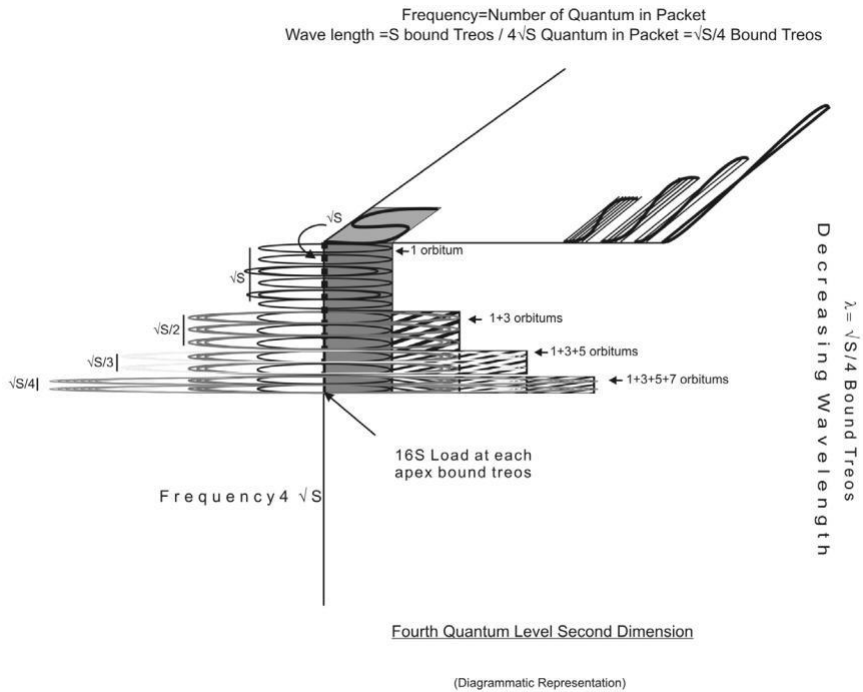

Figure 25: Coloumn geometry in Second dimension at fourth quantum level (**side view**)

1 orbitum forms from S kinetons in 1 square of first row, 3 orbitums from 3 squares in second row, 5 orbitums from 5 squares in third row and 7 orbitums from 7 squares in third row forms. For all orbitums in each shell, such 1 + 3 + 5 + 7 squares in four rows, are deformed in all $\sqrt{S}/4$ sheets (which deform below third quantum level).

Each shell has 4 sub shells in breadth which comes from 4 rows. Each row is of \sqrt{S} bound treo layers which form one sub shell. They have 1 + 3 + 5 + 7 squares in four rows, and with 1S kineton area, + 3 S kineton area, + 5 S kineton area and + 7 S kineton area = 16 S kinetons area is of each shell in

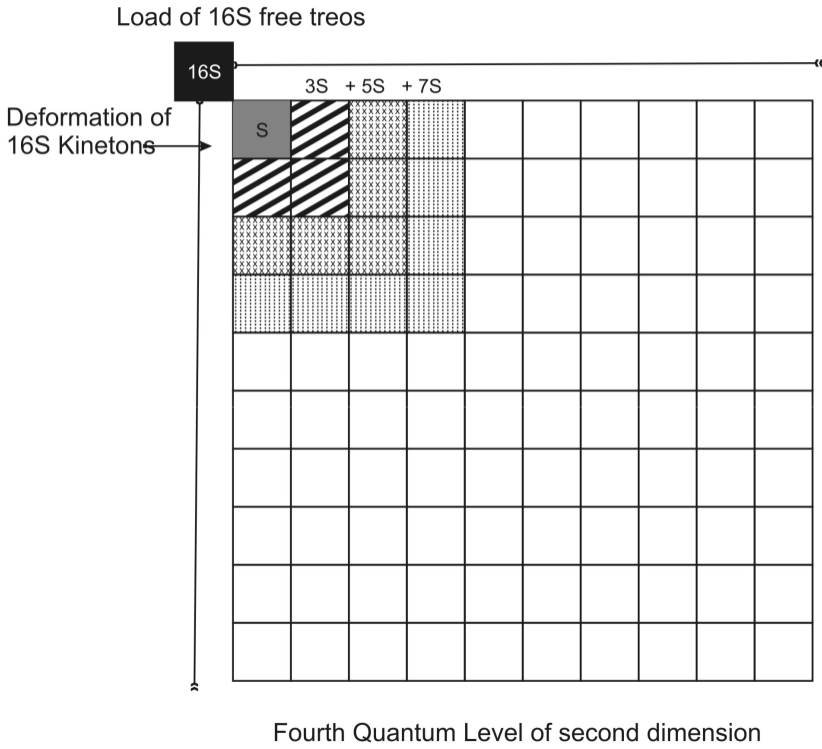

Figure 26: Coloumn geometry in Second dimension at fourth quantum level (**Top view**)

which it forms $1 + 3 + 5 + 7 = 16$ orbitums. Each orbitum of S kinteton supports S free treo (one quantum mass energy) of packet by its one rotation in one second. (Fig 24).

Thus $4 \times \sqrt{S}$ quanta is mass energy of packet and $4 \times \sqrt{S}$ bound treo layers are deformed in four rows thus $4 \times \sqrt{S}$ is frequency of this wave.

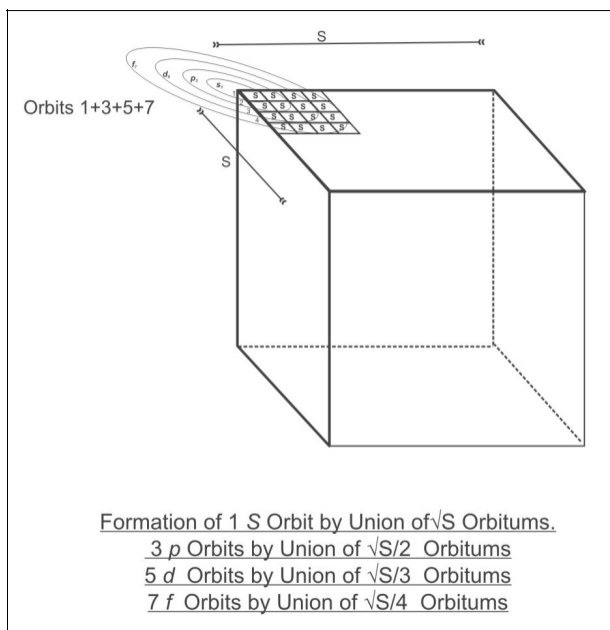

Figure 27: Column geometry in Second dimension at fourth quantum level:

1 orbitum from one square in first row, 3 orbitums from 3 squares in second row, 5 orbitums from 5 squares in third row and 7 orbitums from 7 squares in fourth row are formed. These identical energy orbitums jointly placed, one over other in all shells in wave length, form 1s, 3 p, 5 d, 7 f orbitals.

1 square in first row (S kinetons), 3 squares in second row ($3S$ kinetons), 5 squares in third row ($5S$ kinetons) and 7 squares from fourth row ($7S$ kinetons) are deformed in each of $\sqrt{S/4}$ sheets of unit space matrix just below the deformation produced at third quantum level. (Fig.25 and 26)

Thus, one orbitum of S kinton comes from one square in first row, 3 S kinetons and 3 orbitums comes from three squares in second row, 5 S kinetons and 5 orbitums from 5 squares in third row and 7 S kinetons and 7 orbitums from 7 squares in fourth row, are in 4 sub shells of each shell present at all $\sqrt{S/4}$ apex bound trees in wave length.

All identical energy (1 + 3 + 5 + 7) orbitums one below other jointly forms 1s, 3p, 5d and 7f orbits (Fig.27).

4 Last Or \sqrt{S} Quantum Level in Deformation of Second Dimension

The \sqrt{S} units of unit electron mass energy packet accumulates as, $\sqrt{S} \times \sqrt{S}$ quanta mass energy; or S quanta mass energy (or S^2 free treos), which are in one unit mass and it is also one Planck's mass (2.16×10^{-8} kg).

According to formula S bound treo/S quanta mass energy in packet; thus, only one apex bound treo is RC wave length of one unit mass.

But as S quanta is mass energy in this one-unit mass. Now with the involvement of \sqrt{S} rows diagonally and each of \sqrt{S} bound treo layers and up to \sqrt{S} quantum levels, it is total S bound treo layers (= \sqrt{S} quantum levels \times \sqrt{S} bound treo layers which increase at each quantum level) are deformed to form this shell and thus S is frequency of this wave.

1 square in first row (S kinetons), 3 squares in second row (3S kinetons), 5 squares in third row (5S kinetons) and 7 squares from fourth row (7S kinetons) and so on $2n - 1$ squares in any n^{th} rowand then finally $2\sqrt{S} - 1$ squares are added in last \sqrt{S}^{th} row and thus it involve one full last sheet of unit space matrix (in depth), at last quantum level. This last one sheet has S quanta or S^2 kinetons, in total S number of small squares which are present in all \sqrt{S} rows (Fig. 28)

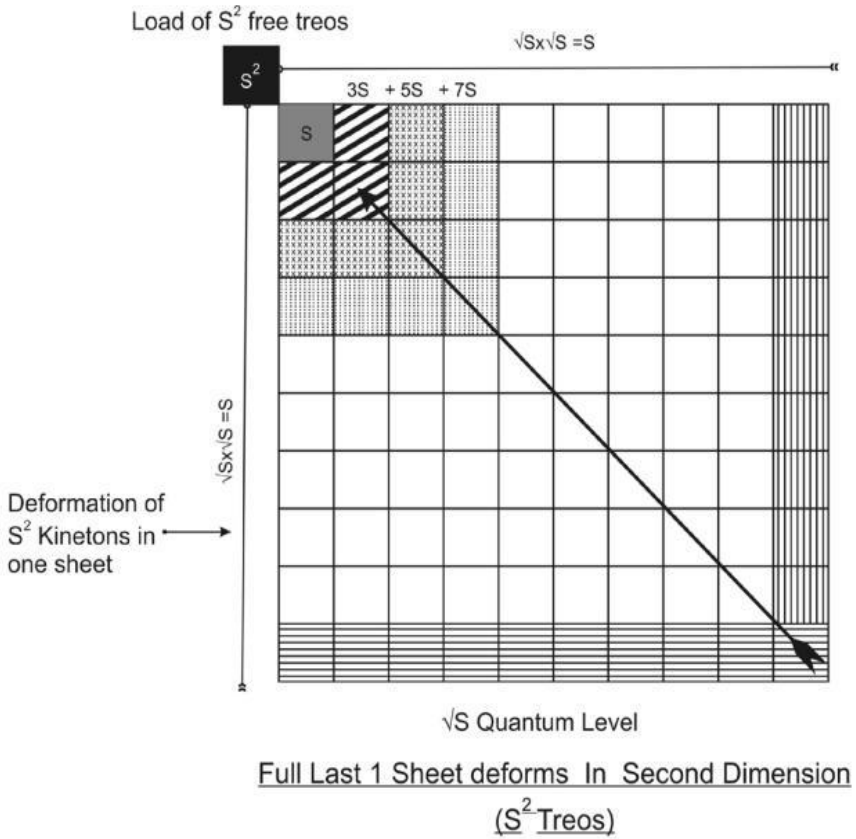
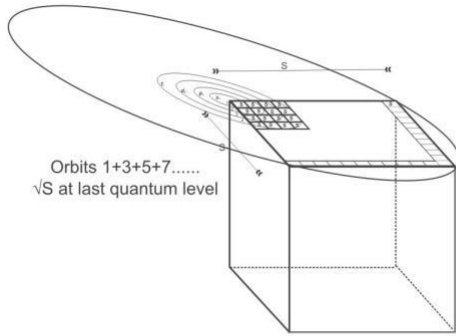

Figure 28: Column geometry in Second dimension at last \sqrt{S} quantum level (**Top view**): 1 square + 3 squares + 5 squares + 7 squares and so on ... $2n - 1$ squares in any n^{th} rowand then finally $2\sqrt{S} - 1$ squares are added in last \sqrt{S}^{th} row; thus it finally involve one full last sheet of unit space matrix in depth, at last quantum level, with its one wave length.

From \sqrt{S} rows in last full sheet, total $\sqrt{S} \times \sqrt{S} = S$ squares are deformed, which have total S quanta kinetons (S orbitum form each of one quanta) which form one full matter wave in last layer to support one-unit mass of S quanta mass energy or S^2 free treos.

Thus, a matter wave which form at last quantum level is of 1 bound treo RC wave length i.e. at only one apex bound treo, or at the unit gravitational center (at one graviton) and it supports one-unit mass.



Formation of 1 S Orbit by Union of \sqrt{S} Orbitals.
3 p Orbits by Union of $\sqrt{S}/2$ Orbitals
5 d Orbits by Union of $\sqrt{S}/3$ Orbitals
7 f Orbits by Union of $\sqrt{S}/4$ Orbitals
 $2\sqrt{S}-1$ orbits at last quantum level each of 1 orbitum

Figure 29: Column geometry in Second dimension at last \sqrt{S} quantum level:
 S orbitums in last one sheet and total S orbitums at all quantum levels together in one graviton column, support one-unit mass of S^2 free treos.

The last matter wave is formed by one revolving shell, which have \sqrt{S} sub shells (in last sub shell it adds $2\sqrt{S}-1$ orbitums) and total S orbitums or S orbits, with total involvement of S bound treo layers in length and S bound treo layers in breadth in last sheet in total full deformation of second dimension (Fig. 29).

C. Deformation And Counter Deformation In Second Dimension.

To visualize the step by step increasing total deformation of second dimension, from 1st quantum level with deformation of just 1 square in \sqrt{S} sheaths, to last quantum level with deformation of all S number of squares in one last sheet, we will draw this deformation in a cube of one unit space matrix as shown in Figure 30 (with its 8 corners A, B, C, D at top and E, F, G, H corners at its bottom, in which E corner is below A corner).

The deformation starts from corner A and gradually increases in steps to end after deforming one last (square) sheet with its corners E, F, G, H and thus total deformed area (not drawn in steps) can be marked by joining lines from corner A to E, F, G, H.

The identical Counter-deformation starts from diagonally opposite corner C and then gradually increasing in steps, this also ends at this last squared sheet (E, F, G, H corners) and this total area deformed can be marked by joining lines from C to E, F, G, H. Now we will notice a point O appears, a meeting point of line AG with line CE, and pyramid shaped area below this point O appears with its base at E, F, G, H, **in which both deformation and counter deformation vortexes overlaps**, and while rotating in two opposite directions they forms two vortexes.

(Vortex- is a area where the flow spins around an axis line which can be straight or curved shape. They can complexly move, stretch, twist and interact with the surroundings.)

The four Quantum levels n_1, n_2, n_3, n_4 of deformation and same quantum levels are from counter deformation n'_1, n'_2, n'_3, n'_4 are marked as Four paired circles (total 8 circles) near apex of this pyramid, drawn just below point O.

With increasing number of protons and increasing atomic number (Z), and the increasing nuclei in atom with increasing atomic weight (A) it gradually increase the size of nucleus, and also forms 1st, 2nd, 3rd and 4th quantum levels in both vortexes in this field.

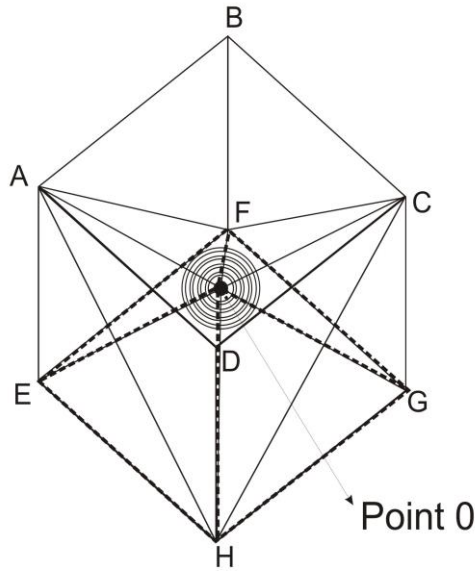

Figure 30: Deformation of cube of *one unit space matrix* in second dimension starts from point A, while counter deformation starts from point C, but finally both deforms square EFGH. Thus a pyramid shaped area with its peak at point O and its base on EFGH will be overlapped by two deformations. Near apex of pyramid thus formed below point O four quantum levels of deformation and counter deformation are marked as 8 circles, where atoms of all known 118 elements condenses.

Thus increasing deformation with increasing load (protons and nucleons) at four quantum levels will form four shells from each vortex.

1st quantum level *shell* will have one sub shell named as *s*; at 2nd quantum level, it will have two sub shells (*s* and *p*); at 3rd quantum level three sub shells (*s*, *p*, *d*); and at 4th quantum level it will have 4 sub shells (*s*, *p*, *d*, *f*); and similarly four shells will contributed from counter-deformation vortex will have sub shells in the same pattern at 1st, 2nd, 3rd and 4th quantum levels.

These 8 quantum levels will form near point O, at centre of 4 paired circles drawn in Figure. The nucleus of this increasing deformation will enlarge

(sink) along a plumb line drawn from Point O, to 'the meeting point of two imaginary lines AG and HF'.

Every orbit formed can have two opposite spin electrons; Spin Up is clockwise, while Spin down is counter clock wise spin of electron.

In First shell there is one first sub shell s there is 1 orbit which can have 2 electrons (1+1); this is K atomic energy level.

In second shell there are two s, p sub shells will have 1 and 3 orbits; s with sub shell with one orbit can have two (1+1) electrons and p sub shell with 3 orbits can have six electrons (3+3); thus total 8 electrons (2+6) are in second shell; These shells are at L atomic energy level.

In third shell there are three s, p, d sub shells will have 1, 3 and 5 orbits; where s has two (1+1) electrons and p has six electrons (3+3), while d sub shell has 10 (5+5) electrons totaling 18 electrons (2+6 +10) in these shell; These shells are at M atomic energy level.

Fourth shell will have four sub shells s, p, d, f with 1, 3, 5 and 7 orbits; ; where s has two (1+1) electrons, p has six electrons (3+3), d sub shell has 10 (5+5) electrons and sub shell f will have 7 orbits with 14 (7+7) electrons, and will total 32 electrons (2+6 +10 +14); These shells are at N atomic energy level.

With each addition of Proton and along with increasing Z number, equal number of electrons will fill the empty orbits formed in both deformation and counter deformation, to form all 118 known elements grouped in periodic table.

The filling of electrons with +spin and -spin in each orbit, obey Pauli's principal, Hund's rule and Aufbau principal.

Seven periods of periodic table, incorporate all 118 elements which are formed in 8 shells at these 8 quantum levels, where first period of periodic table have first two elements which are formed at n_1 and n'_1 two atomic quantum levels.

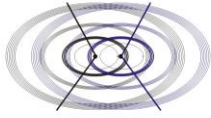

Atomic configurations form at junction of two magnetic vortices in deformation of second dimension

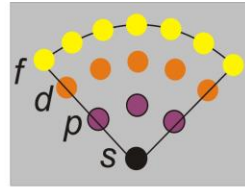

s, p, d, f atomic sub shells at fourth atomic quantum level

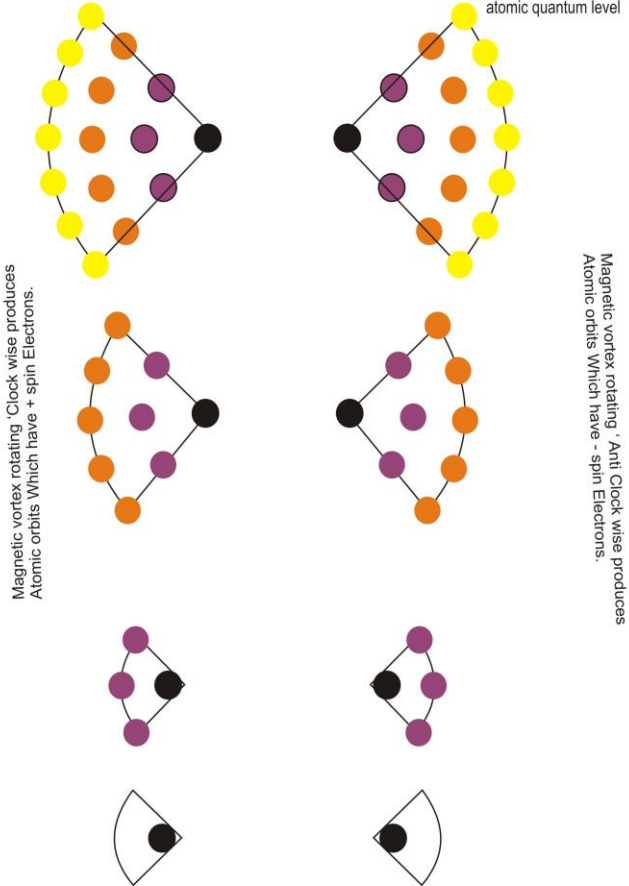

Magnetic vortex rotating 'Clock wise produces Atomic orbits Which have + spin Electrons.

Magnetic vortex rotating 'Anti Clock wise produces Atomic orbits Which have - spin Electrons.

Two magnetic Vortices rotating in 'clock wise' and 'anti clock wise' rotations form Atomic orbits with + Spin and - spin Electrons which totals 2,8,18,32 at four 'atomic quantum levels'.

Figure 31 Orbits at four quantum level with one by one increasing s, p, d, f sub shells.

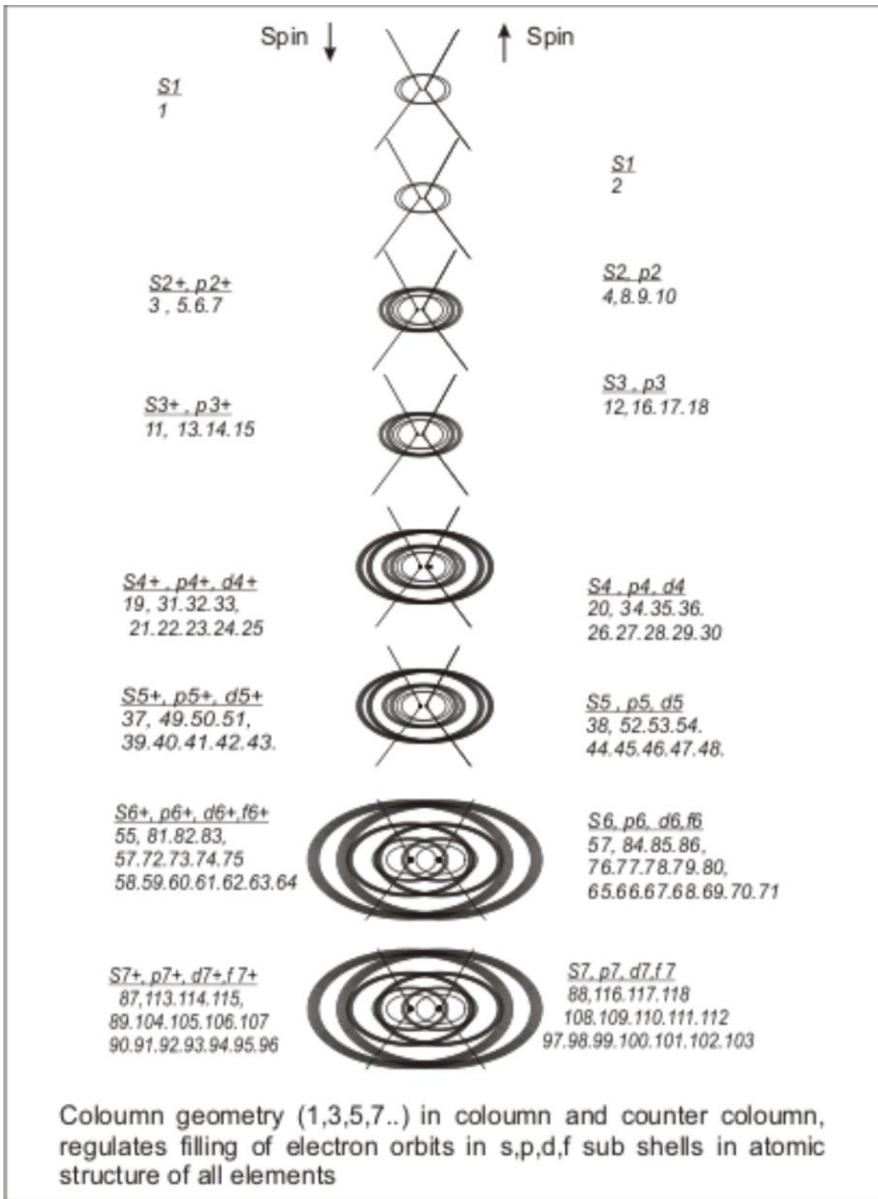

Figure 32. At four atomic quantum level with increasing number of s, p, d, f sub shells, all orbits are filled with electrons to form all 118 elements of periodic table.

With increase of one proton (or nucleon) the deformation of second dimension will shift at its matching quantum level. But atomic quantum

levels forms only at quantum levels, where circumference of Electron orbit is equal to the integral numbers of its wave length,

$$J = mvr = nh/2\pi$$

Radius of permitted orbits is proportional to square of quantum number (n), in integrals of 1, 2, 3 and then $r = n^2$ (and r can be 1, 4, 9 and 16 times etc) Bhor orbits are at 0.53 A^0 ; $4 \times 0.53 \text{ A}^0$; $9 \times 0.53 \text{ A}^0$ and $16 \times 0.53 \text{ A}^0$ (Where $\text{A}^0 = 10 \times 10^{-10} \text{ Cm}$)

1/2 Spin of particle (of nucleons) means that after two full rotations it will return to its original orientation, while 2 spin of graviton means it will require only half rotation to regain its orientation (like card of a queen or king in a pack of playing cards). Addition of electrons with opposite spin means up Spin and down Spin electron, with clockwise and anticlockwise direction of there rotations.

D. Deformation in Three Dimensions of

Length, Breadth and Dept (To support from one unit mass to \sqrt{S} unit masses body)

Unit mass is the maximum ‘load’ (approximately equal to one flea egg), which is supported at its one–unit gravitational center, at one graviton placed at one bound tree of space matrix. But then how bigger masses like cosmic bodies and galaxies are supported by space matrix?

Maximum load of \sqrt{S} unit masses body (of 10^{13} kg or one billion metric ton)*, which exert the ‘load’ of S unit masses (square of number of unit masses in body) at its gravitational center, is supported by equal number of S gravitons. All these S gravitons are placed according to column geometry ($2n-1$ in any n^{th} layer and n^2 in coloumn), in one ‘kinetic coloumn of third dimension’ of \sqrt{S} spiral graviton layers, named as one ‘electron black hole’ (named as it is of size of one unit electron).

*(For even bigger cosmic bodies of more than \sqrt{S} unit masses the deformation involves fourth dimension of time and then around its unit gravitational center one gravitational sphere forms

to support the load of square number of unit masses in body by equal number of gravitons in this gravitational sphere, with the deformation of all four dimensions of Space-Time.)

Theme of Deformation in third dimension—In universe, @ one free tree is supported by one kinton and thus each unit mass (S^2 free trees) is supported at one graviton by its one graviton column made up of S^2 kintons.

But from one-unit mass to \sqrt{S} unit mass bodies which exerts square number of unit masses load at its gravitational centre, is supported by square number of one to S gravitons in increasing number of spiral layers (from one to \sqrt{S} spiral layers) at 1 to \sqrt{S} quantum levels, in formation of one electron black hole; which form one cyclonic wave in third dimension.

For the biggest \sqrt{S} unit mass body supported in third dimension (i.e. of approx. 10^{13} Kg; one billion metric ton), one kinetic column of electron black hole of \sqrt{S} spiral concentric layers directs a combined kinetic pressure (of all S gravitons present in this kinetic column) towards its apex at the gravitational center of body, to support its S unit mass load. (As per column geometry, $2n-1$ gravitons are present in any n^{th} spiral layer of this one electron black hole while n^2 gravitons are in n layered kinetic column)

The Electron black hole is one full kinetic column of third dimension having \sqrt{S} spiral concentric layers (which get compacted to the size of one electron of 10^{-13} meter), and has total S gravitons formed by deformation of S^3 bound trees (all pages of one book) in complete three-dimensional contraction of one cube of one-unit space matrix.

The gravitational field of this electron black hole will form by union of graviton columns of $2\sqrt{S}-1$ gravitons present in outermost layer of this electron black hole.

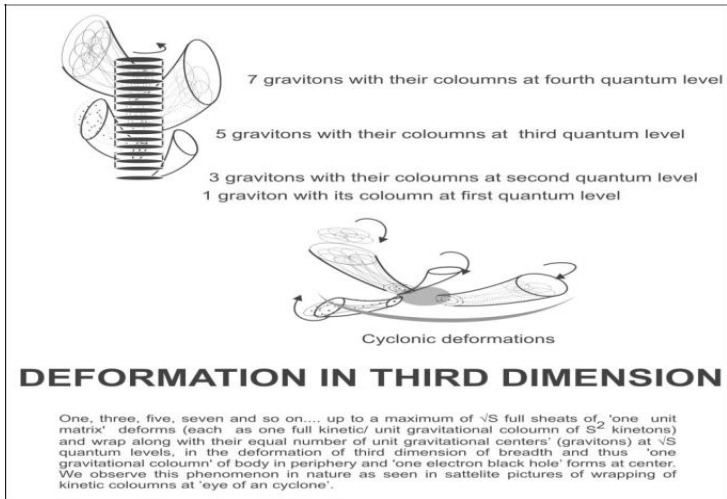

Figure 33: Column geometry in complete deformation of Third dimension

We can actually visualize such bigger deformations of third dimension; in satellite picture of 'eye of a cyclone' along with circulating and winding layers of graviton columns; which produce havoc in cyclone effected areas. (Fig.33 and fig.34)

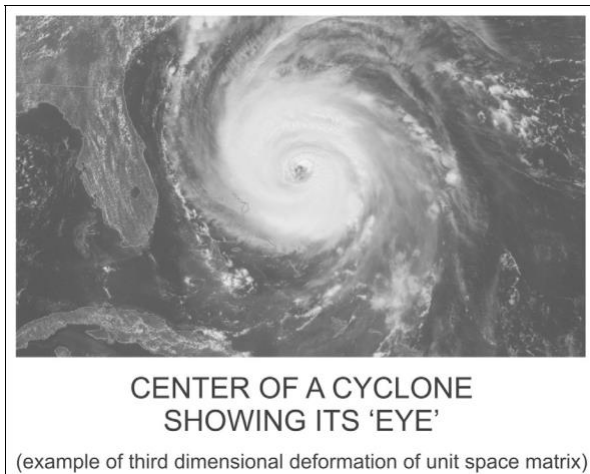

Figure 34: Column geometry in Third dimension as seen in nature

(a) First Quantum level in deformation of third dimension

One deformed last full sheet (last page of our book for understanding) of unit space matrix in second dimension, with its S^2 kinetons converted as one graviton column, wraps at first quantum level of third dimension and it support one–unit mass at one graviton in 1st spiral layer of electron black hole. (fig. 35a)

(b) Second Quantum level in deformation of third dimension

Three deformed full sheets (3 pages above last page) of unit space matrix just above first quantum level each with S^2 kinetons (as one graviton column), wraps at second quantum level to support two–unit masses in a body, with its exerted load of 4 unit masses, {in square of unit masses i.e. of $(2)^2$ unit masses at its gravitational center}, by 4 gravitons = 1 + 3 gravitons, in 1st and 2nd spiral layer, where 1 + 3 full sheets (each forming its one graviton columns) of unit space matrix are wrapped, while making an two layered kinetic column of electron black hole. (Fig. 35 b)

(c) Third Quantum level in deformation of third dimension

Five deformed full sheets; 5 pages, above pages already deformed (1+3 pages) of unit space matrix just above second quantum level, each having S^2 kinetons (and each forming one graviton column) wraps at third quantum level to support three–unit masses in a body with its load of $(3)^2$ unit masses at 9 gravitons = 1 + 3 + 5 gravitons, in 1st, 2nd and 3rd spiral layer of electron black hole (Fig. 35c)

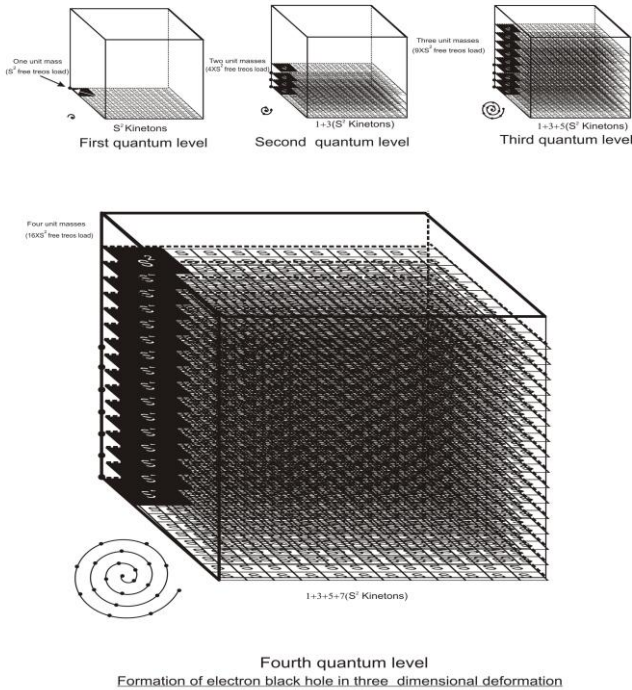

Figure 35: Column geometry in Third dimension at 1st, 2nd, 3rd and 4th quantum level.

(d) Fourth Quantum level in deformation of third dimension

Now at fourth quantum level 7 gravitons and 7 graviton columns, which are from 7 full sheets [7 pages above, pages already deformed (1+3+5 pages)], adds in fourth spiral layer in deformation at fourth quantum level of third dimension, to support four-unit mass in a body with its total load of 16 unit masses which is supported by 16 gravitons = at 1 + 3 + 5 + 7 gravitons in 1st, 2nd, 3rd and 4th spiral layer of electron black hole. (Fig. 35)

With addition of one-unit mass at any n^{th} quantum level, $2n-1$ new graviton with $2n-1$ graviton columns from $2n-1$ sheet wrap to form any n^{th} spiral layer of electron black hole.

(e) Last \sqrt{S} Quantum level in deformation of third dimension

In last spiral layer, $2\sqrt{S}-1$ gravitons and $2\sqrt{S}-1$ graviton columns from $2\sqrt{S}-1$ sheets add in last \sqrt{S}^{th} spiral layer of electron black hole at \sqrt{S} quantum level of third dimension.

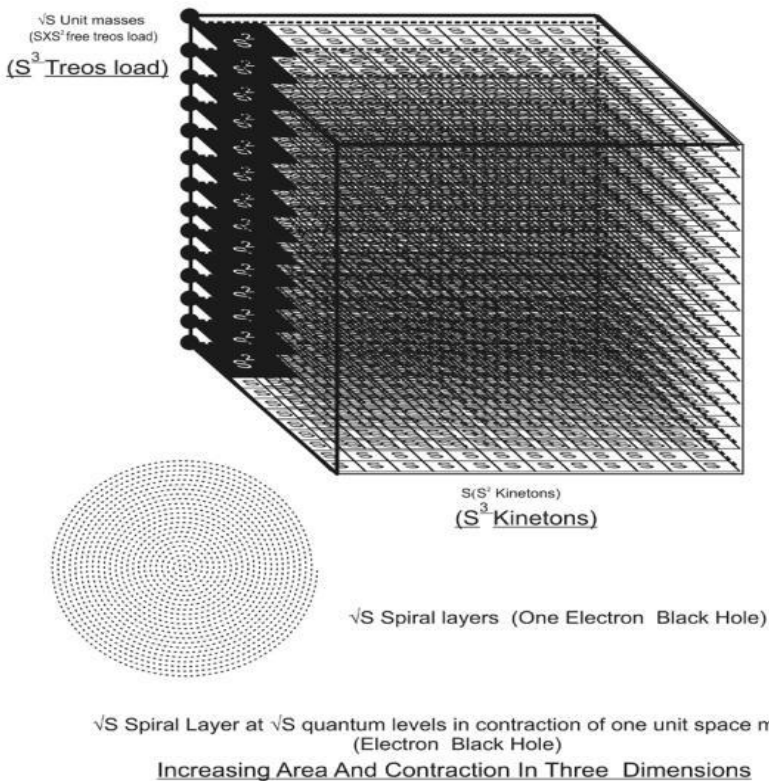

Figure 36: Column geometry in Third dimension at last quantum level.

When $2\sqrt{S} - 1$ gravitons are added in last spiral layer, then this \sqrt{S} layered kinetic column, supports total \sqrt{S} unit masses in a body with its load in square of unit masses i.e. of $(\sqrt{S})^2$ or S unit masses by total S gravitons present at all quantum levels of electron black hole. (Fig. 33)

Thus \sqrt{S} unit masses body (or approximately 10^{13} Kg mass in a body i.e. one billion metric ton) is supported by S gravitons in its \sqrt{S} spiral layers in one \sqrt{S} layered 'electron black hole'

Conclusion

Thus with tree model, theory evolves with following features

1) **Cosmic code** or S number (Planck frequency) decides the value of speed of light, Reduced Planck constant, Planck constant, Gravitational constant, cosmological constant, Hubble constant, Unit photon, Unit Electron, Planck mass, Unit black hole mass, Unit space (unit space matrix), unit time (one second or S vibrations), unit energy or one quanta energy and thus it carves our universe. It also decides S second as life span of universe and S^2 bound trees as radius of undeformed universe.

(2) S Treos is value of reduced Planck constant, it produces unit action and angular momentum of this **one quantum energy** is the value of Planck constant.

(3) Treos as free trees in integral multiple of one quant energy form all **EM energy** packets of photons and all mass energy packets which form **matter**.

(4) Bound trees are interwoven with voids, to form fabrics of all space as omni-present **Space matrix (Space-Time-Energy)**, which represents three

interdependent components of Space, time and energy. Energy is proposed as positive **Fifth dimension of universe**.

(5) All voids of space matrix were fully curled up at the time of big bang which are slowly uncurling according to proposed value of cosmological constant and thus the periphery of universe is racing out at the speed of light by the force of this **dark energy**.

(6) Treos as bound treos are elusive **Dark matter particles** of universe and is responsible for Missing Mass of universe. One bound treo converts in one kinton, when it experiences a load of one free treo.

(7) Load is produced by all EM packets and matter packets as they **spread on its wave length** and exerts a load on each apex bound treo along its wave length. Equal number of kintons support load of free treos at each apex bound treo, as they get arranged according to proposed **column geometry** (in first and second dimension)

(8) $2n-1$ supporting units are in n th layer and n^2 in any n layered **kinetic column**. These units are kinton, orbitum, graviton and electron black hole, which form kinetic columns according to column geometry respectively in all four dimensions.

(9) One quantum load on space matrix is supported by one quantum kinetic energy or S kintons, in one unit time of one second (S vibrations), by **one EM wave** or by **one orbitum** and by S orbitums in graviton column it support one unit mass (S quanta mass).

(10) One **unit mass is the maximum load** which can be supported at one unit gravitational centre, at one bound treo i.e. one unit point in universe.

(11) Any M unit mass body exert a **load of M^2 unit masses** at its gravitational centre, which is supported by equal number of gravitons in its gravitational sphere.

(12) M^2 number of gravitons in its **n layered kinetic column of gravitational sphere** according to proposed column geometry (in third dimension as electron black hole and in fourth dimension as gravitational sphere of body) around its gravitational centre supports this load .

(13) This body exerts **2MG load at each** gravitational field quantum levels (total \sqrt{S} quantum levels in each dimension) ^[11] and total kinetic energy in $2n-1$ kinetic column (in n th layer from Sun), in this one layer at this quantum level supports this load by one matter wave.

(14) M number of graviton column unite to form gravitational field of this cosmic body which dilutes from 4 dimensional deformation in gravitational sphere to 3 dimensional deformation which contains the mass of this cosmic body and then extends in 2 dimensional deformation (in which form planetary orbits) and then it extends in 1 dimensional deformation up to \sqrt{S} quantum levels of in gravitational field of sun. In last concentric biggest peripheral layer of gravitational field one free tree load is supported by one kineton. ^[12]This is **Quantum gravitation**.

(15) Load of each one quanta EM energy (is supported by its one rotation of packet with its EM wave) or S free trees in one quanta mass energy (by S kinetons in one orbitum) is supported by one rotation of packet in S planes in one unit time of one second or S vibrations.

(16) While load of multiple unit mass energy packet is supported by multiple gravitons (each graviton supports one unit mass or S quanta mass energy) in one matter wave which have S orbitum in last shell (in \sqrt{S} sub shells) at last quantum level, in unit time of one second (S vibrations).

(17) Each quantum is supported from S directions by S kinetons in one orbitum with S vibrations which occur in one second. And thus multiple unit mass moving bodies **divides its load in its length of spread** with time and this has great impact on our day to day life (moving bicycle with lesser angular momentum does not fall, or an airplane can fly ,etc).^[4 f]

(18) Increasing load of increasing EM energy or mass energy in packet, at each of \sqrt{S} quantum level in each of four dimensions adds one layer in kinetic column of this dimension. The changing geometry of unit space matrix with its layer by layer increasing deformation at each next quantum

levels in all three dimensions of space, contracts our space which is discussed above. These kinetic columns are fields of all four basic forces; and this marks **unification of all forces**.

(19) The transfer of each quanta energy from photon, electrons, any elementary particle, any thermodynamic transfer of heat (un matched energy goes to thermodynamic sink), transfer of kinetic energy which increases speed and momentum, any biological or chemical energy transfer; is **transfer of integral number of full kinetic layers from all columns in wave of donating body to receiving body**.^[4g]

(20) The increasing number of protons (with increasing Z number) in atomic nucleus initiates a reaction and the orbits formed by this deformation at atomic quantum levels^[4h] are filled by electrons, which **thus produces all 118 elements**, placed in 7 groups of periodic table.

Bibliography

- (1) Ashok Saxena, 2005; *Inside a Wave, paper cover book*, (India), Manas Prakashan. Pp 196 (Copy right of book no. L-36882/2010/19-11-2010)
- (2) Ashok Saxena, 2015; *Our universe and how it works; (Quantum gravitation and Fifth dimension)*, (India) hard copy pp 87 ISBN 978-93-5235-003-2 (Manas Prakashan); 2016 e-book, ISBN 978-93-5235-065-0 Book baby.
- (3) Ashok Saxena; 2020; *Treo Model of Structure and Working of Universe (Cosmic code)*, (INDIA) ISBN 978-1-64828-887-6 paper back, pp 84, Notion press; e- book ISBN 978-1-64828888-3 (Notion press). Copy right application no, L-94591/2020.
- (4) Ashok Saxena et al. 2020; *Treo model of Structure and working of universe, cosmic code*. viXra org > Quantum

gravity and string theory> Pp a 84, b 70, c 67, d 67, e 96, f
193, g 190, h 165 ; viXra:2011.0155 Pdf

- (5) Higgs, peter; 1964, ***Broken symmetries and the masses of gauge bosons***, Physical review letters13 (16) 508-509.
- (6) Y. Valdimirov, N. Mitskievich & J. Horsky, 1987; ***Space Time Gravitation***, Mir publication.
- (7) Rinhard GenZel, Frank Eisenhauer & Stefan Gillessen ‘***The galactic centre massive black hole and nuclear star cluster***’ book; university of California, berkeley.
- (8) НИКИТИН А П. ***Cosmophysics*** (RUS)
<http://vixra.org/pdf/1709.0296v1.pdf>
- (9) Ashok Saxena et al. ‘***Position of Baby bodies in any gravitational field***’ <http://vixra.org/abs/2011.0097:v1.pdf>
- (10) Ashok Saxena et al. ‘***confirmation of Treo model outside solar system***’ <http://vixra.org/abs/2011.0096:v1.pdf>
- (11) Ashok Saxena et al; ***Treo model, Structure and working of universe, unification of forces and quantum gravitation.***
<http://vixra.org/abs/2012.0167:v1.pdf>
- (12) Ashok Saxena et al; ***Treo model, Structure and working of universe, Space matrix, Fifth Dimension & cosmic code.***
<http://vixra.org/abs/2012.0165:v1.pdf>

