

A Fifth Force Vacuum Dipole Repeller, Needed to Create all Attraction Forces even around Black Holes in Quantum FFF Theory.

Leo Vuyk,
Architect,
the Netherlands.

Abstract,

Quantum FFF (Function Follows Form) theory is a Rigid String Theory which states, that there are no singular string based attraction forces.

The vacuum is seeded with fast oscillating massless Axion/Higgs particles, oscillating along a complex chiral tetrahedral vacuum lattice, which has the ability to transfer Photon and Graviton information in wavelength bunches of oscillations, through the vacuum lattice with the local (mass related) speed of light and the origin of the so called Dark Energy observed e.g. in the Casimir effect.

As a consequence there are no singular attraction forces on rigid stringy knots of propeller shaped Fermions. Only the sum of the different kinds of vacuum impulses with the local vacuum oscillation spectrum coming from all directions on Fermions are responsible for all energetic phenomena in the universe.

At the same time we may call this force a fifth force as it opposes and interacts or compensates all Photon/Gluon pressure effects on fermions in the universe.

As a consequence New physics will be needed and the introduction of Quantum based monopole radiation fields like electric and magnetic monopole fields.

The gravity around Black Holes is assumed to be based only on the zero point oscillation spectrum from outside the black hole without the opposing repulsive gravitons.

Black holes don't emit gravitons, consequently they are massless and harbor a nucleus of massless Axion/Higgs based Quantum knots only able to absorb the incoming oscillating vacuum particles.

All Star-Planet systems are supposed to be stabilized by at least two polar local black holes. Interpreted as Herbig Haro systems, these black holes polarize the vacuum around the sun with butterfly shaped fifth force vector bubbles around test masses

As a consequence, in the middle of these solar Anchor black holes (SABHs) the gravity around the sun has a relative instantaneous "anomalous" relation with the gravity centre of the sun.

Emerging gravity effects called "dipole repeller gravity", between galaxies and Galaxy clusters seem also a support for the fifth force vacuum pressure gravity postulate.

Introduction.

A parallel with Le Sage gravity.

According to the so called Le Sage gravity, the vacuum is seeded with fast travelling corpuscles, impinging on mass carrying particles present inside massive bodies.

The deflection of these vacuum particles after the impulse on the first body, should lead to a decline in vacuum pressure on a second object, tending to drive two bodies together.

However, Q-FFF Theory suggests, that the vacuum is seeded with fast oscillating energetic but massless Axion/Higgs like particles, oscillating along a complex chiral tetrahedron vacuum lattice, which has the ability to transfer Photon and Graviton information in wavelength bunches of oscillations, through the vacuum lattice with the local speed of light.

As a consequence there are no attraction forces on the propeller shaped spinning Fermions. Only the sum of the different kinds of vacuum impulses from all directions on Fermions coined: “**Double Vector Hedgehogs**”, are responsible for all energetic phenomena in the universe.

We may call the local double vector Hedgehog also: a dual repulsive vacuum oscillation spectrum with a constant a-symmetrical zero point Casimir effect, able to insert attraction and repulsion forces on Fermions.

The Lorentz forces need however also a Magnetic curving force.

Thus we could give such a gravity model the name: “**Double Le Sage gravity**”. Fermions are assumed to be fast spinning 3 Dimensional propeller shaped strings, able to deform impinging Axion/Higgs particles into 5 different shaped 3-Dimensional Photon/Gluon particles and Gravitons. (Figure 2).

In contrast with the contemporary “standard model”, we count two Gluon/Photons (coded: LOL+ROR) for the electric quantum force, two Gluon/Photons (LOU+ROU) for the magnetic quantum force and one Gluon/Photon (UOU) as general particle for the x-ray, gamma ray and different light frequencies.

The 5 different shaped Gluon particles are in contrast with Gravitons, supposed to be able to merge with Fermions into more complex compound Fermion particles (Quarks, including Muons and Tau Fermions). However if no Fermions are hit by the Gluon, then after a very short (Planck) distance the Gluon information is picked up and transferred as 5 types of different coded monopole Photon information or as a Graviton encoded information.

(figure: 1,6)

This seems also a support for the so called particle-wave duality.

The bunch of Higgs oscillations can impinge somewhere on a new Fermion and then the Photonic wave function will collapse and change back into one Gluon particle, able to merge with the Fermion and originate measurable atomic change (like the photon collision with a silver atom).

All Star-Planet systems are supposed to be stabilized by at least two polar local pre-stellar Herbig Haro black holes. These black holes polarize the vacuum around the star with butterfly shaped Axion/Higgs pressure vector bubbles (figure 17)

As a consequence, in the middle of these Solar Anchor Black Holes (SABHs) the gravity around the star has a relative instantaneous relation with the gravity centre of the sun and is supposed to have an (anomalous) instant effect.

As a result, the speed of gravity ONLY around the sun exceeds the speed of light. The 3 dimensional structure of the repulsive butterfly shaped oscillating Axion/Higgs field vacuum vector bubbles is supposed to be the origin.

Quantum Dipole Repeller Gravity pushing our Galaxy.

According to Quantum FFF Theory, empty space is filled with a fast oscillating lattice of massless Axion-Higgs field particles as a half base for our opposing dipole pressure Higgs-graviton gravity on earth. Now prof. Yehuda Hoffman shows us a support for this hypothesis.

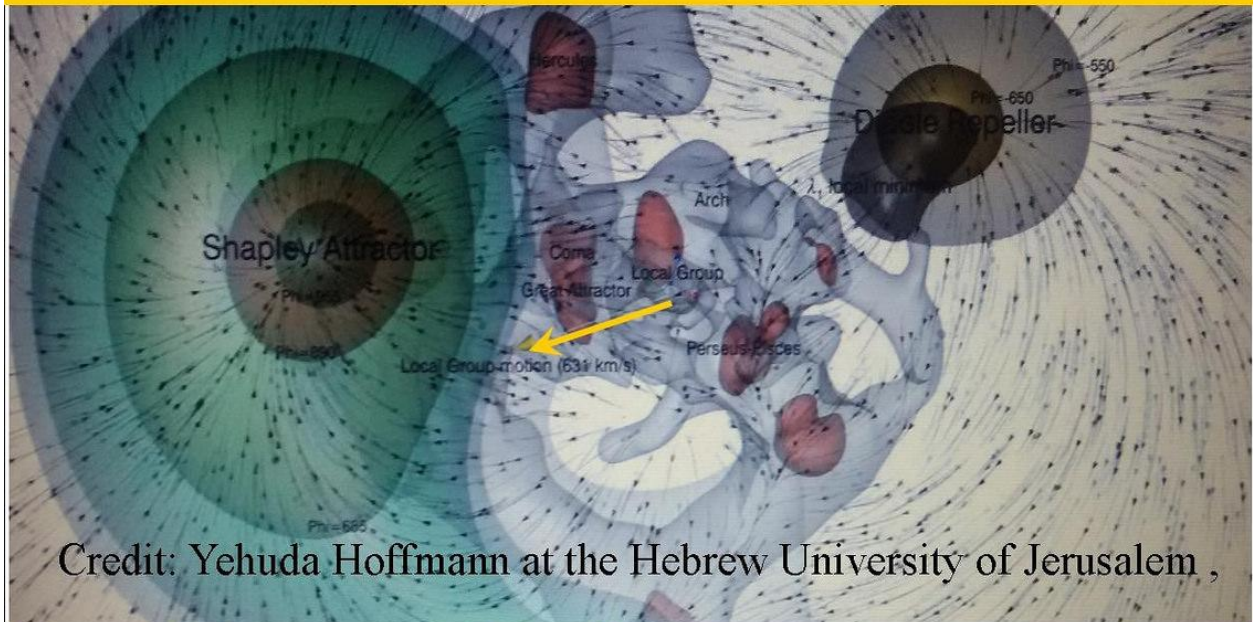

Quantum Gravity as pressure distribution of the oscillating dual Higgs/Graviton vector field.

New Dark Matter Black Hole, "Eat" the chiral oscillating Higgs vacuum.(Quantum-FFF Theory)

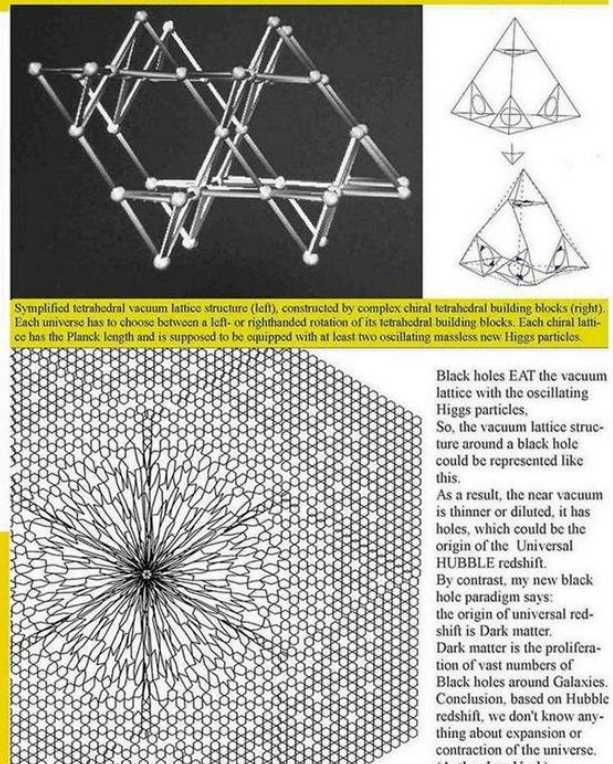
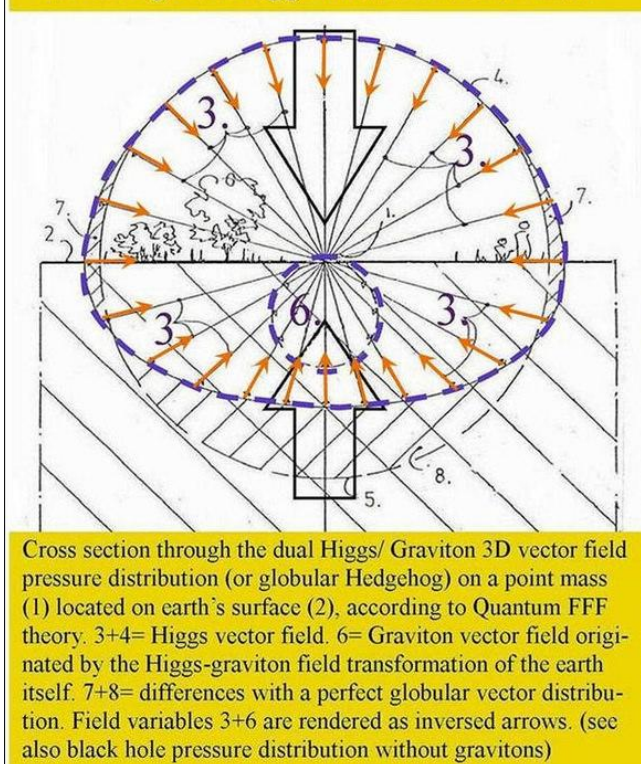

Figure 1, "Dipole repeller gravity" according to Yehuda Hoffmann and the relation with Electric Dark matter Black Hole gravity of Quantum FFF Theory..

Sterile Neutrinos and Majoranas seem to have different origins according to the 3x hinged rigid string system of Quantum Function Follows Form model.

MAJORANA particle's placed in the new extended standard model based on Q-FFF Theory. OOU is e-e+ related, UUU, LUL,RUR are Neutrino related. Called sterile Neutrinos.

The coding of Single Elementary Particles is based on the so called "rotational click positions" of the three hinges, which are assumed to be regularly placed over the ring shaped Higgs "Quantum Tons Particle" (page 2). This ring has one splitting point and three hinges which have consequently four 90 degree click positions each. The best Tons ring diameter ratio to click-on is about 1/7. The ring coding of the hinges positions is as follows.

Explanation of the codes:
 U= Up rotation (180 degrees)
 O= Unchanged circle
 L= Left rotation (90 degrees)
 R= Right rotation (90 degrees)

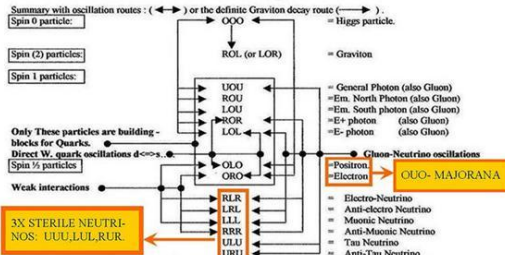

Higgs particles are supposed to oscillate in Tandem along so called linear Vacuum Lattices, two by two in opposite directions, as the symmetrical opposite pistons of a boxer engine, as the origin of all energy, spin and mass effects. This enables the Tandem Higgs particles to change the form of their own Tons into an Electron and Positron pair at

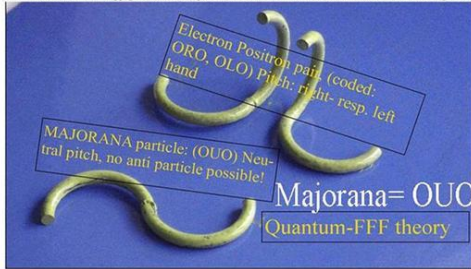

Geometrical proposal for most particles building the universe



Geometrical proposal for the sub-quantum structure of 6 Leptons and Quarks interpreted as compound Photon/Electron Positron propeller combinations. Muon- and Tau particles seem to show up as family members of the Down respectively Charm Quarks. According to Quantum FFF Theory. (Function Follows Form in particle physics)

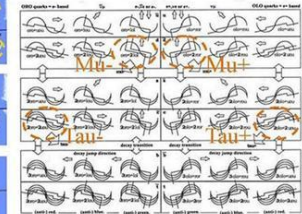

All Photons (1x, graviton, 2x electr.- 2x magnetic- and 1x general (x-gamma-ray) photon) and two Fermions (Electron + Positron) are formed direct out of the "Mother" ring shaped Higgs particle, by internal hinge rotation (below). Dark Matter particles are supposed to be formed by interlocking 3 or 4 photons (below). Neutrinos are deformed photons or fermions. (not shown) See Quantum FFF Theory. (Function Follows Form) <http://vixra.org/abs/1103.0002>



↓ 3D base for 3x hinged rigid strings.



OOO,-ROL-UOU,ROU,LOU,ROR,LOL,-OLO,ORO-RUR,LRL,LLL,RRR,ULU,URU.

Figure 2, 3-Dimensional String Based Alternative Particle Model.

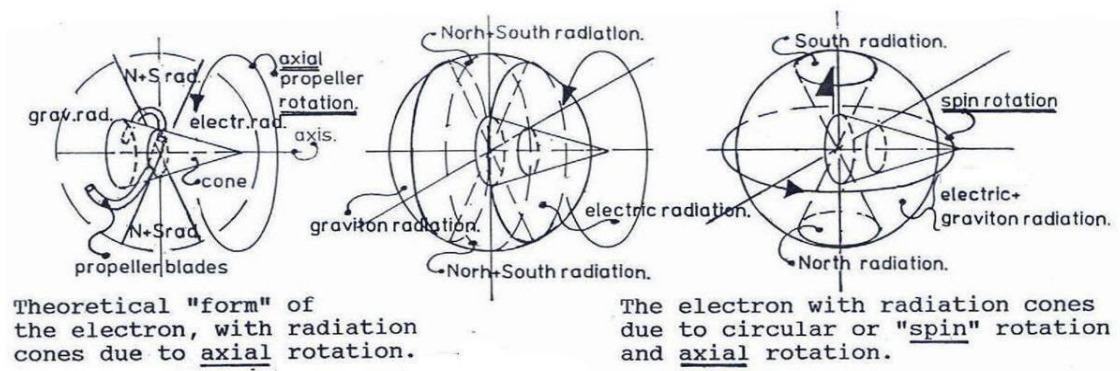
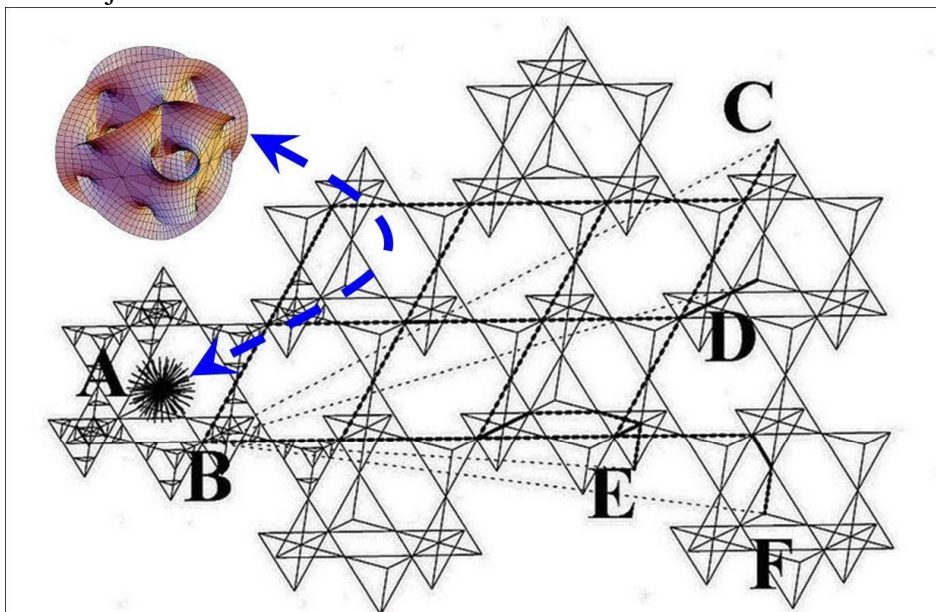

Figure 3, Double axial spin of Fermions with monopole Gluon- Graviton radiation cones. Inside a nucleon, after a short distance the 5 different string shaped Gluons (2x Electric, 2x Magnetic and one General photon) are able to exchange and merge with Fermions into compound Quarks, or after about 1 cm, become part of a photonic quantum wave, outside the nucleon just like the Graviton.



Photon trajectories through the tetrahedral oscillating Higgs vacuum lattice. (Acc. to Quantum FFF Theory)

- A: a real shaped Photon is created by Higgs collision with a dual axis spinning (Calabi Yau) Fermion propeller.
- B: that Photon transfers CODED form information (monopole photon info) and direction information into one Higgs particle which transfers this information by mutual Higgs collisionary oscillations through the vacuum in one specific direction. C,D,E, or F.
- I: Only magnetic photonic information (2x : North and South) are subject to curvature by an undisturbed symmetric oscillating vacuum
- II: Local Anti-Symmetric Oscillating vacuum Frames are influenced by massive objects like the earth and responsible for semi relativistic effects.
- III The vacuum lattice has helix- or chiral quality being the origin of our material universe.

Figure 4, Photon (bunch shaped) trajectories, through the Higgs vacuum lattice.

Alternative Feynman diagrams with additional ZPE vacuum Higgs impulses, combined with electric and magnetic monopole photon impulses, according to Quantum FFF Theory

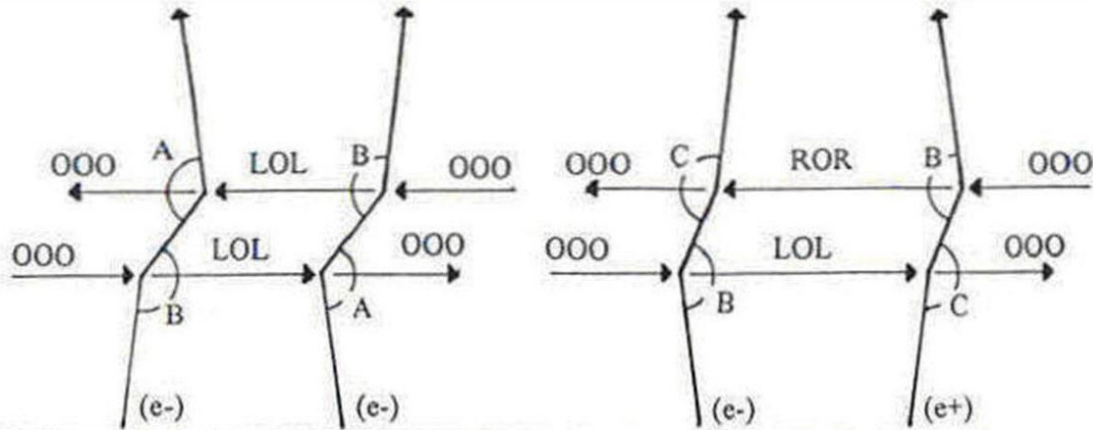

Higgs (OOO), Neg. Photon (LOL) Pos. Photon (ROR) all change form after collision with Fermions

Higgs impulse diagram for Double LeSage Gravity, according to Quantum FFF theory.

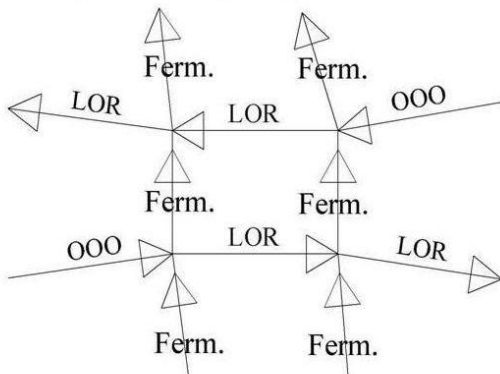

Fermionic impulse differences with Higgs (OOO) and pushing Gravitons (LOR).
OOO changes form after collision into LOR.
Gravitons don't change shape after collision.

Higgs Impulse diagram for MAGNETIC monopole radiation, according to Quantum FFF theory.

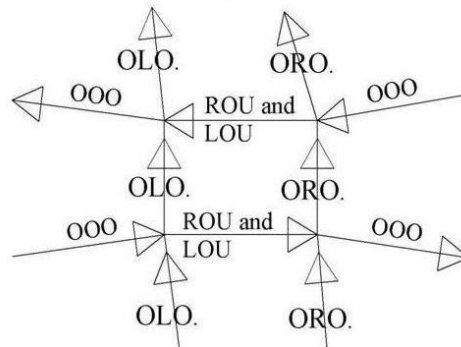

Fermionic impulse differences between Higgs (OOO) and TWO Magnetic monopole photons (LOU and ROU) on Fermions (OLO and ORO).
OOO changes form after collision with OLO resp ORO into ROU and LOU and after second collision back again into OOO.

Quantum Gravity (left) and Magnetic forces (right). Vacuum Higgs Chirality and particle geometry and spin plays an important role

Figure 5, Vacuum Axion/Higgs field (OOO) fifth force in action opposing all other gluons/Photons.

Quantum Gravity as pressure distribution of the oscillating dual Higgs/Graviton vector field.

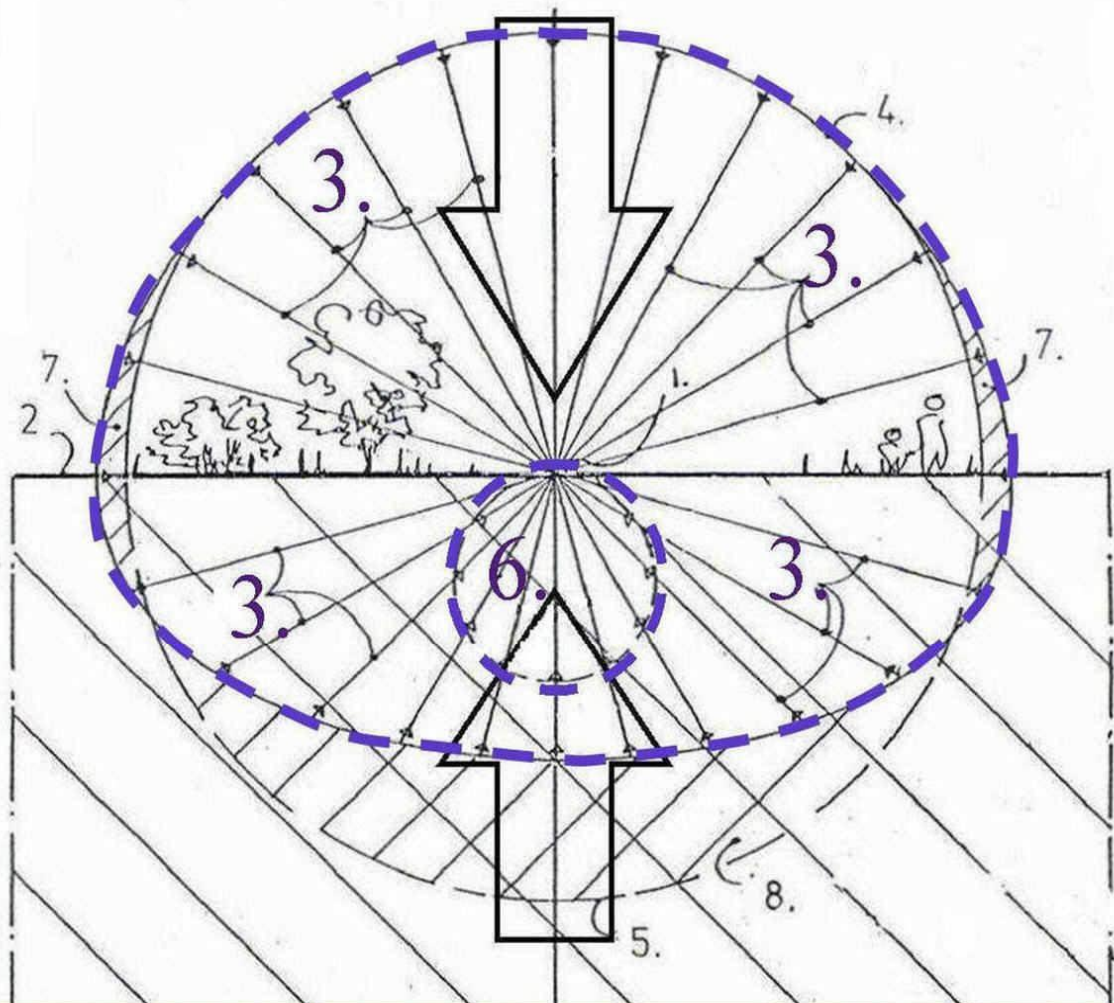

Cross section through the dual Higgs/ Graviton 3D vector field pressure distribution (or globular Hedgehog) on a point mass (1) located on earth's surface (2), according to Quantum FFF theory. $3+4$ = Higgs vector field. 6 = Graviton vector field originated by the Higgs-graviton field transformation of the earth itself. $7+8$ = differences with a perfect globular vector distribution. Field variables $3+6$ are rendered as inversed arrows. (see also black hole pressure distribution without gravitons)

Figure 6, Cross section of the “**Double Vector Hedgehog**” of pushing forces around Fermions. The difference between Higgs vacuum pressure (3) and less effective Graviton pressure (6) on Fermions are the basic elements of Double Le Sage gravity.

Higgs/Graviton pressure vector hedgehogs acting on a mass carrying Quantum particle. The irregular distribution of mass inside the earth is supposed to influence the 3D pressure vector hedgehog according to the new Double LeSage gravity paradigm, see image below.

Author Leo Vuyk.

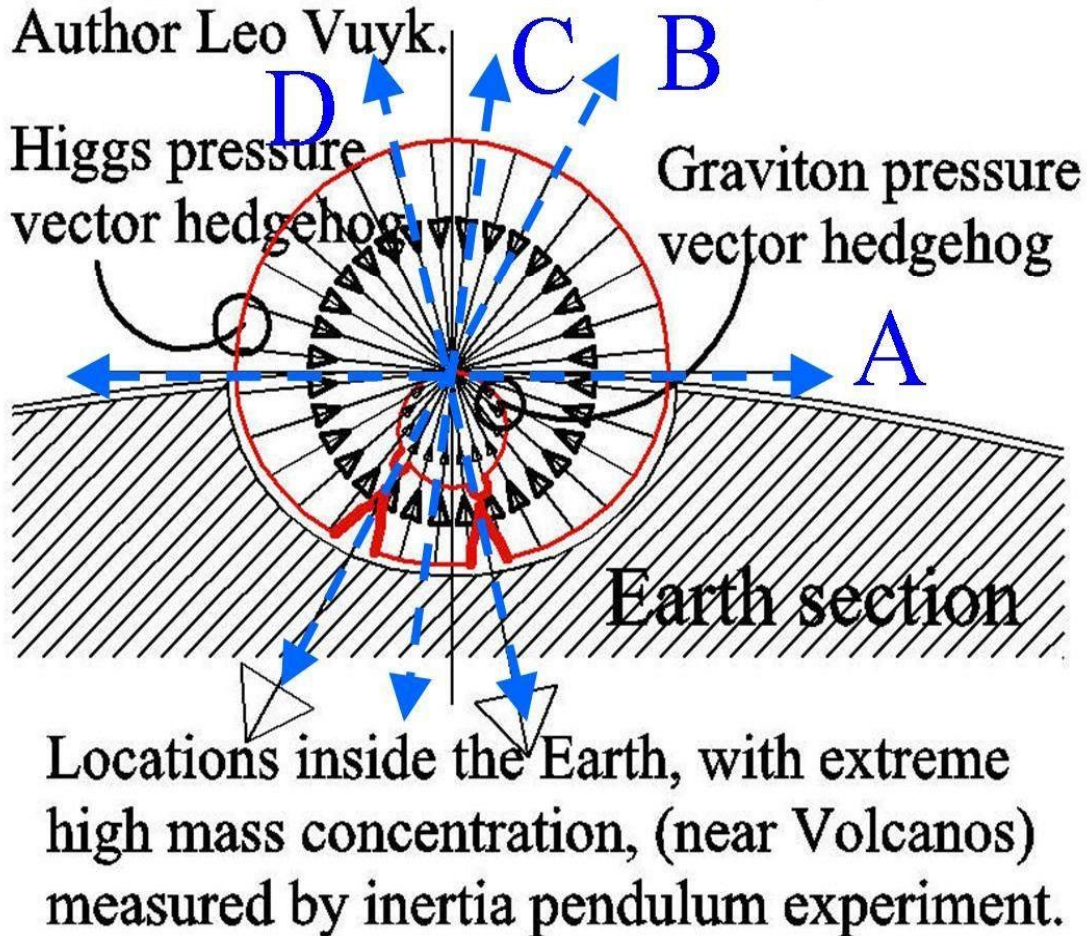

Figure 7,

The “**Double Vector Hedgehog**” related to mass concentrations in the earth.

Internal crashed Comet black holes inside the earth, seem to be able to align two by two and create local gravity anomalies and volcanoes. (see: ref 110)..

ALTERNATIVE MAGNETIC FIELD INTERPRETATION.

If magnetic field lines have a quantum mechanical origin, based on alternative magnetic monopole photons (with a North or South characteristic and a slight "photonic trajectory CURL") then the picture below could represent the origin of a "Magnetic vector potential (A)" around an electric current e.g. in a wire.

This magnetic CURL is supposed to have the same origin as assumed for the DIFFRACTION process (of light): "Settlement" of photonic information routing inside the local microscopic Higgs vacuum lattice.

It is assumed that the photonic CURL in the photonic vector field will change due to wire bending.

The Curl will be able to decrease down to zero curl, at the outside turn of a bended wire, (e.g. see position: a) If this is the case, the magnetic field (called the B field) will vanish completely around a long small solenoid. Inside a wire bending however, the Curl will consequently increase.

Conclusion, the proposed two force carriers (photons: North and South) are able to explain the peculiar qualities of the so called Magnetic Vector Potential field (A). (Author L.Vuyk)

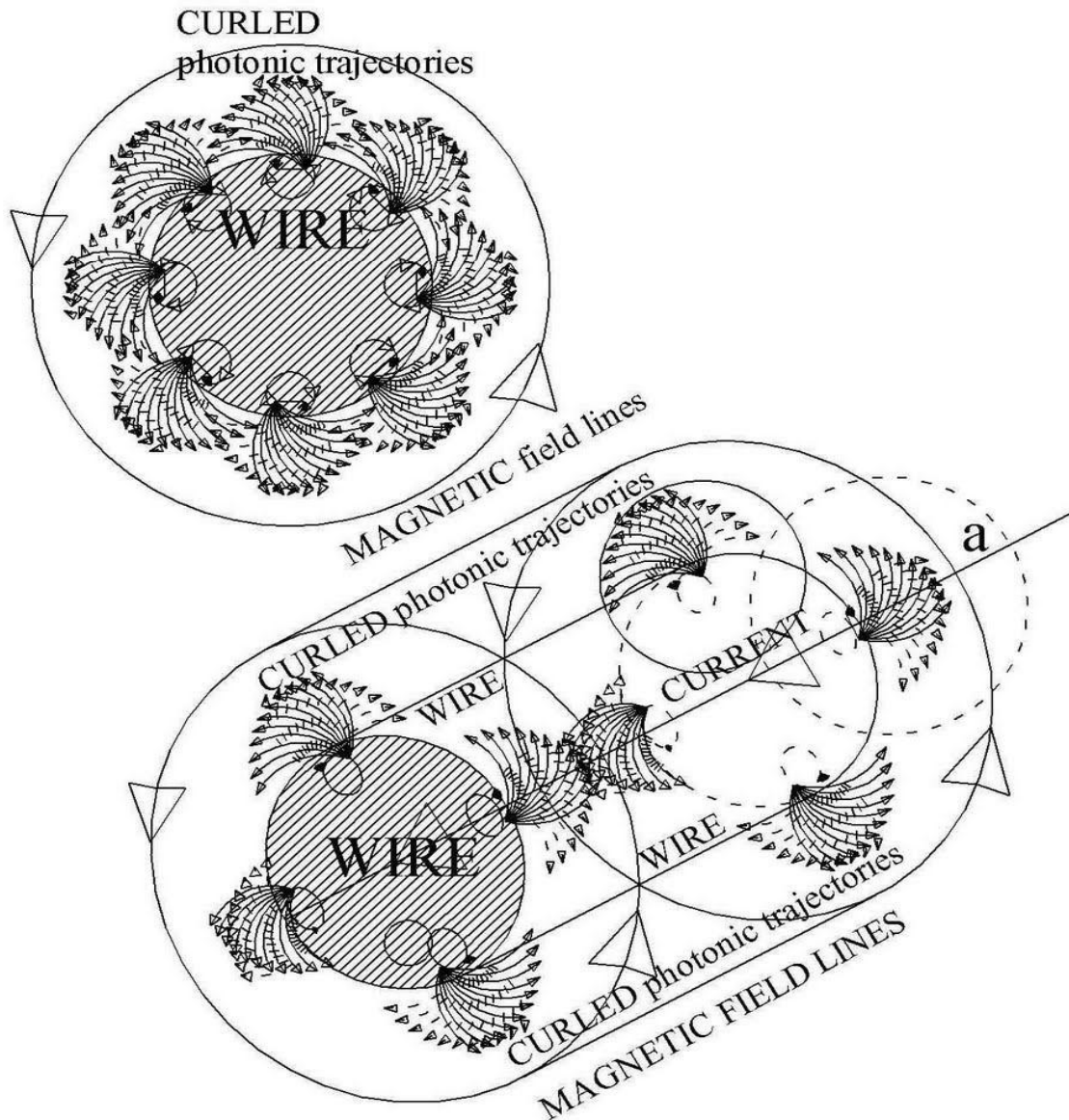

Figure 8, Alternative magnetic field by "curled Photonic monopole information" around an electric wire under current.

ALTERNATIVE magnetic field interpretation based on two different magnetic photons (N and S) with boundary layer elevation indication. If magnetic field lines have a quantum mechanical origin, based on alternative magnetic monopole photons (with a North or South characteristic and a slight "CURL") then the picture below represents the differences with the traditional view.

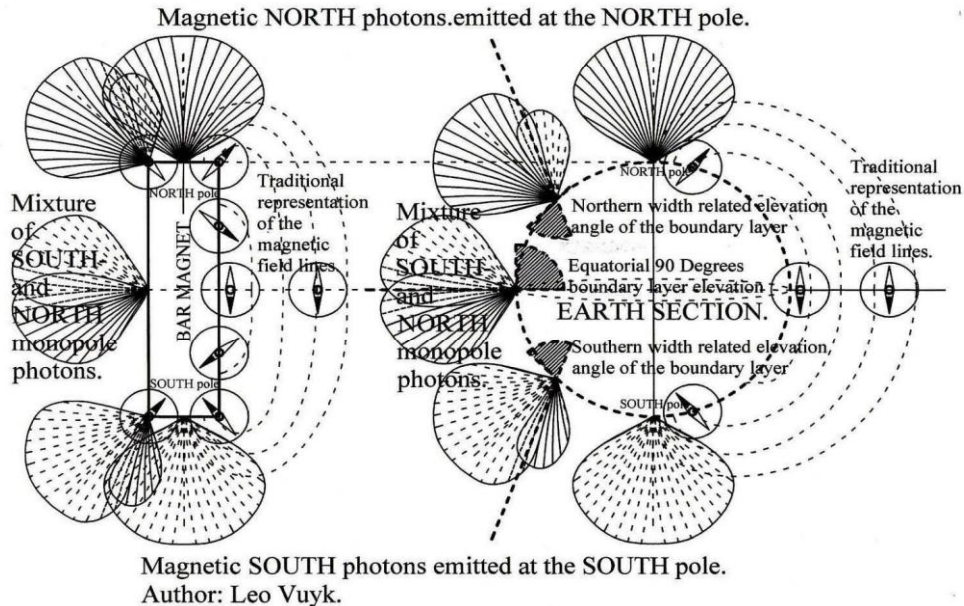

Figure 9,

Alternative magnetic field interpretation , based on two different magnetic Photon/Gluons (North and South) with different boundary Layer elevation indications. The 5 Gluons are supposed to be the same as Photons however with different appearances. Gluons are supposed to be real 3-Dimensional strings, able to “click-on” to Fermions to form Quarks. Photons are supposed to come only in wave form, as monopole information bunches travelling with the local speed of light along the mass-less oscillating Higgs vacuum lattice. The are transformed Gluons

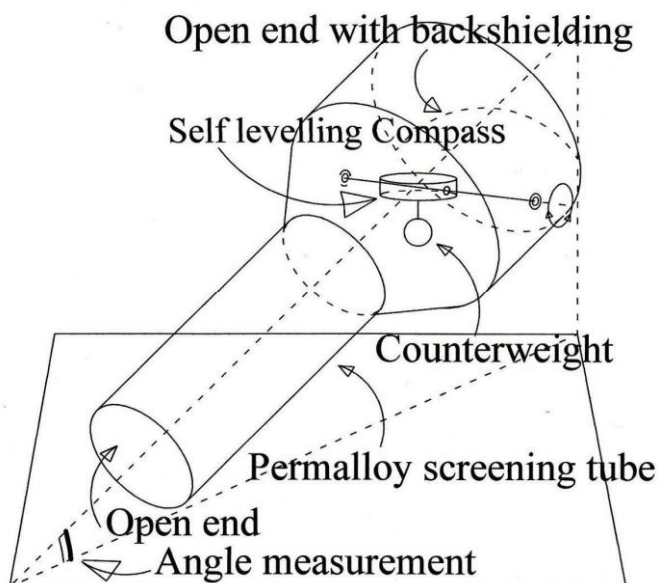

Figure 10,

3-Dimensional representation of the magnetic monopole telescope, able to show differences in the monopole Photon trajectories (with North or South characteristic) around the earth. The screening tube with back shielding, is made of permalloy or mu-metal. The compass is a simple hobby compass balancing on copper bolts. Angle measurement is done, only if the compass needle

points into a heading perpendicular to the axial symmetry axis of the tube. See the result on figure 11.

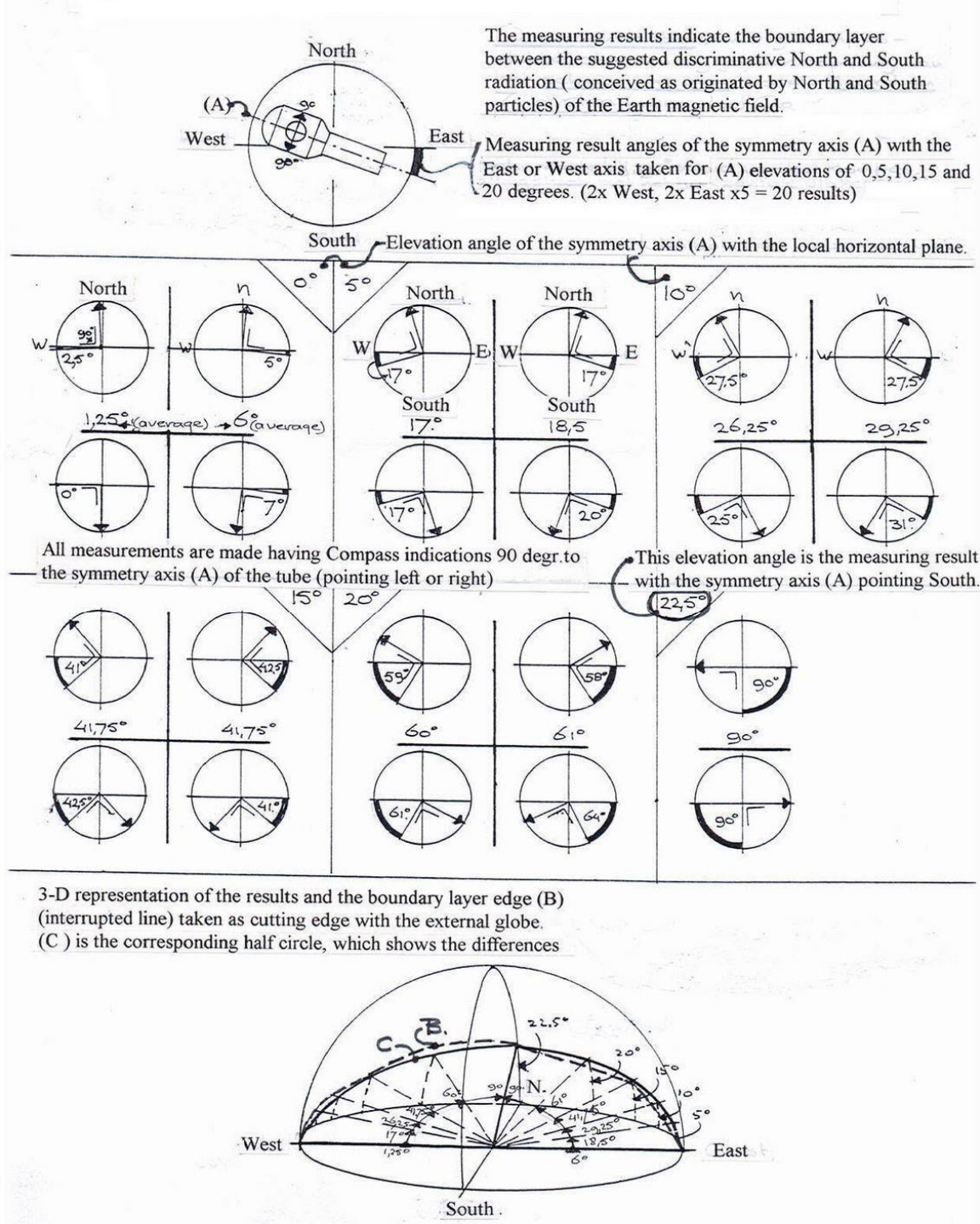
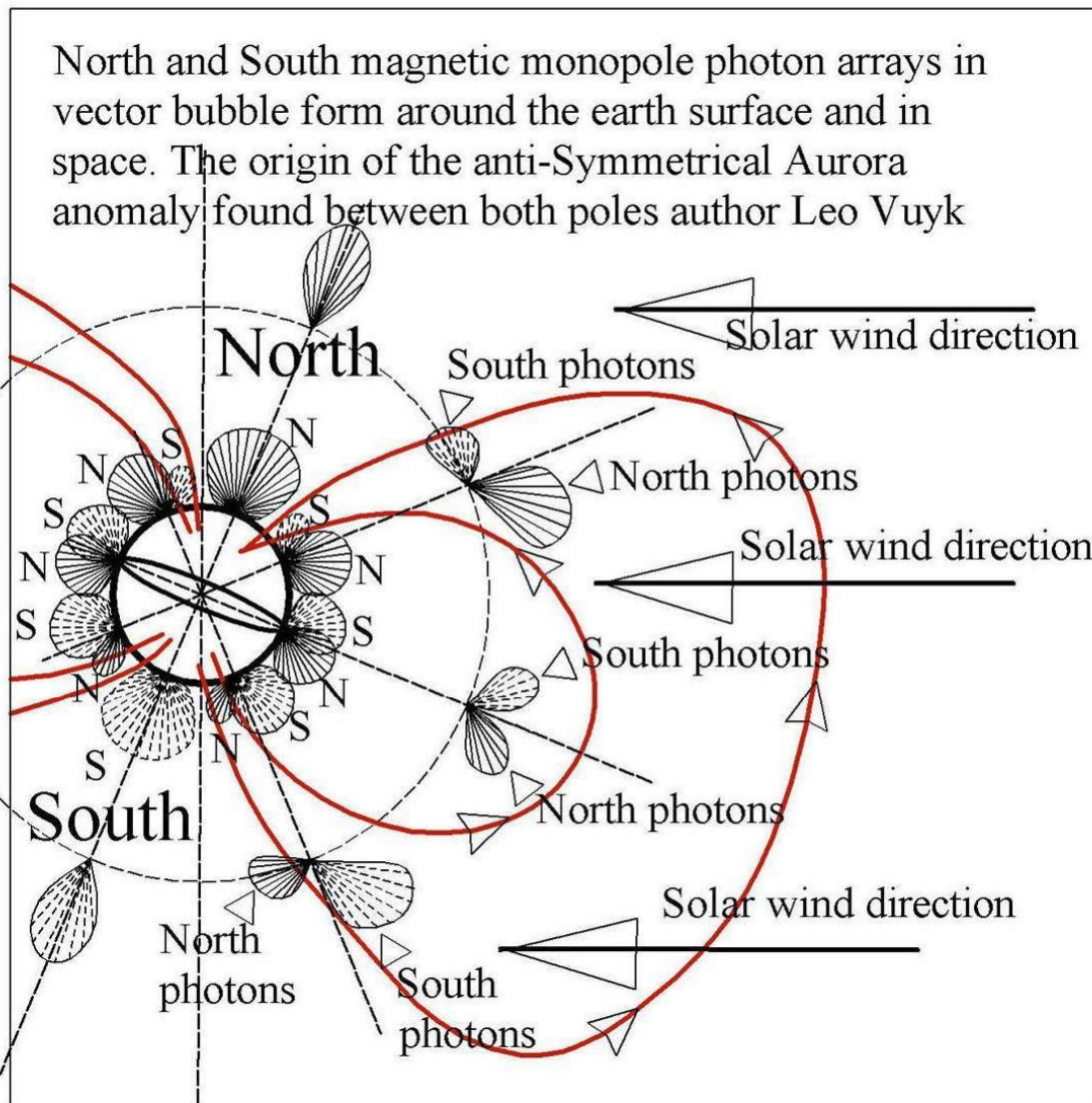

Figure 11,

3-Dimensional representation of the “boundary layer” B, between the North and South monopole radiation of the earth, is the result of multiple measurements by the magnetic telescope at location, Latitude: 52,18 degr. North and Longitude degr. 5,2 East.

It is assumed that every location on earth has its individual **boundary layer Curve B.**

It is also assumed that **animals like Pigeons and sea Turtles are able to identify these specific curves (B) for different locations by the small amount of permalloy alike metals already found in their bodies, to explain the extraordinary qualities of animal orientation.**



Section through the earth with magnetic monopole photon arrays in vector form. The Magnetic curl effect in space is influencing the vector bubble directions and shapes. Date 12-01-2012.

Figure 12, North and South monopole photon vector arrays around the earth. The North photon angle of attack and concentration on the Solar wind charged particles is assumed to be the origin of the recently found anti-symmetry of aurora effects in the summer.

Polar Auroras do occur at the same time in northern and southern polar regions at locations connected by geomagnetic field lines, a connection that might be expected to link patterns, positions and timing of the two aurora.

However this is found to be not the case!!

See: Asymmetric auroral intensities in the Earth's Northern and Southern hemispheres

K. M. Laundal & N. Østgaard. doi:10.1038/nature08154.

Magnetic field variations by the “Curl” of Magnetic Monopole (N and South) Radiation around a wire and the earth.

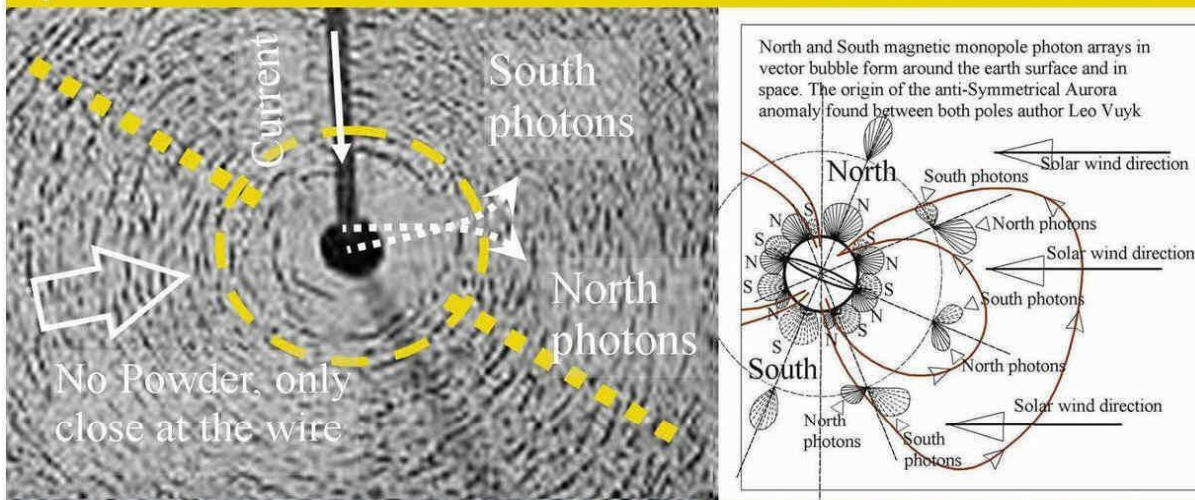

According to Quantum FFF theory, all magnetic fields can be presented as DUAL Magnetic Monopole Photon Vector Arrays. These monopole arrays undergo curvature. As a result, the magnetic field intensity around the Earth and a wire is NOT dropping off with the square of the distance from the source!! The field become stronger polarized away from the source (See images). Close to the current transporting wire the magnetic field strength is zero due to the parallel trajectories of North and South Photons before curvature and polarisation of iron powder (Author: Leo Vuyk)

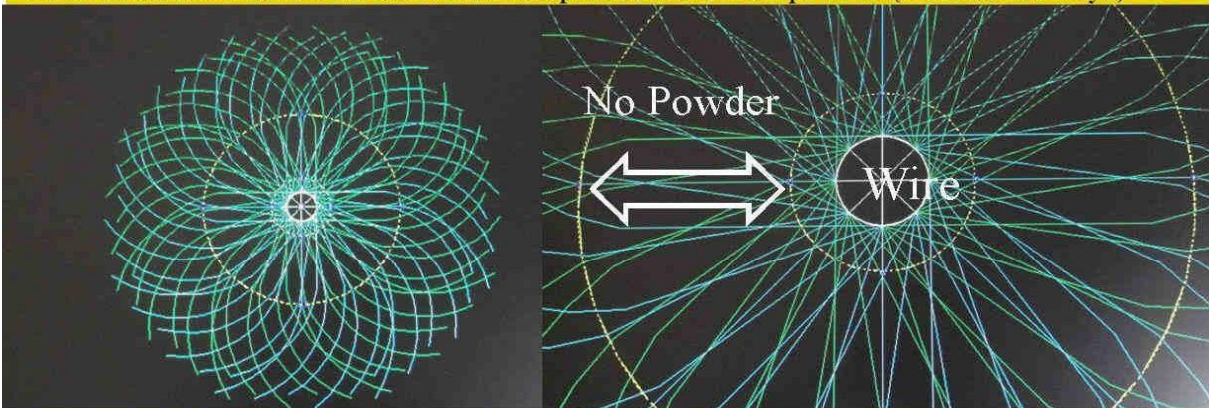

TWO (North and South) Monopole Photon trajectories around a current in a wire shown in cross section. Between the two yellow circles both (N+S) trajectories are pointing about parallel. The result: No iron Powder orientation between the concentric circles, as is observed in the lab (see upper photo). This is a firm support for the monopole photon vector array element of Quantum FFF Theory.

Figure 13, Magnetic Field intensity is only at polar regions dropping with the inverse cube of the distance from the source.

However the so called CURL of the magnetic vector arrays around the earth, permanent magnets and around current bearing wires, is the origin of a strange anomalous less pronounced drop of the field strength related to the source.

Synchrotron radiation by Polarized Fermion spin combined with high speed motion through the resistive oscillating Higgs vacuum (according to Quantum FFF theory)

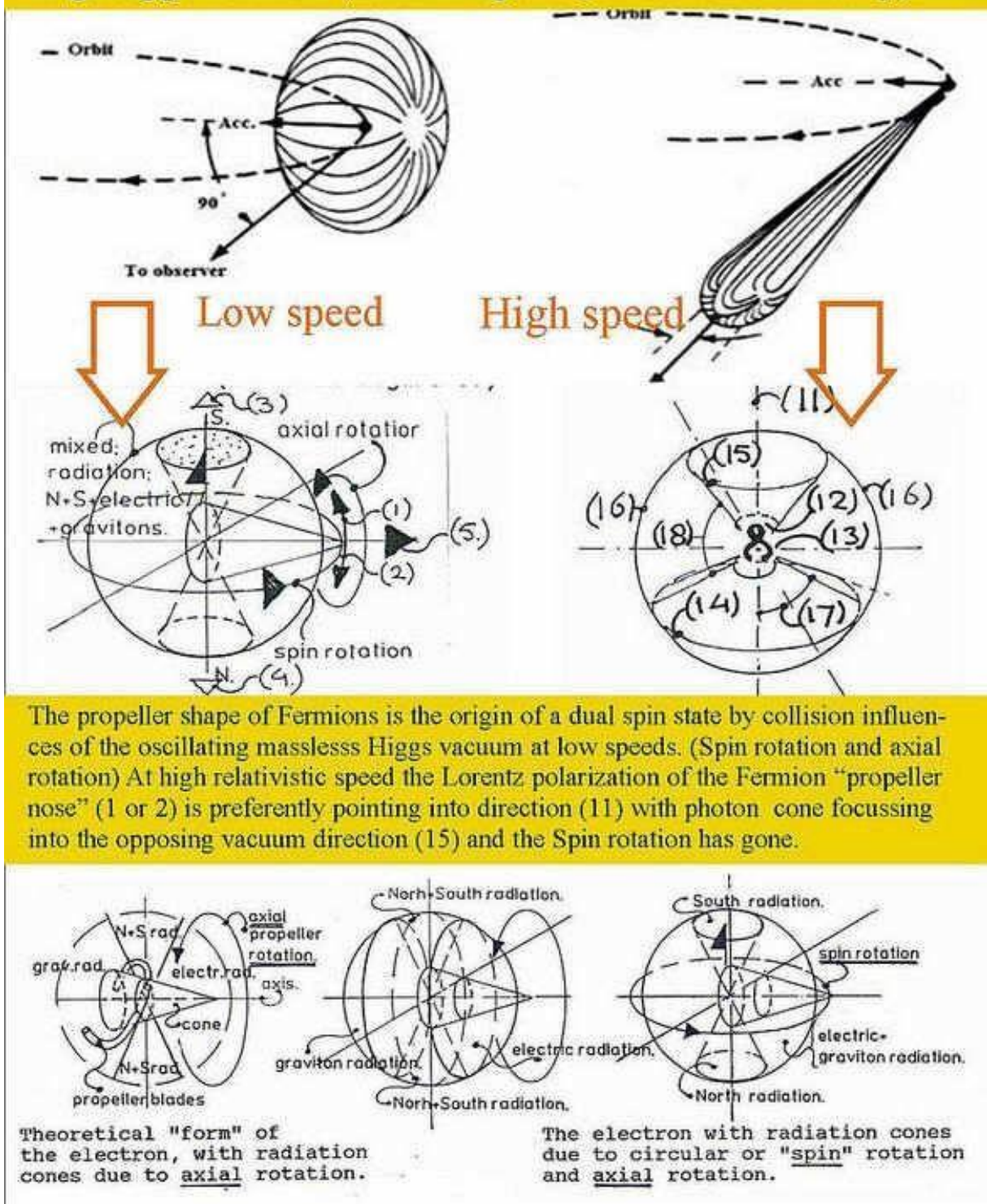

The propeller shape of Fermions is the origin of a dual spin state by collision influences of the oscillating massless Higgs vacuum at low speeds. (Spin rotation and axial rotation) At high relativistic speed the Lorentz polarization of the Fermion "propeller nose" (1 or 2) is preferably pointing into direction (11) with photon cone focussing into the opposing vacuum direction (15) and the Spin rotation has gone.

Figure 14, Examples of how the double spinning Fermions are reacting on the oscillating massless dark matter Higgs vacuum in the case of relative speed and gravity.

A hotspot for powerful cosmic rays found under the Big Dipper, by the University of Utah. The mysterious source of cosmic rays is also reason to look at the southern hemisphere to observe the opposing second Stellar Anchor Black Hole (SABH) (Cosmic ray production by NEW black hole paradigm according to Quantum-FFF Theory).

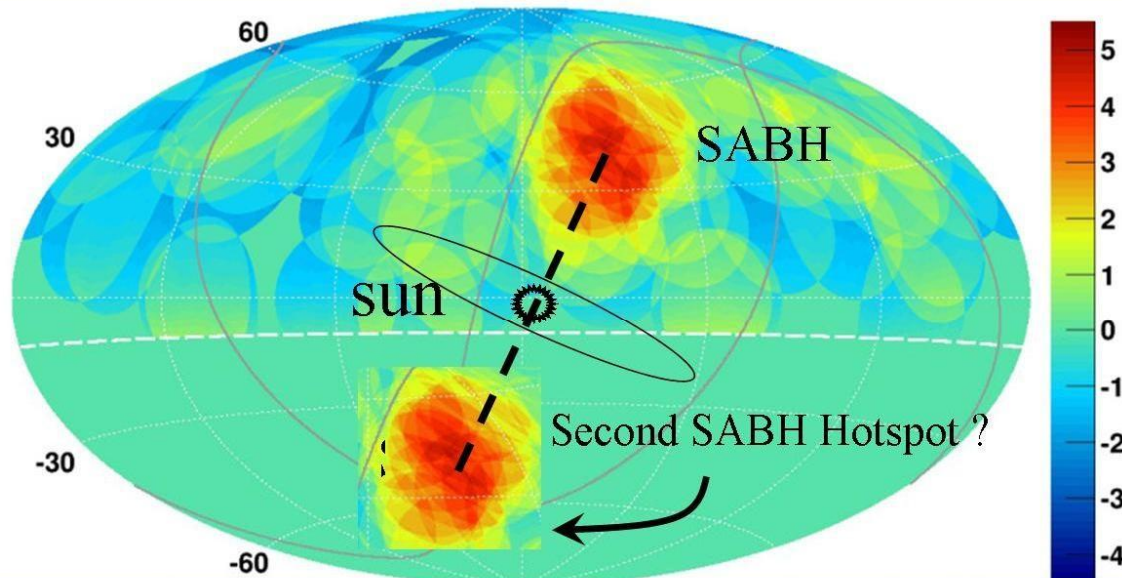

According to Quantum FFF Theory, “New Black Holes produce Proton– Electron plasma. By the strong Casimir vacuum push gravity on the BH, the “Lighter” electrons will stay outside the “heavier” proton horizon (blue). As a consequence BHs have a strong electric potential, which is liberated by asymmetric processes in dual BH systems like Herbig Haro objects showing strong electro magnetic effects in open cluster star formation and Birkeland Alfven circuits around the earth and even in the so called BICEP 2 results.

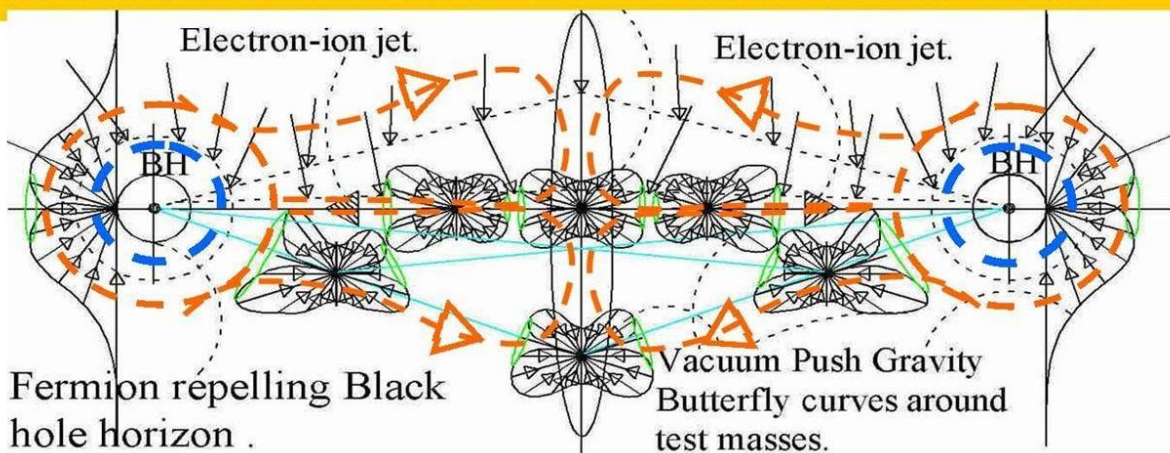

Scheme of the electric SABH principle around the sun.

Figure: 17, The speed of gravity ONLY around the sun exceeds the speed of light and is supposed to have an instant effect.

The 3 dimensional structure of the repulsive butterfly shaped oscillating Higgs field vacuum vector bubbles is supposed to be the origin.

References:

- [110] [viXra:1806.0298](#) Expanding Earth, by Growing Water based Crashed Comet
- [109] [viXra:1806.0068](#) Primordial Electric Dark Matter Black Holes Outside Galaxies
- [108] [viXra:1805.0541](#) Tidal Star Disruption Events (TDE) by Fermion Repelling Black Holes in Quantum FFF Theory.
- [107] [viXra:1805.0307](#) Fulgurite Created by Lightning Bullet Also Known as Ball Lightning, According to Quantum FFF Theory.
- [106] [viXra:1804.0138](#) Dark Matter Black Hole Galaxy Hierarchy According to Quantum FFF Theory.
- [105] [viXra:1803.0100](#) Free Will Readiness Potential Ratios, the Key for a Multiverse Number Calculation.
- [104] [viXra:1803.0093](#) Skyrmion Interference Black Holes, Photonic Molecules, Ball Lightning, Micro Comets, Sprite-Fireballs and Sunspots According to Quantum FFF Theory.
- [103] [viXra:1801.0121](#) Quantum FFF Theory, a Conscious String Theory with Different Vacuum Trajectories for Axion-Higgs Field/ Photons Respectively Fermions,
- [102] [viXra:1801.0040](#) A Consciousness Theory of Everything based on Rigid Transformable Strings, Instantly Entangled Between 8 or 12 CP Symmetric Universal Bubbles.
- [101] [viXra:1712.0349](#) Tabby Star's Support for New Physics Starspot Black Holes of Quantum FFF Theory.
- [100] [viXra:1712.0122](#) The Massless Axion-Higgs Vacuum Rigid String Particle, Even in Micro and Macro Dark Matter Black Hole Nuclei.
- [99] [viXra:1711.0443](#) The Semi Classical Model of Quantum FFF Theory based on Symmetric Transformable Entangled Rigid Strings.
- [98] [viXra:1711.0379](#) The Raspberry Shaped Multiverse, Pulsating Between Big Crunch and Big Bang, Based on Rigid Transformable Massless Axion Higgs Particles.
- [97] [viXra:1711.0327](#) The Einstein Cross Lensing Effect Explained by the Quadruple Dark Matter Formation Process of Edge-on Spiral Galaxies, According to Quantum FFF Theory.
- [96] [viXra:1711.0237](#) Higgs Particle Based SIMPs for Ancient and Future (Stone) Cutting Technology.
- [95] [viXra:1711.0112](#) Higgs Quantum Knots is Dark Matter is Black Holes or: Higgs Dark Matter Black Holes.