

# The Hypergeometrical Universe: Cosmogenesis, Cosmology and Standard Model

Marco Pereira

Rutgers University, Department of Mathematics, The Rutgers University of the State of New Jersey, New Brunswick, NJ, USA

Email:marco.pereira@rutgers.edu

## Abstract:

This paper presents a simple and purely geometrical Grand Unification Theory. Quantum Gravity, Electrostatic and Magnetic interactions are shown in a unified framework. Newton's Gravitational Law, Gauss' Electrostatics Law and Biot-Savart's Electromagnetism Law are derived from first principles.

Gravitational Lensing and Mercury Perihelion Precession are replicated within the theory. Unification symmetry is defined for all the existing forces. This alternative model does not require Strong and Electroweak forces.

A 4D Shock-Wave Hyperspherical topology is proposed for the Universe which together with a Quantum Lagrangian Principle and a Dilator based model for matter result in a quantized stepwise expansion for the whole Universe along a radial direction within a 4D spatial manifold. The Hypergeometrical Standard Model for matter, Universe Topology and a new Law of Gravitation are presented. Newton's and Einstein's Laws of Gravitation and Dynamics, Gauss Law of Electrostatics among others are challenged when HU presents Type 1A Supernova Survey results. HU's SN1a results challenge current Cosmological Standard Model (L-CDM) by challenging its Cosmological Ruler  $d(z)$ . SDSS BOSS dataset is shown to support a new Cosmogenesis theory and HU proposal that we are embedded in a 5D Spacetime. The Big Bang Theory is shown to be challenged by SDSS BOSS dataset. Hyperspherical Acoustic Oscillations are demonstrated in the SDSS BOSS Galaxy density. A New de-Broglie Force is proposed.

**keywords:** Cosmology, Inflation Theory, Cosmogenesis, Relativity, Spacetime

## 1. INTRODUCTION

Grand Unification Theories are the subject of intense research. Among current theories, Superstring, M-Theory, Kaluza-Klein based 5D Gauge Theories have shown diverse degrees of success. All theories try to keep the current conceptual framework of science. Kaluza-Klein<sup>1,2</sup> melded both Electromagnetism and Einstein Gravitational equations in a 5D metric.

Instead of concentrating in keeping the current formalism, this work concentrates on what to say, the conceptual framework of Nature instead. All the common constructs: mass, charge, color, hypercharge are dropped in favor of just dilator positions and dilaton fields, which are local metric modulators and traveling modulations, respectively. There is no need for the concepts of charge or mass. Inertial Mass is modeled as a quantity proportional to the 4D metric displacement volume at precise phases of de-Broglie cycles. These are the footprints of the dilator on our 3D Universe. Charge sign is modeled by dilator phase (sign) on those specific

phases. The mapping is needed to demonstrate that the geometrical framework replicates current scientific knowledge.

As we search for more encompassing theories, they became increasingly complex and speculative. Current best candidate to explain cosmology is the Lambda-CDM (Lambda Cold Dark Matter) based on Friedmann-Lemaitre<sup>3</sup> variation of General Relativity. It is an extension of Einstein's equations to accommodate an expanding (dizzily inflating, accelerating, slowing down, accelerating again) Universe as perceived by Redshifted-Stellar-Candles-mapped distances. To explain such complex dynamics, Lambda-CDM equation below contains 6 parameters, excluding  $H_0$ . HU does that without a single parameter.

$$H(a) \equiv \frac{\dot{a}}{a} = H_0 \sqrt{(\Omega_c + \Omega_b)a^{-3} + \Omega_{rad}a^{-4} + \Omega_k a^{-2} + \Omega_{DE}a^{-3(1+w)}} \quad (1)$$

Current interpretation of type 1A Supernova distances produces an unyielding Universe where linear distances of more than 40 billion light years were observed on a 13.58 billion years old universe. Inflation Theory<sup>5</sup> was created to explain the unexpected observations. HU provides a much simpler view of events. HU proposes that Supernova distances might be overestimated by  $G^{\frac{3}{2}}$ , where G is the Gravitational Constant, due to Chandrasekhar mass G dependence.

Supernova Analysis Section presents HU Cosmology as well as the reproduction of the current view of Inflation and Expansion processes to demonstrate how the possible misreading of distances can lead to the current unexpected conclusions.

In the HU topology section the three spatial coordinates are mapped to a lightspeed expanding hyperspherical hypersurface, thus introducing a new spatial dimension – the radial dimension.

A geometric reason for redshift, the Cosmic Microwave Background<sup>4</sup> and its homogeneity is provided.

HU introduces an absolute frame of reference – the fabric of space (FS), which cannot be measured from within the 3D hypersurface. Local deformation of FS is associated with velocity. Only relative deformational states (relative velocities) are measurable. Local rate of deformation of FS is associated with acceleration and thus with Force. HU also provides the reason why c is the limiting velocity and why there is inertial motion.

A simple Cosmogenesis model is presented on the Cosmogenesis section.

On the Cosmological Coherence section, the consequences of the topology of the Hypergeometrical Universe and the homogeneity proposed in the Fundamental Dilator based model for matter is shown to result in a cosmological coherence, that is, the whole 3D universe expands radially at light speed and in de-Broglie (Compton) steps.

When cosmological coherence is mentioned it is within the framework of absolute time and absolute 4D space (RXYZ or  $\Phi$ XYZ). There is no sense in speaking of synchronous motion

within frameworks containing proper time  $\tau$ . For simplicity, all force derivations are done considering a framework at rest with respect to the Fabric of Space.

A new Quantum Lagrangian Principle (QLP) is created to describe the interaction of dilators and dilatons, Quantum gravity, electrostatics and magnetism laws are derived subsequently as the result of simple constructive interference of five-dimensional spacetime wave overlaid on an expanding hyperspherical universe. In the electrostatics and magnetism derivation, a 4D-mass of a Hydrogen Mass a.m.u. electron or fat electron is used. This means that dilatons (5D spacetime waves driven by coherent metric modulations) are coherently produced by all phases of the dilator coherence.

The 4D-Mass will be fixed to match the 3D-Mass. This will provide us information about the anisotropy of space in the form of an effective Planck Constant for gravitational and electromagnetic dilaton fields. This sheds light on how flush and perpendicular states effect dilaton waves. Space is anisotropic due the existence of our Universe in the traveling hypershell. The tangential “spring constant” is the Planck Constant and “tangential” waves are the de-Broglie waves. Hyper-volumetric waves carry Electromagnetism and Gravitation as well as Light.

Currently, we consider Black Holes to be a gravitationally induced space deformation where not even light can escape. This creates a logical flaw since Black Holes are made up by matter aggregates. Unless Matter is described in terms of space, things are not properly tied down or they might be tied down in a Rube Goldberg manner.

Among Particle Physics strongest challenges was the inability of observing single quarks out of collisional experiments. No matter how strong the collision, single quarks were nowhere to be seen. Strong-Force was introduced to explain the unexpected observation. It would grow to infinity rapidly as the quark separation increases. Quark closeness would bring asymptotic freedom.

New quantum numbers (internal dimensions) were added to accommodate unexpected new particles. Particle Physics observables<sup>5</sup> are both physical (energy, scattering angle, dipole, quadrupole moments, spin) and relational (part of a decay chain reaction or family).

Quarks' existence was inferred from structured scattering, that is, scattering from which one can infer internal structure from the angular distribution of products plus the quantum number based particle taxonomy. What if the observed structure were akin to an excited state of Matter (or space if Matter is described in terms of space deformations)? One can relate to that if one considers atomic collisions. Depending on the energy of the collision, scattering will contain information about excited state orbitals. In analogy to Quarks, one cannot separate the geometric building blocks of those potential excited orbitals. Somehow when considering molecular dynamics collision, nobody proposed the existence of Molecular Quarks to explain products channels. This might seen like a facetious comment, but it is not. This is to emphasize that Quarks is not the only solution to structured scattering.

Due to the success of the Standard Model in explaining scattering events, one doesn't expect HU to start from scratch. One would expect HU to provide a simple map that would link Quarks, Hyperons to structured fluctuations (deformational coherences) of space. HU would provide guidance to modify parts of the Standard Model that are in conflict.

Since HU is derived within a Spatial Stress-Strain paradigm, there is no need for a mechanism from which to derive mass. Conversely, HU provides the mass for the four fundamental particles associated with the Fundamental Dilator (proton, electron, antiproton, positron).

Hypergeometrical Universe Theory model for matter is based on the Fundamental Dilator (FD). This is a coherence between stationary deformation states of the local metric, where "local" was used to emphasize localization.

These coherences do not extend over long distances and have in fact, very small cross-sections. FD excited states are associated with the hyperon family and they have structure or topology.

This might explain "internally" structured scattering results and the inseparability of those "internal" components. This means that HU associates "internal" composition to coherences between excited deformational states of the local metric.

The decaying of these excited states gives rise to the decay chain reactions. From assignment to simple dilator excited states (neutron, pion) and decay reactions one can stepwise build the whole taxonomy. Since particles are assigned to coherences of deformation of space, this fits well with a Black Hole being made of deformed space.

Coherences produce shape-shifting space deformation and thus space deformation waves (dilaton field). The agent of deformation is called a dilator. The resulting waves are the dilaton field.

This is an ongoing line of research. Very early results will be provided to show the potential of the model.

**Supernova analysis provides support for the challenging of Newton's Law of Gravitation and Gauss Law of Electrostatics. It shows that Gravitation and Electromagnetism fall with the number of de Broglie cycles traversed as oppose to the distance.**

A grand unification theory is a far-reaching theory and touches many areas of knowledge. Arguments supporting this kind of theory must be equally scattered. Many arguments will be presented with little discussion when they are immediate conclusions of the topology or simple logic.

## 2. THE HYPERGEOMETRICAL UNIVERSE THEORY

### 2.1 HYPERGEOMETRICAL UNIVERSE TOPOLOGY

The universe is hypothesized to have been created by a four-dimensional explosion, a Big Bang in a Four-Dimensional Spatial Manifold. The evolution of such Big Bang is a lightspeed expanding three-dimensional hypersurface on quantized de-Broglie steps. The steps have length close related to the Compton wavelength associated with the gravitational fundamental dilator (the atomic mass of a hydrogen atom). Table 1 shows 4D-Masses of Gravitational and Electromagnetic Fundamental Dilators. Detailed discussion will follow later.

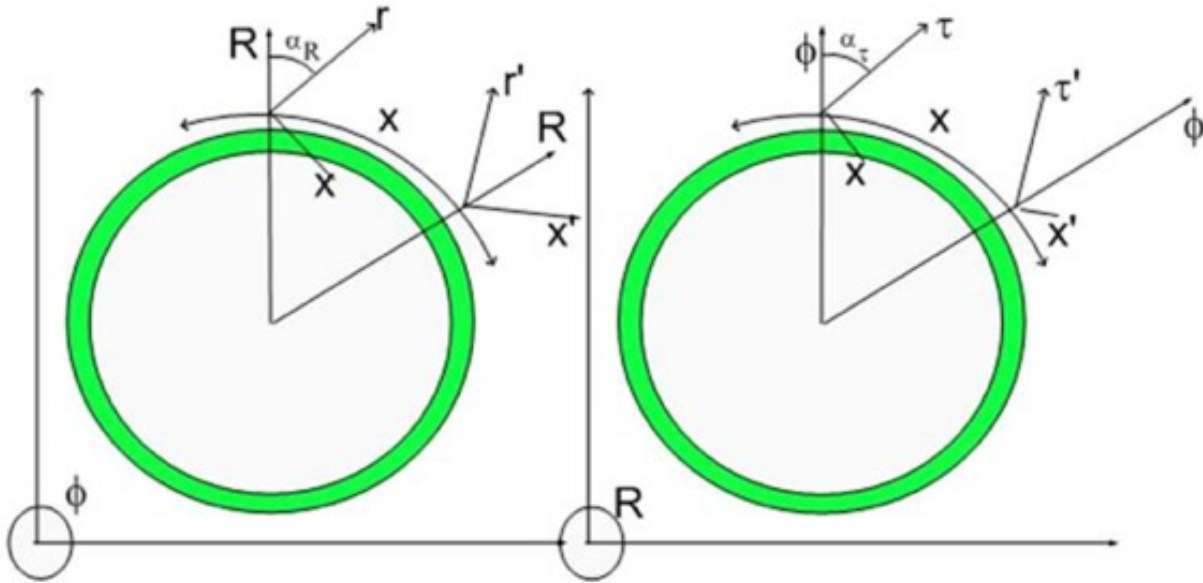

Figure.1 depicts cross sections of the proposed hyperspherical light speed expanding universe. These are the cross-sections  $X\tau$  and  $XR$  for the expanding universe. The universe direction along  $X$  is represented by the band.  $X$  (or  $Y$  or  $Z$ ) is displayed along the perimeter of the circle. The circle radius is equal to the age of the universe times the speed of light. Also, shown in the diagram are  $\Phi$  (cosmological time), proper time  $\tau$ , radial direction  $R$ , proper radial projection  $r$ , the Cosmological Angle  $\alpha$  between two reference frames  $XYZ\tau$  and  $X'Y'Z'\tau'$ , the local torsion angles  $\alpha_r$  and  $\alpha_R$ . By choosing a local metric for  $xyz\tau$  Minkowskian and having a Lorentz transformation to relate  $XYZ\tau$  and  $X'Y'Z'\tau'$  reference frames, one can assure that the theory obeys Strict Relativity.<sup>6</sup>

Table 1. Fundamental Dilators

Dilator	4D-Mass (a.m.u.):
Electromagnetic Fundamental Dilator(EFD)	HydrogenMass
Gravitational Fundamental Dilator(GFD)	HydrogenMass x 2

### 2.1.1 DEFINITIONS

1. Cosmological time  $\Phi$  represents an absolute time frame, as envisioned by Newton and Mach - it is a fifth dimension in the Hypergeometrical Universe Model. It times the expansion of the Universe.
2. Proper time  $\tau, \tau'$  are projections of the Cosmological Time  $\Phi$  (which is always along a radial direction) on the respective reference frames.
3. Fabric of Space (FS) is the Lightspeed traveling locus where our 3D Universe exists. This is a 3D hypersurface of a shockwave within a 4D spatial manifold. Anything at rest with respect to the Fabric of Space would just travel radially at the speed of light. At the Big Bang, all dilators would be initially traveling at the speed of light, not only radially but also tangentially in all directions. When the Universe is a point, there is no difference between tangential and radial directions. As the Universe aged, dilators would, on average, reach equilibrium and a low (zero) velocity with respect to FS.
4. The radial direction is a preferential direction in 4D space. It is the radial expansion direction. This direction doubles as a direction on 4D Space and a projection of the cosmological time, since they are related by the expansion speed (lightspeed).
5.  $\alpha_r$  and  $\alpha_t$  represent both a direction of propagation and a deformation of the local fabric of space. Since these angles point to direction of propagation, a local deformation of the fabric of space maps directly to a state of motion. Motion is the result of the relaxation process of the local FS (Hypergeometrical Universe interpretation of **Newton's first law**) as the FS expands.
6. XYZR is modeled as a Cartesian space
7. xyzT (proper reference frame) is modeled as a hyperbolic space and thus consistent with Strict Relativity<sup>6-8</sup> if one considers that the Lorentz transformation is a rotation on an imaginary angle equal to  $\text{atan}(v/c)$ .

### 2.1.2 UNIVERSE EXPANSION AND THE HUBBLE CONSTANT

Edwin Hubble<sup>9</sup> discovered that Stars and Galaxies are receding from us at speeds that increase linearly with distance.

$$V = H_0 L \quad (2)$$

where V is the receding velocity,  $H_0$  is the Hubble constant, L is the linear distance. The associated frequency shift was modeled as a velocity-dependent Doppler shift by:

$$\frac{v}{c} = \sqrt{\frac{(1+z)^2 - 1}{(1+z)^2 + 1}} = \frac{H_0}{c} d * Hubble(z) \quad (3)$$

The spectral shift is represented by a factor z:

$$z = \frac{\Delta\lambda_{obs}}{\lambda_0} \quad (4)$$

$$1+z = \frac{\lambda_{obs}}{\lambda_0} \quad (5)$$

From the proposed topology shown in Fig.1 one can easily ascertain the Hypergeometrical Universe model for the Hubble Constant:

$$H_0 = \frac{c}{R_0} \tag{6}$$

where  $c$  is the speed of light and  $R_0$  is the 4D Radius of the Universe (age of the Universe time the speed of light). For  $H_0 = 72 \text{ km/s/Mpc}$ :

$$R_0 = \frac{c}{H_0} = 13.58 \text{ billion - light - years} \tag{7}$$

Yielding the age of the Universe as 13.58 billion years.

### 2.1.3 HYPERGEOMETRICAL UNIVERSE - VIEWING THE PAST

The proposed topology is of a light-speed expanding hyperspherical hypersurface to represent the spatial coordinates of our Universe. This means that the 3D Universe is a moving inertial frame with very specific topology, curvature (there are three curvatures one spatial and others spacetime related).

The absolute speed of light for short distances becomes  $\sqrt{2}c$ . This doesn't affect any experimental measurements since they are done within the confines of the hypersurface and within very small Cosmological Angles. A Cosmological Angle is represented in Figure 2 as alpha.

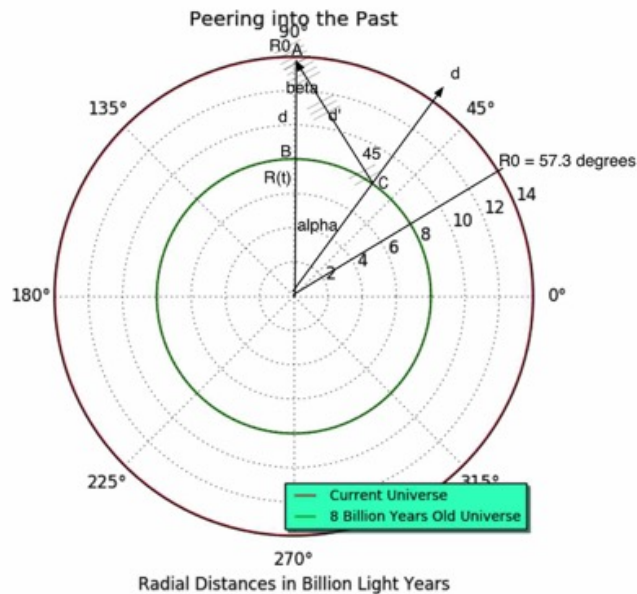

Figure 2. This shows how one interprets peering into the past within the Hypergeometrical Universe Theory. We indicated two epochs - the current and the one for the 8 billion years old Universe. Light emission angle with the radial line is always 45 degrees. K-vector direction for the light that we detect is

always a line-of-sight vector. The mapping of the Universe Lifeline to Cosmological Angle Alpha is given by  $[R_0, 0] \rightarrow [0, \pi/4]$ .

Simple trigonometry yields:

$$\frac{\sin(\alpha)}{d'} = \frac{\sin(\frac{3}{4}\pi)}{R_0} = \frac{\sin(\frac{\pi}{4} - \alpha)}{R(t)} \quad (8)$$

### 2.3.1 DISTANCE VERSUS NUMBER OF CYCLES

HU prescribes that the dilaton field intensity (thus the light intensity) to decay with the inverse the number of cycles and not with plain distance. Below are the dilaton field equations for a probe dilator at position  $x_0$  and a large mass or amount of charge (N dilators) at position R. The full dilaton field is given by:

$$\Psi_1(x, x_0) = \frac{\cos(k_1 \cdot (x - x_0))}{(1 + f(k_1 \cdot (x - x_0)))} \quad (9)$$

$$\Psi_2(x, x_0) = \frac{N \cos(k_2 \cdot x)}{(1 + f(k_2 \cdot (R - x)))} \quad (10)$$

$$\Psi_{Total}(x, x_0) = \Psi_1(x, x_0) + \Psi_2(x, x_0) \quad (11)$$

Function f is equal to ONE for most space. The only requirement is that

$$\left. \frac{df(x)}{dx} \right|_{x=x_0} = 0 \quad (12)$$

that is, the dilaton field is created symmetrically with respect to  $x_0$ .

From these simple equations, we will derive Natural Laws, including Gravitation and Electromagnetism. Light is modeled as a spatial modulation of the dilaton field due to the transition dipole oscillator created at the moment of light emission.

Not unlike Maxwell equations, the dilaton field (Electromagnetic Field) polarizes the next hypersphere (Induced Polarization) which then creates new Electromagnetic field. This means that the radial velocity of light is fixed by the requirement of Maxwell equations and the underlying Physics.

**All points in an inner hypersphere are at the same “effective distance” as the point  $[0, R(t)]$ . Line-of-sight constraint selects one point at each hypersphere for each direction  $x$**



### 2.3.2 ADJUSTABLE DILATON FIELD VELOCITY WITH ANGLE

The dilaton field we sense is created at each de Broglie step by dilators. The Radial Velocity of the dilaton field is controlled by the radial velocity of the Polarizable Media. The polarizable media is the 3D Universe and thus the Radial Velocity of Light is always  $c$ .

The question is what happens to the tangential velocity as a photon propagates through the line-of-sight path shown in Fig. 2. That line-of-sight path shows that as the photon comes closer and closer to the observers perched on position A, the projection of the Electromagnetic waves onto our local hyperplane grows larger and larger. That shows that wavelength changes as the photons travel.

The time dimension of what is happening on that traveling photon is kept along the radial direction all the time. That means that, we would be seeing the dynamical events as if they were local. The only difference would be that all light would be redshifted.

**This is the preliminary conclusion. It should be confirmed or disavowed by measurements of power spectra of distant Quasars. According to HU, the power spectra (Fourier transform of intensity light fluctuations) of Quasars should be independent upon distance.**

### 2.3.3 REDSHIFTING OF LIGHT WITH TRAVEL.

This also means that **the absolute speed of light for photons coming from large distances accelerates as they come close to us.** The reason is the increasing tilt of the Fabric of Space, easily understandable from just looking at different hyperspheres. Notice that we are considering that light was emitted and detected on relaxed FS regions. Their local proper time flows at the different rates according to the Cosmological angle  $\alpha$ . **The imprinted photon will carry that information in a way that erases the time flow difference.**

Since we consider at short distances that the speed of light is always  $c$ , then the correct distance to be used is given by equation (13):

$$\frac{d_{HU\_epoch}}{R_0} = \frac{R_0 - R(t)}{R_0} = 1 - \sqrt{2} * \sin\left(\frac{\pi}{4} - \alpha\right) = 1 - \cos(\alpha) + \sin(\alpha) \quad (13)$$

This is the distance that maps to the expected distance of the current view, that is, if the speed of light were  $c$ , this would be the distance traversed at the speed of light during the time between the Supernova explosion and its observation. Considering planar waves (see Fig 2), the relationship between an observed wavelength and the 4D wavelength is such that for  $\alpha=0$ :

$$\lambda_{Obs} = \lambda_0 = \sqrt{2}\lambda_{4D} \quad (14)$$

where 4D is the wavelength traveling within the 4D spatial manifold. For any other cosmological angle  $\alpha$ , the relationship is given by:

$$\frac{\lambda_{4D}}{\lambda_{Obs}} = \sin\left(\frac{\pi}{4} - \alpha\right) \quad (15)$$

Multiplying both sides by  $\sqrt{2}$

$$\frac{\sqrt{2}\lambda_{4D}}{\lambda_{Obs}} = \frac{\lambda_0}{\lambda_{Obs}} = \frac{1}{(1+z)} = \sqrt{2}\sin\left(\frac{\pi}{4} - \alpha\right) \quad (16)$$

Hence:

$$\alpha = \frac{\pi}{4} - \arcsin\left(\frac{1}{\sqrt{2}(1+z)}\right) \quad (17)$$

This is the Hypergeometrical Universe relationship between d and z, were d is projected on the current epoch. For prior epochs, one should use the sine relationship to derive:

$$d' = \sqrt{2}R_0\sin(\alpha) = \sqrt{2}R_0\sin\left(\frac{\pi}{4} - \arcsin\left(\frac{1}{\sqrt{2}(1+z)}\right)\right) \quad (18)$$

This actual distance is irrelevant for light intensity decay.

A 1<sup>st</sup> Quadrant Supernova presenting a redshift z, travels at

$$\frac{v}{c} = 1 - \frac{4}{\pi} \arcsin\left(\frac{1}{\sqrt{2}(1+z)}\right) \quad (19)$$

Is located at angle  $\alpha$

$$\alpha = \frac{\pi}{4} - \arcsin\left(\frac{1}{\sqrt{2}(1+z)}\right) \quad (20)$$

and at an equivalent distance on our current 3D Hypersphere given by:

$$d = d_{HU\_epoch} = R_0(1 - \cos(\alpha) + \sin(\alpha)) \quad (21)$$

Notice that this is a different relationship between d and z than the one described on equation (2).

$$R_0 = \frac{c}{H_0} = 13.58Gly \quad (22)$$

The numerical value of  $R_0$  is only used to scale Supernova Distances from the Survey. A normalized  $R_0$  is used for the trigonometric relationships.

This derivation used the Line-Of-Sight optical path. As a result, the whole visible Universe  $[0,1\text{radian}]$  is mapped to a Cosmological Angles in  $[0,\pi/4]$ .

### 2.3.4 TIME ABERRATION

Even though light will always travel through the 4D spatial manifold, the requirement of always observing light that is emitted at 45 degrees imply that we are considering just the focus plane in

our measurements. Within a given angular volume, observations can come from slight different epochs (like color aberration). This is exactly what would happen when you look at very large cosmological angles and observe a larger error on the determination of the redshift parameter  $z$ .

## 2.1.4 SUPERNOVA DISTANCE ANALYSIS

Current analysis indicates that many of the Supernovae explosions take place at distances larger than the maximum distance traveled during the Universe lifetime (circa 13.58 Billion Years). This paradoxical result is the motivation for Inflation Theory<sup>10</sup>, the proposition of Dark Energy (to support the expansion) and Dark Matter to counterbalance it.

This Supernova Survey is composed of observations of Type 1A Supernova explosions. Type 1A Supernova explosions are thought to have as precursors a binary system of White Dwarfs or White Dwarf-Star. The justification for the consistency in Luminosity is that the White Dwarf steals material from the companion until it reaches the Chandrasekhar mass<sup>11</sup>. At that point, the electron Fermionic repulsion cannot keep the Dwarf from collapsing any longer. Its collapse ignites a chain reaction that consumes Carbon and Oxygen with the final product being <sup>56</sup>Ni.

Now let's prove the main assertion that distances might be overestimated. We will be based our derivation on Arnett's work<sup>12</sup>: Here we will study the effect of a distinct value of  $G$  would have on the Light Curve. The Luminosity of a Supernova is given by Arnett's eq.39:

$$L(1,t) = L(1,0)\phi(t) \quad (23)$$

where

$$L(1,0) = K_0 \left[ \frac{R(0)}{10^{14} \text{ cm}} \right] \left[ \frac{E_{th}(0)}{10^{51} \text{ ergs}} \right] \left( \left[ \frac{0.4 \text{ cm}^2 \text{ g}^{-1}}{\kappa} \right] \right) \left[ \frac{1M_{\odot}}{M} \right] \quad (24)$$

$$E_{th}(0) = \int_0^{R(0)} aT^4 4\pi r^2 dr \quad (25)$$

Chandrasekhar Radius has the following  $G$  dependence:

$$R^{Epoch}(0) = \left( \frac{G_0}{G_{Epoch}} \right)^{\frac{1}{2}} R(0) = \vartheta R(0) \quad (26)$$

$$\vartheta = \left( \frac{G_0}{G_{Epoch}} \right)^{\frac{1}{2}} \quad (27)$$

If you model a Star as to be emitting Blackbody radiation, its luminosity will be given by:

$$L = 4\pi R^2 \sigma T_s^4 \quad (28)$$

Relating two stars in different epochs facing different  $G_s$ , same temperature  $T_{Solar}$ , we obtain:

$$\frac{L_{Solar}^{Epoch}}{L_{Solar}} = \left( \frac{R_0^{Epoch}}{R_0} \right)^2 \left( \frac{T_{Solar}^{Epoch}}{T_{Solar}} \right)^4 \quad (29)$$

### 2.4.1 LOW RADIATION PRESSURE LIMIT

Simple modeling of the Sun's luminosity yields<sup>13</sup>:

$$L \propto G^4 M^{3.33} \quad (30)$$

Considering the ratio between luminosities to scale with Mass we can derive the epoch dependent Solar Mass:

$$\left(\frac{G^{Epoch}}{G_0}\right)^4 \left(\frac{M_\odot^{Epoch}}{M_\odot}\right)^{3.33} = \frac{L^{Epoch}}{L_{Solar}} = \left(\frac{R_0^{Epoch}}{R_0}\right)^2 \left(\frac{T_{Solar}^{Epoch}}{T_{Solar}}\right)^4 = \left(\frac{R_0^{Epoch}}{R_0}\right)^2 = \vartheta^2 \quad (31)$$

This Solar mass is the mass required to yield the same surface temperature given that the radius shrank accordingly to the White Dwarf Chandrasekhar radius. The approximation is that Luminosity scales with Star mass.

$$M_\odot = \vartheta^{-3} M_\odot^{Epoch} \quad (32)$$

Substituting equations 32,26 into equations 24-25:

$$L(1,0) = K_0 \left[ \frac{\vartheta^{-1} R^{Epoch}(0)}{10^{14} \text{ cm}} \right] \left[ \frac{\vartheta^{-3} E_{th}^{Epoch}(0)}{10^{51} \text{ ergs}} \right] \left( \left[ \frac{0.4 \text{ cm}^2 \text{ g}^{-1}}{\kappa} \right] \right) \left[ \frac{1 \vartheta^{-3} M_\odot^{Epoch}}{M} \right] \quad (33)$$

$$L(1,0) = \vartheta^{-7} K_0 \left[ \frac{R^{Epoch}(0)}{10^{14} \text{ cm}} \right] \left[ \frac{E_{th}^{Epoch}(0)}{10^{51} \text{ ergs}} \right] \left( \left[ \frac{0.4 \text{ cm}^2 \text{ g}^{-1}}{\kappa} \right] \right) \left[ \frac{1 M_\odot^{Epoch}}{M} \right] \quad (34)$$

Since

$$L^{Epoch}(1,0) = K_0 \left[ \frac{R^{Epoch}(0)}{10^{14} \text{ cm}} \right] \left[ \frac{E_{th}^{Epoch}(0)}{10^{51} \text{ ergs}} \right] \left( \left[ \frac{0.4 \text{ cm}^2 \text{ g}^{-1}}{\kappa} \right] \right) \left[ \frac{1 M_\odot^{Epoch}}{M} \right] \quad (35)$$

We obtain the following relationship between Absolute Peak Luminosities now and in earlier epochs:

$$L^{Epoch}(1,0) = \vartheta^7 L(1,0) = \left(\frac{G_0}{G_{Epoch}}\right)^{3.5} L(1,0) = \left(\frac{R_{Epoch}}{R_0}\right)^{3.5} L(1,0) \quad (36)$$

### 2.4.2 HIGH RADIATION PRESSURE LIMIT

For larger stars or during Supernova detonation, the radiation pressure is larger than the gas pressure in the radiation zone. Plugging in the radiation pressure, instead of the ideal gas pressure used above, yields:

$$L \propto M \quad (37)$$

Considering the ratio between luminosities to scale with Mass we can derive the epoch dependent Solar Mass:

$$\left(\frac{M_\odot^{Epoch}}{M_\odot}\right) = \frac{L^{Epoch}}{L_{Solar}} = \left(\frac{R_0^{Epoch}}{R_0}\right)^2 \left(\frac{T_{Solar}^{Epoch}}{T_{Solar}}\right)^4 = \left(\frac{R_0^{Epoch}}{R_0}\right)^2 = \vartheta^2 \quad (38)$$

This Solar mass is the mass required to yield the same surface temperature given that the radius shrank accordingly to the White Dwarf Chandrasekhar radius. The approximation is that Luminosity scales with Star mass.

$$M_{\odot} = \vartheta^{-2} M_{\odot}^{Epoch} \quad (39)$$

Substituting equations 39,26 into equations 24-25:

$$L(1,0) = K_0 \left[ \frac{\vartheta^{-1} R^{Epoch}(0)}{10^{14} \text{ cm}} \right] \left[ \frac{\vartheta^{-3} E_{th}^{Epoch}(0)}{10^{51} \text{ ergs}} \right] \left( \left[ \frac{0.4 \text{ cm}^2 \text{ g}^{-1}}{\kappa} \right] \right) \left[ \frac{1 \vartheta^{-2} M_{\odot}^{Epoch}}{M} \right] \quad (40)$$

$$L(1,0) = \vartheta^{-6} K_0 \left[ \frac{R^{Epoch}(0)}{10^{14} \text{ cm}} \right] \left[ \frac{E_{th}^{Epoch}(0)}{10^{51} \text{ ergs}} \right] \left( \left[ \frac{0.4 \text{ cm}^2 \text{ g}^{-1}}{\kappa} \right] \right) \left[ \frac{1 M_{\odot}^{Epoch}}{M} \right] \quad (41)$$

Since

$$L^{Epoch}(1,0) = K_0 \left[ \frac{R^{Epoch}(0)}{10^{14} \text{ cm}} \right] \left[ \frac{E_{th}^{Epoch}(0)}{10^{51} \text{ ergs}} \right] \left( \left[ \frac{0.4 \text{ cm}^2 \text{ g}^{-1}}{\kappa} \right] \right) \left[ \frac{1 M_{\odot}^{Epoch}}{M} \right] \quad (42)$$

We obtain the following relationship between Absolute Peak Luminosities now and in earlier epochs:

$$L^{Epoch}(1,0) = \vartheta^6 L(1,0) = \left( \frac{G_0}{G_{Epoch}} \right)^3 L(1,0) = \left( \frac{R_{Epoch}}{R_0} \right)^3 L(1,0) \quad (43)$$

This means that prior epochs had dimer Absolute Peak Luminosity and thus were overestimated by current Cosmology.

This means that Supernova Distances would be overestimated by  $\left( \frac{R_{Epoch}}{R_0} \right)^{1.75}$  or  $\left( \frac{R_{Epoch}}{R_0} \right)^{1.5}$  depending on the model one chooses for how the Mass of a Star would depend upon G :

$$d^{Epoch}(z) = \vartheta^3 d(z) = \left( \frac{R_{Epoch}}{R_0} \right)^{1.5} d(z) \quad (44)$$

For the rest of the article we will use  $R_0 = G_0 = 1$ .

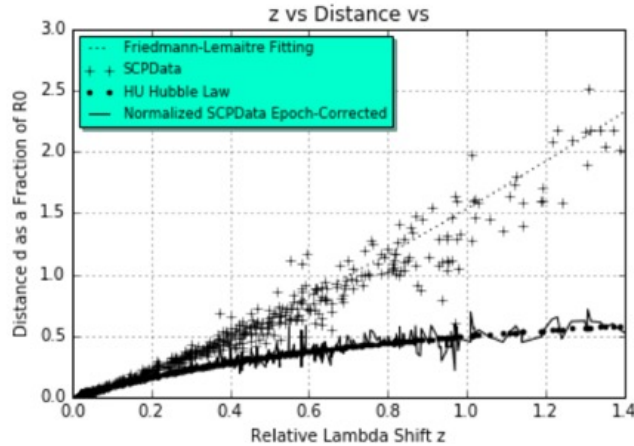
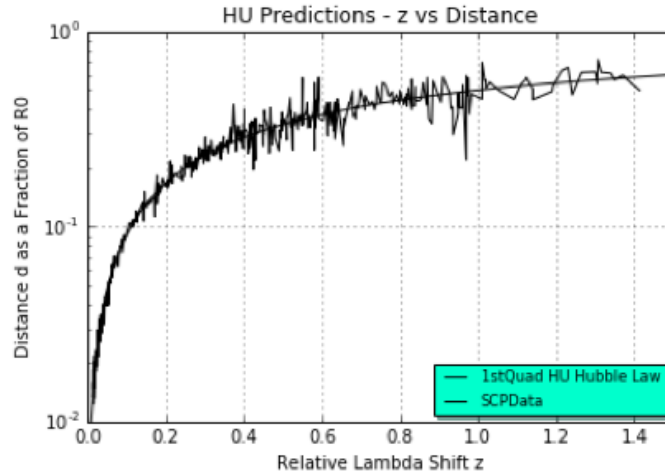

Figure 3. Here are depicted the Friedmann-Lemaitre Hubble Law (Planck15 on astropy<sup>14</sup>) the raw astronomic data (SCPUnion2.1) normalized using the full 4D radius of the Universe (13.58 Bly). Also represented are the raw data scaled-down by the  $G(d)^{-3/2}$  scaling factor and the HU predictions for the first quadrant. The Friedmann-Lemaitre curve used a 14.43 Gly Universe, so there is a slight misrepresentation, which is irrelevant in the context of this article, since the observational data points are being proposed to be scaled down. The data we will use comes from the Supernova Broad Survey Union 2.1 dataset<sup>15</sup>

### 2.4.3 HU PREDICTIONS - GOODNESS OF FITTING



Figures 4 presents the raw data, HU, scaled raw data and Friedmann-Lemaitre results. The main point of this plot is how unexpected the raw data is. It portraits explosions as far as 2.5 times the maximum possible distance traversed by light.

Friedmann-Lemaitre fitting to different epochs provided different parameters and thus different physics. Notice HU scaled-down data consistent with the epoch-dependent Supernovas paradigm.

Below are chi-squared results for both modulus-distance and normalized distance observed-values and predicted-values.

Power-Divergence chi-square for **modulus-distance** (Statistic=1.33, pvalue=1.0)

Power-Divergence chi-square for **normalized-distance** (Statistic=2.64, pvalue=1.0)

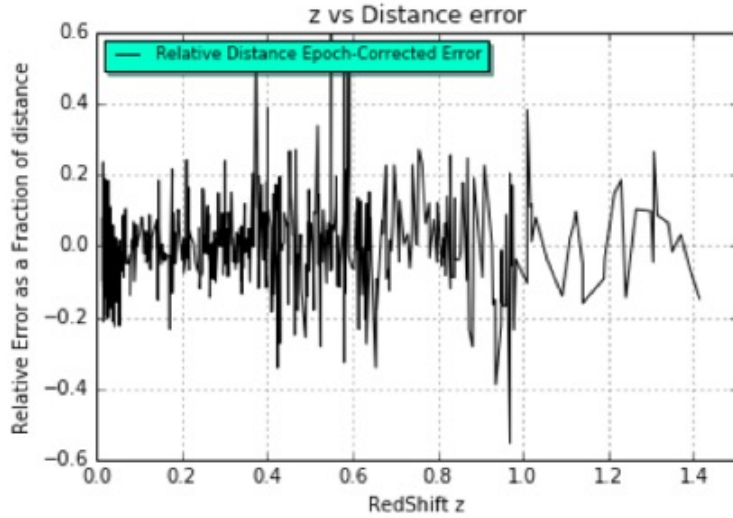

Figure 5. Relative Distance Error for epoch corrected survey distances

The topological view of the Supernova explosions is presented in Fig. 6:

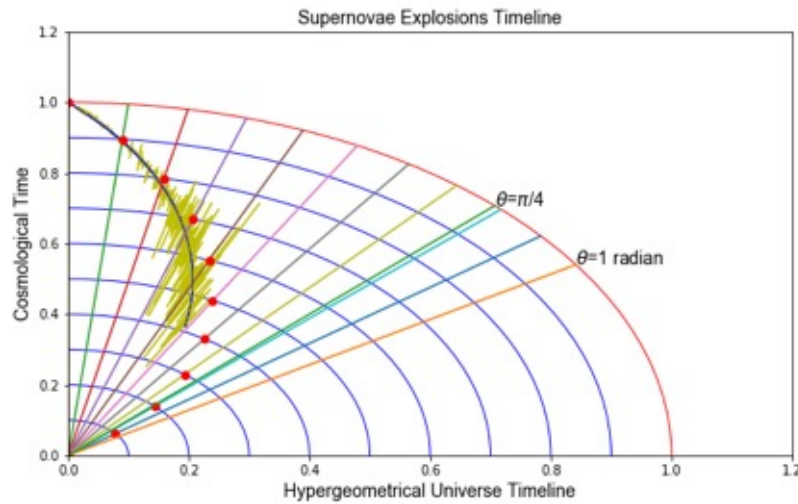

Figure 6. HU view of Supernova Explosions showcasing prior epochs as smaller hyperspheres. The red-dot correspond to a hypothesized recoilless (photon momentum amplitude is conserved). Under closer analysis this path was rejected for the transportation of redshifted Supernova photons. Yellow lines show the observed Supernova Data. Smooth line is the HU Predictions.

## 2.4 4D PERCEIVED ACCELERATION

HU predictions can be used to explain the current view of the Cosmos, including the perceived acceleration, initial Inflation. The HU distance is given by:

$$D(t) = \frac{R_0 - R(t)}{R_0} = 1 - a(t) \quad (45)$$

where

$$a(t) = \frac{R(t)}{R_0} = \frac{ct}{R_0} \quad (46)$$

That L-CDM distance is overestimated by:

$$D_{obs}(t) = 1 - a_{obs}(t) = D(t) \left( \frac{R_0}{R(t)} \right)^{3/2} = (1 - a(t)) a(t)^{-3/2} = a(t)^{-3/2} - a(t)^{-1/2} \quad (47)$$

Taking derivatives:

$$\frac{dD_{obs}(t)}{dt} = \left( -\frac{3}{2} a(t)^{-5/2} + \frac{1}{2} a(t)^{-3/2} \right) \dot{a}(t) \quad (48)$$

$$\frac{d^2 D_{obs}(t)}{dt^2} = \left( \frac{15}{4} a(t)^{-7/2} - \frac{3}{4} a(t)^{-5/2} \right) \dot{a}(t)^2 \quad (49)$$

Since

$$\frac{da(t)}{dt} = \frac{c}{R_0} \quad (50)$$

and

$$\frac{d^2 a(t)}{dt^2} = 0 \quad (51)$$

The resulting “observed” acceleration is given by:

$$\frac{d^2 a_{obs}(t)}{dt^2} = \frac{3c^2}{4R_0} a(t)^{-7/2} (5 - a(t)) \quad (52)$$

Below is the view of the perceived acceleration resulting from possible misreading of Supernovae distances:

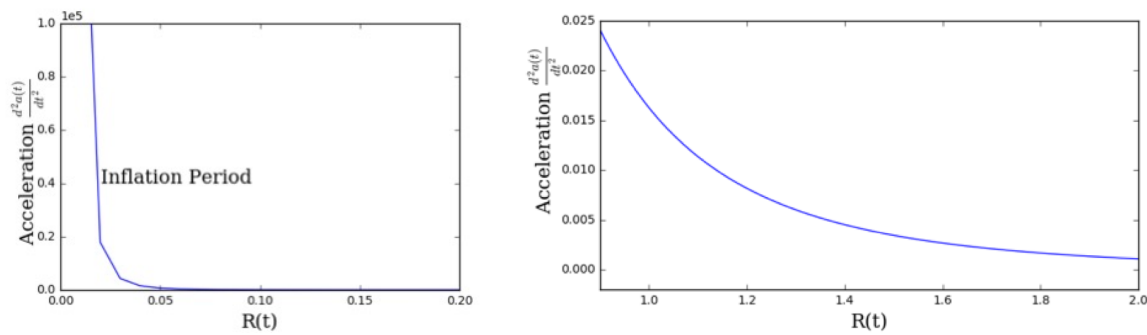

Figure 7. Perceived Universe acceleration in units of  $R_0/(\text{Billion Years})^2$ . Left panel: Inflation Period. Right Panel: Current Acceleration=  $1.6\%/(\text{Billion Years})^2$ .



If we use units of  $\frac{R_0}{(\text{BillionYears})^2}$  instead:

$$\frac{d^2 a_{obs}(t)}{dt^2} = \frac{3}{4(13.58)^2} a(t)^{-7/2} (5 - a(t)) = 0.4\% * a(t)^{-7/2} (5 - a(t)) \quad (53)$$

This means that for current times ( $a(T)=1$ ), the Universe has been perceived as accelerating at  $\frac{1.6\%}{(\text{BillionYears})^2}$ .

Notice that the acceleration becomes negative at  $R(t)=5R_0$ . All these results are likely to be artifacts of the overestimation of Supernovae distances.

### 2.1.5 SIMPLE COSMOGENESIS

HU proposes that the Universe came into being and was placed in motion by the Big Pop<sup>16</sup>. The Big Pop is the partial recombination of the 4D Initial Fluctuation.

In the preamble to the **Big Pop**, we propose that the Universe is uncertain, as in the Uncertainty Principle. That expresses itself during Cosmogenesis, in metric fluctuations on both dimensionality and density.

The model states that the Universe would oscillated in dimensionality and fluctuation size. For instance, fluctuations in a Zero dimensional space are just numbers of opposite sign. They will always add up to Zero. Fluctuations in a One-Dimensional Space would correspond to vectors along a line, also of opposing signs. Fluctuations in two dimensions would be the two dimensional metric deformations. An area would contain a contraction of space surrounded by a region where space would be dilated. The total effect is null, that is, if one were to measure the distance between two points outside that region, in opposing directions across the center of the fluctuation, the distance would had remained the same, undisturbed by the Fluctuation.

Similarly, a 3D space fluctuation would be a 2s-orbital-like spherical metric fluctuation. Our Universe could, in principle, be borne out of a 3D Space Fluctuation. The problem with that is that, none of the Laws of Physics would work there. The reasons for that will become clear when the Fundamental Dilator and the Quantum Lagrangian Principle are presented.

Finally, a 4D Fluctuation would be a 2s-orbital-like hyperspherical metric fluctuation. One should think about the 4D hyperspherical metric fluctuation as composed of layers, being the outermost layer a contraction. Once created, immediately, it started recombining. Layer after layer, within the hypersphere, recombined to relax space (make it flat again). That kept going until the hypersphere inside only contained one layer associated with dilation and the outermost layer (us, the Universe).

At that point, HU hypothesize that the outermost layers started a decay process, moving from a smooth metric deformation to a fragmented one. HU associated that state to the one inside a Black Hole. HU will later indicate that the density is such as to have half-hydrogen atom inside

each 0.19 femtometer side cell. That yields a density of  $2.37E20 \text{ Kg}/M^3$ . Once fragmented, the outmost layer could not recombine with the left over inside layer. Since that layer was a dilation, that set the Universe in motion at the speed of light and did that without releasing a single photon or heating up anything. That is the Big Pop. The Universe was born in the Blackholium phase – The phase with the Highest Entropy and the Highest Potential energy (FDs paired up as Neutrons).

Knowing the current mass density and the Blackholium density allow us to calculate the 4D radius of the Initial Fluctuation as being 146 light-seconds. So, the Universe was born as a 146 light-seconds radius cold Black Hole.

Once the Universe was placed in motion, the density decrease until it reached the Neutronium phase, where the density of the Universe becomes  $7.7E18 \text{ Kg}/M^3$  and equals the density of a Neutron Star. The radius would be 457 light-seconds. About that time, neutron started to become free and decay. Their decay released energy which feedback density oscillations (Neutronium Acoustic Oscillations or NAO).

During the course of 3012 years, NAO increased in intensity as larger and larger fractions of the Neutronium converted into Baryons (Electron, Proton and Antineutrino). That is the Baryonium Phase of the Universe.

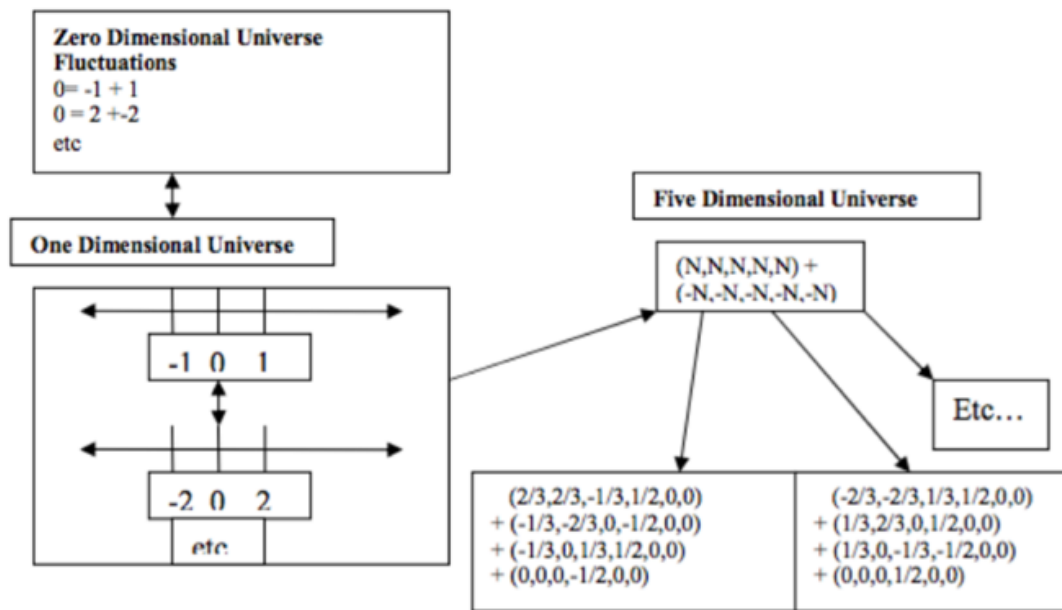

Figure 8. This picture displays the mapping different phases of the Universe coming into existence to Mathematical Constructs. Top-left displays the Zero-Dimensional Universe (just numbers, adding always to zero), following by the Unidimensional Space (just equal size opposing vectors along a line) and eventually to our 5D Spacetime Universe. This is the pictorial display of equilibrium at the incipient Universe (prior to irreversible dimensional phase transition) and the Big Pop irreversible transition.

That Banging made impressions on the initial matter distribution and can be seen in the SDSS (Sloan Digital Sky Survey).

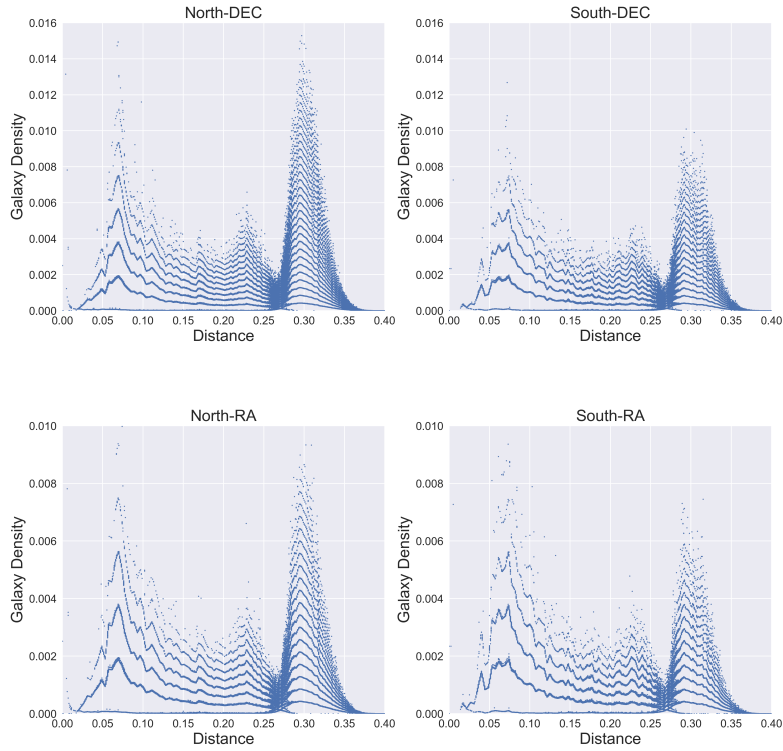

Figure 9. This presents the cross-sections of SDSS map along distance and Declination. Once the data was aggregated onto those two coordinates, we dropped the angular dimension and plotted density versus distance from us. It is cross-section of the HU Universe Map showing the galaxy densities along distances. This data was pre-aggregated along RA, before plotted disregarding DEC.

Figure 9 presents cross-sections of the Universe along the two angular dimensions (Declination and Right Ascension) for both North and South SDSS BOSS datasets.

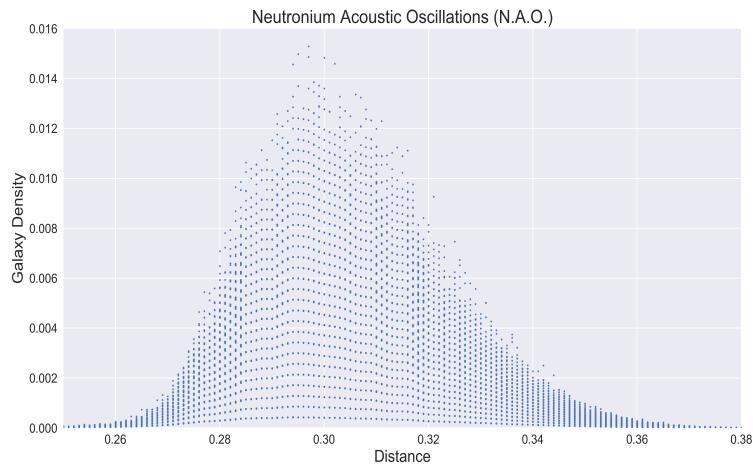

Figure 10. It shows details of NAO depositions onto the Universe. As stationary density waves slosh around in the Universe, regions of the Universe were increased in density at each resonate.

Figure 10 shows the close-up of the NAO ridge at  $0.3 R_0$ . One can see at least 36 Bangs. The usage of the word Bang emphasizes that HU rejects the Big Bang as the source of the Universe and provides the evidence in the form of NAOs (Neutronium Acoustic Oscillations). Calculations are available at the github repository<sup>17</sup>.

As density on the Neutronium Phase decreases, the effect of NAO is to seed Black Holes. Due to the hyperspherical symmetry, Gravitational field only become relevant when density decreases. The ability of NAO to seed Black Holes is inversely proportional to the Neutronium density until the total its decay into free neutrons.

The plot is the aggregation of SDSS (Sloan Digital Sky Survey), on distance (named alpha) and Declination. Later, Declination is dropped and the plot is created. Surprisingly, the effect of acoustic waves was to incrementally aggregate the seeds of the galaxies and galaxy cluster. The level of aggregation increased linearly with each resonating of the acoustic waves. That happened while the Universe was expanding at the speed of light. Simple calculation indicated that the 36 Bangs took 3012 years to happen.

In addition to these visible galaxy clusters, one would expect also Fibonacci clusters, although they should be rarer and thus more difficult to spot.

### 2.1.5.1 HOW MUCH ENERGY WAS RELEASED DURING THE MANY-BANGS?

During the 3012 years, there was at least 36 Bangs in a crescendo, releasing the energy of the Neutronium. Since the Neutronium was a 457 light-seconds Neutron star, one can easily calculate the number of neutrons and the energy released when they decay. That energy was equivalent to  $10^{22}$  Supernovae.

NAO 0.3 ridge can be observed on the 3D xyz Map<sup>18</sup> while the Many-Bangs can be seen in the 3D RA\_Dec Map<sup>19</sup>.

### 2.1.5.2 NON-CRITICAL ANTHROPIC ARGUMENT

Preceding the Big Pop there were dimensional transitions. Once the Big Pop placed the Universe in motion, the Laws of Physics went into action. The Many-Banging, provided the dilator intensity needed to synchronize spinning through the Quantum Lagrangian Principle. Any dilator traveling faster or slower than the speed of light would be left behind or too far ahead of us to have any effect on our Universe.

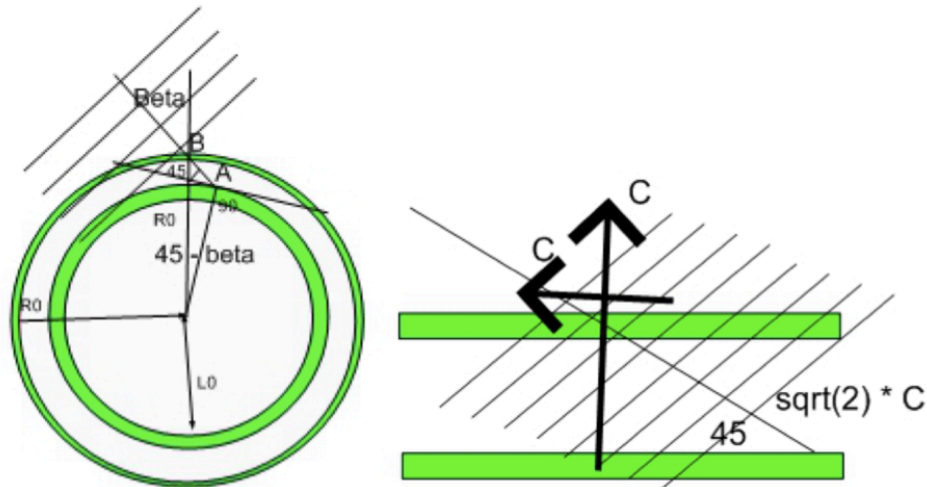

Figure 11. Time zero boundary conditions are shown. When the 4D macroscopic fluctuation arises and decays, a myriad dilators are created (matter and antimatter). The distribution of matter and antimatter follows a  $2s$  hyperspherical orbital distribution (4D space). Recombination occurs at the edge between matter and antimatter. This initial recombination is what propels the whole Universe outwards traveling at the speed of light. Here is where spin quantization and tunneling frequencies plays the most important role on the Universe. From our discussion of dilators and the stroboscopic Universe interaction can only exist at specific angles, so the acceleration happens coherently even if the interaction takes place on several dilator cycles.

This is a Non-Critical Anthropic argument, that is, it doesn't depend critically on anything. The only thing it depends is that there is a 4D spatial manifold and the interaction happens through 4D metric waves governed by a No-Work-by-Dilators Principle (Quantum Lagrangian Principle or Lazy Dilators Principle or Space Deformation Quantization). **Spinning phase was also synced by the same logic.**

### 2.1.5.3 WHAT IS THE ESSENCE OF A UNIVERSE?

What makes a Universe is interaction! All laws of Physics depend upon that. To interact, particles should be within the same hypersphere and traveling at the speed of light ( $c$ ). That condition allows for the working of retarded potentials, for our intermittent and yet continuous interaction. Caveat remains for the Lagging Hypersphere (LH) filled with Antimatter and

moving less than a femtometer behind us. **LH is the proposed source of Dark Matter 'observed effects' within HU.** HU only considers unexplained Gravitational Lensing as valid evidence of Dark Matter. Spiral Galaxies rotational curve can be explained by the Gyrogravitation eq.175.

#### **2.1.5.4 VACUUM FLUCTUATIONS**

We postulate that the spatial manifold is defect-free and that **effectively** there isn't anything ahead of us. Anything with radial velocity different from  $c$  will be too far behind or too far ahead of us to interact.

What about the paradigm of vacuum (zero-point) fluctuations? HU considers that quantum systems have zero-point fluctuations. Empty space, has no boundaries and thus no stationary states. This is a useful paradigm when one considers scattering process and center of mass kinetic energy is used to defined the range of states available for products.

This view eliminates the paradox associated with ultraviolet catastrophe.

#### **2.1.5.5 ASYMPTOTIC FREEDOM**

Interaction occurs at 45 degrees through retarded potentials. This means that the Quantum Lagrangian Principle will lead to smaller and smaller accelerations as the local torsional angle approaches 45 degrees. Conversely, under extreme density (e.g. inside a Black Hole), there will be a density where the Force goes to zero again.

### **2.2 HYPERGEOMETRICAL STANDARD MODEL**

#### **2.2.1 THE FUNDAMENTAL DILATOR**

We propose that Fundamental Dilator Coherences (FDC) are the basic building block of matter. They are coherences between two metric deformation stationary states in a rotating four-dimensional double potential well. A single coherence between two 4D-space deformation states or fundamental dilator is proposed to account of all the constituents of non-exotic matter (isotopes, neutrons, electrons and protons and their antimatter counterparties) and hyper-nuclei (hyperons) on Hypergeometrical Universe Standard Model Section. This coherence is between two deformation states with 4D volumes corresponding to the electron and proton, or electron-proton coherence. Here the proton, anti-proton, electron and positron are the same particle or the fundamental dilator, just four faces of the same coin.

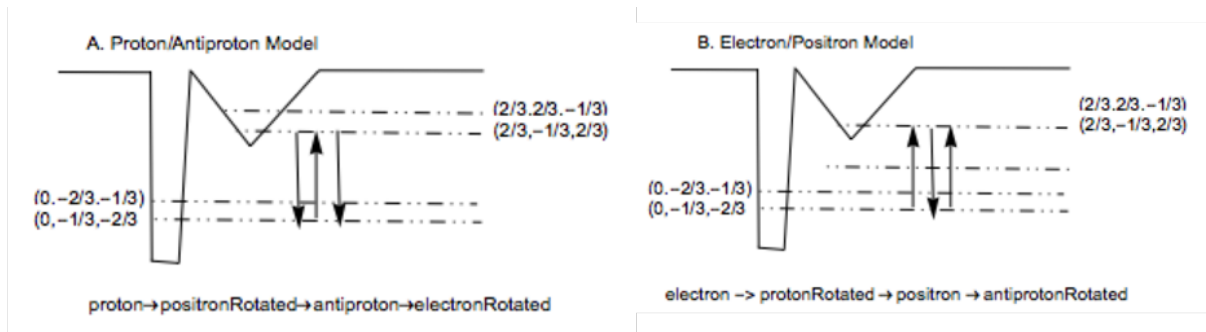

Figure 12. (a) Electron (Positron) and (b) Proton (antiproton) states. The beginning of each coherence represents the nature of the particle. Not represented in this graphic is the orientation of the state which can be in phase (flushed with the 3D Hyperspherical Universe) or off-phase (perpendicular or rotated to the 3D Universe) nor the positive or negative (stretch or compression of space) phase information.

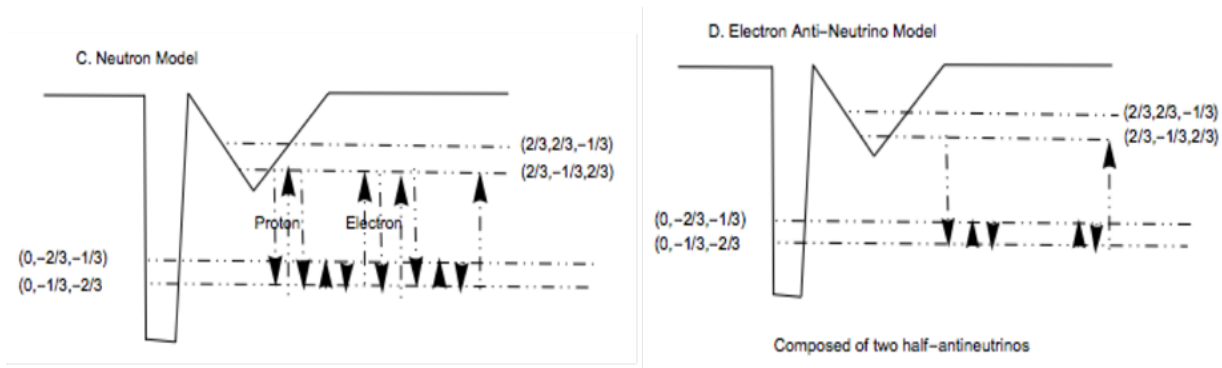

Figure 13 (c) Neutron, (d) Electron Anti-Neutrino composed of two transmutation chords (half antineutrino). **Half antineutrino transmutes an electron into a proton and vice-versa and it is named a transmutation chord. Similarly, from the assignment of pions, a half muon neutrino is a transmutation chord that converts matter to antimatter (electron into positron). By analogy, half Tau Neutrino will likely convert a proton into an antiproton.**

Fig. 14 below depicts the Balls Diagrams, representing these coherences.

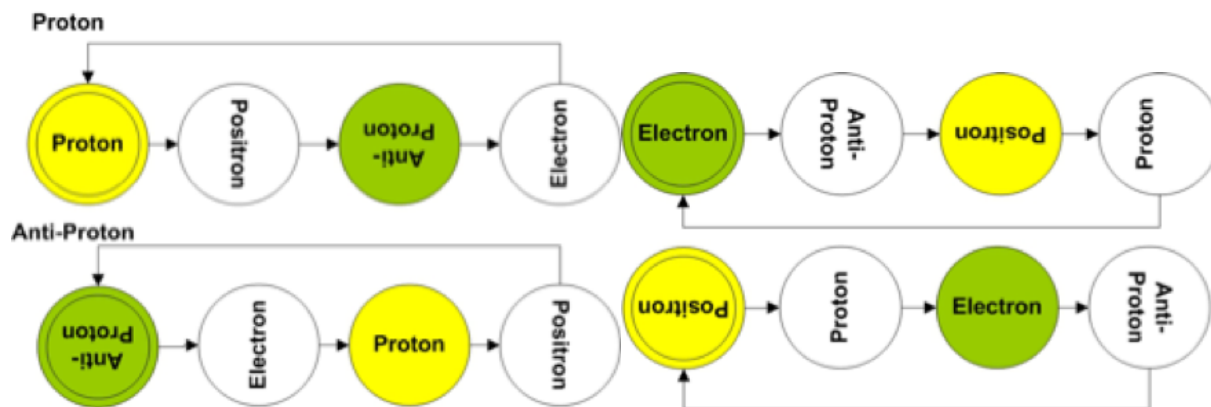

Figure 14. The 4D-mass is mapped to the 4D displacement volume of each one of those states. To understand what is a displacement volume, let's first consider a unit radius 3D sphere in a 3D spatial manifold. If space is stretched slightly along two axes and compressed along a third axis (e.g.  $2/3, 2/3, -1/3$  or the proton) by some very small arbitrary amount  $(2/3, 2/3, -1/3)*A$ , the change in volume can be approximated by the sum of those coefficients  $(2/3 + 2/3 - 1/3)*A = A$ .

Due to the inherent anisotropy of an expanding hypersphere, tangential and radial states are modeled to have approximately a unit volume while differing by an anisotropic coefficient very close to unit.

### Inertial Mass = Dilator 3D Footprint!

Since we know the masses of the 3D footprints electron and proton and since each one of these particles have positive and negative footprints, the 4D-mass of a Fundamental Dilator is considered to be the same as a Hydrogen Atom in atomic mass units to extract anisotropy.

The 3D-mass is related to inertia, while the 4D mass is related to the particle ability to create dilaton waves (dilaton field). All four states have the same ability and thus the same absolute charge.

Up to now we described charged dilators. Let's now consider a neutron and a hydrogen atom.

### 2.2.2 NEUTRON AND THE HYDROGEN ATOM

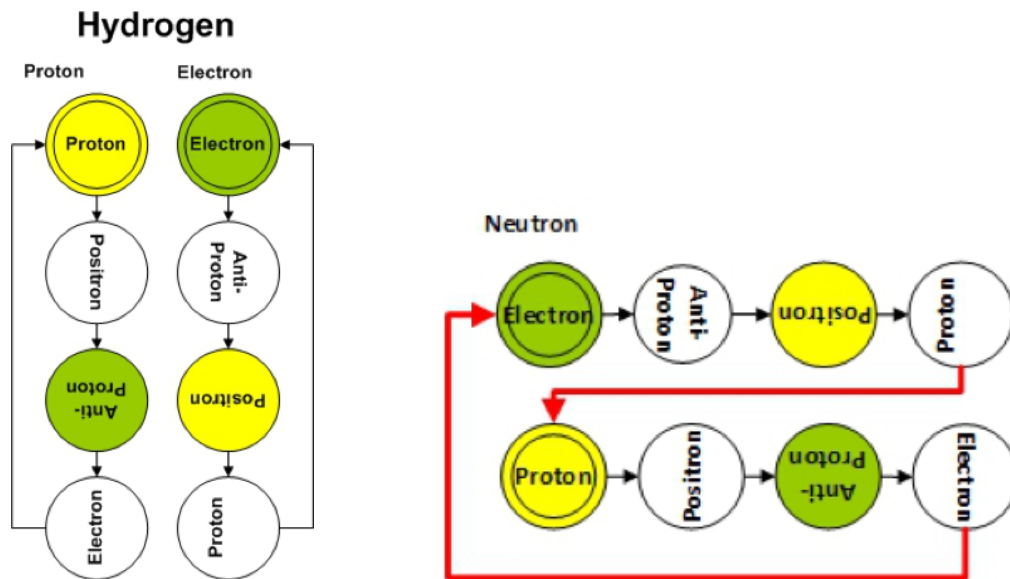

Figure 15: Hydrogen atom representing two interacting dilator coherences and neutron representing a composite coherence. The circular nature of the coherence above indicates its cyclic nature. This cycling will last the lifetime of the particle.



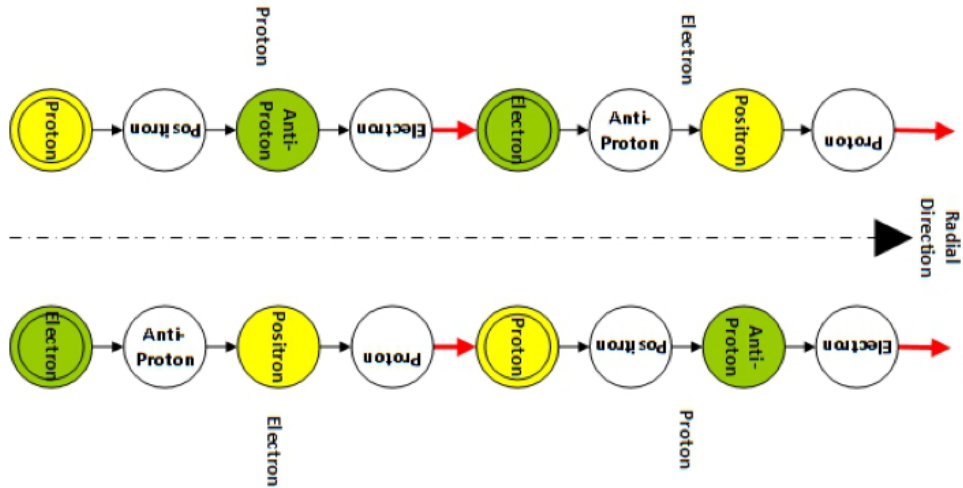

Figure 16. Neutron represented by a dimer, that is, two coherences composed each of two alternating chords, rotating  $180^0$  at each de-Broglie step of the 3D Universe expansion. The neutron dipole moment and energy stored in local metric deformation place constraints on the 3D Neutron radius or size.

Each four balls correspond to the four states of the Fundamental Dilator Coherence. The red lines are transmutation chords (half electron-antineutrino) responsible for transmuted an electron into a proton at each de-Broglie cycle. In this model, one considers that the energy associated with tunneling could be momentarily converted into a 3D rotation while spinning continues. This means that the last state (electronRotated) in the proton sequence would remain in the electron state, execute a rotation around an axis in the 3D Universe while rotating  $90^0$  perpendicular to R. This would place the next state as being electron flush with the hyperspherical surface, thus transmuted from proton into an electron within the coherence.

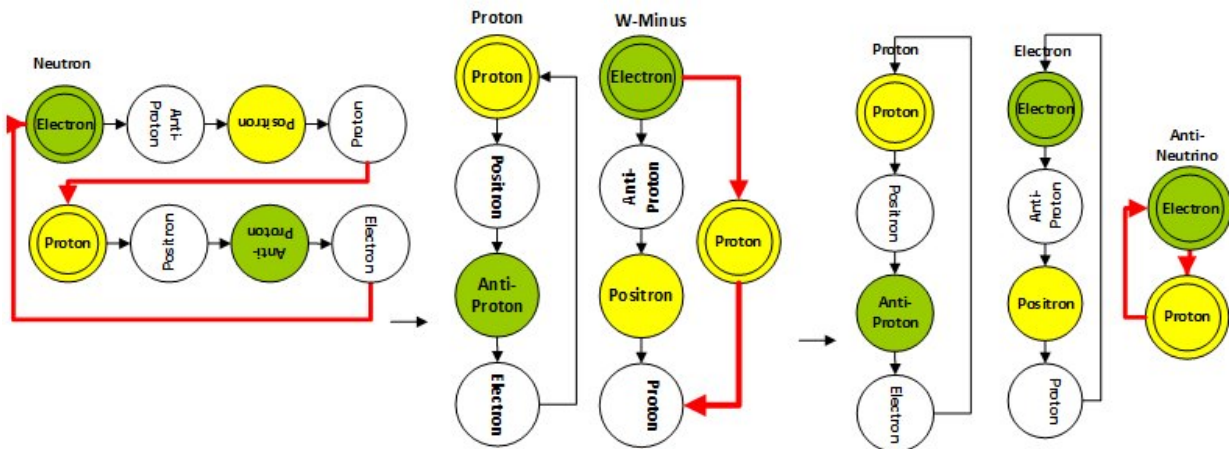

Figure 17. Neutron decays into W-Minus which subsequently decays into an electron and an electron anti-neutrino.

The neutral nature of the neutron is the result of being a rotating dimer with zero net charge.

### 2.2.3 PIONS AND ANTIMATTER

Issues related to the total spin of a coherence depend upon the sum of the individual sub-coherence spins and that includes transmutations chords (half neutrinos). Pion Decay Channels are shown in Table 2.

Table 2. Pions

Particle	Symbol	Mass	DecayReaction	Spin
PionMinus	$\pi^-$	139.57018	$e^- + n_e$	1/2
PionMinus	$\pi^-$	139.57018	$m^- - n_m$	1/2
MuonMinus	$m^-$	105.7	$e^- - n_e + n_m$	1/2

[

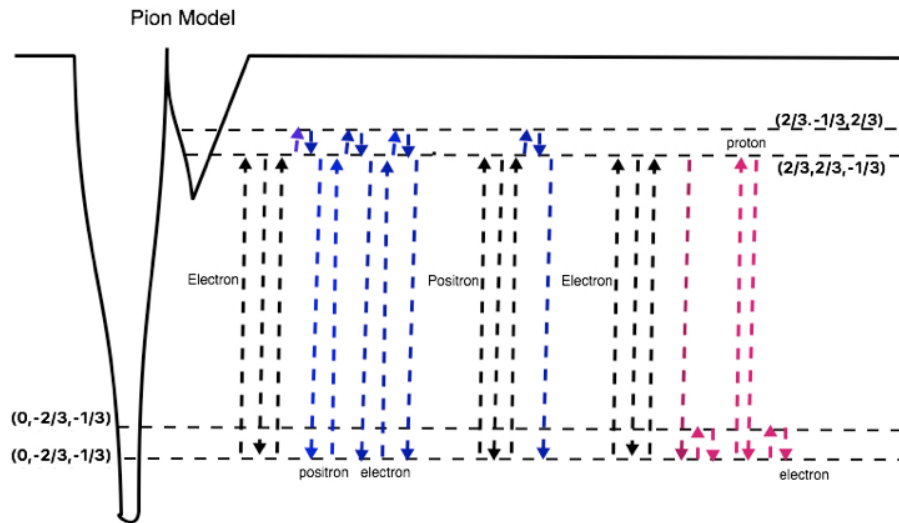

Figure 18. Pion Minus Diagram showcasing both transmutation chords. This dilator is a composite dilator with an equilateral triangle topology as seen from the radial direction (perpendicular to our 3D Universe)

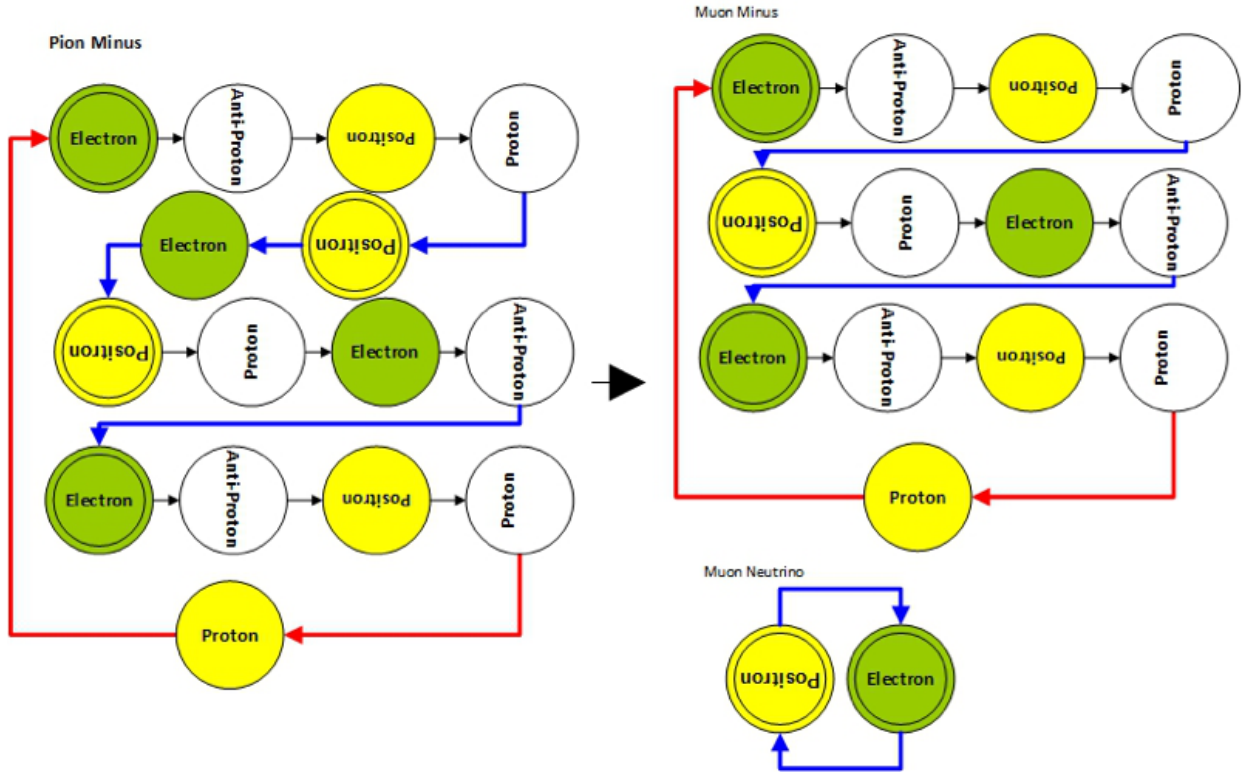

Figure 19. Pion Minus decay into Muon Minus and a Muon Neutrino.

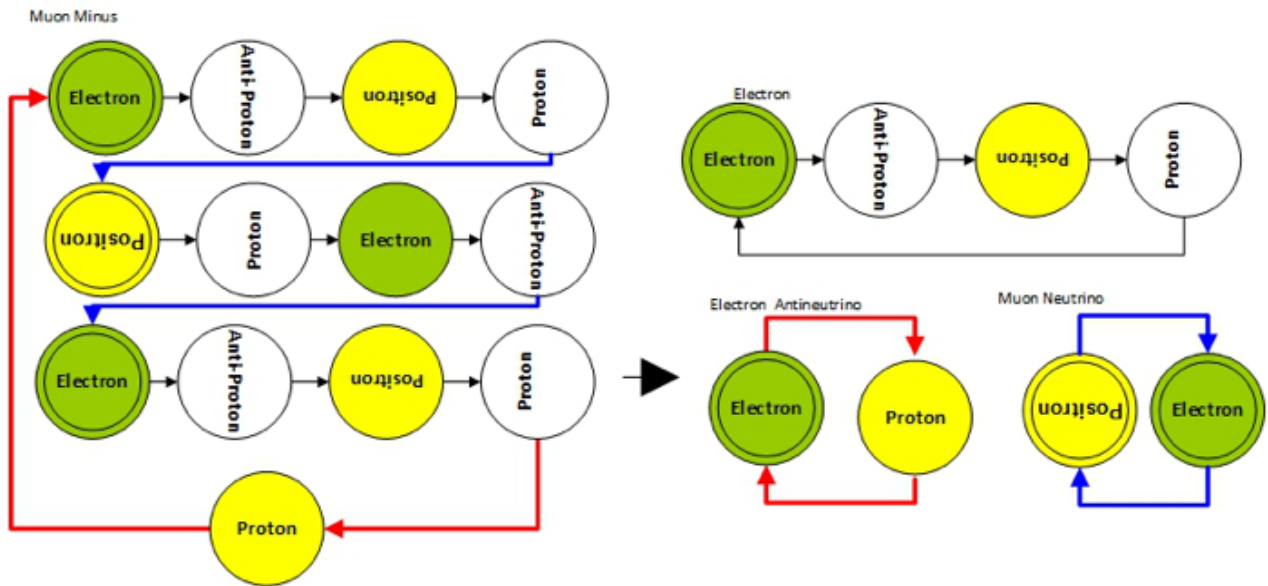

Figure 20. Muon Minus decay onto an electron and a muon neutrino. The muon neutrino can be detected at different Glutonic States where it performs one or more electron capture. The energy of the annihilation of the electron and proton is converted into kinetic energy for the decay products. Glutonic states are states that differ by the number of EFD internal coherences (e.g. Delta Plus Plus). Internal coherences are coherences not separated by a transmutation chord, thus they add no extra torsion to the composite coherence. They will be reviewed elsewhere.

The four fundamental particles (electron, proton, positron, antiproton) are modeled as different phases of the coherence between stationary deformation states of the local metric. The involved states express their nature (physical properties). Thus, at the first glance, the EFD should have a 4D-Mass identical a Hydrogen atom.

During the time taken to traverse a de-Broglie step, the dilator goes through its four phases (electron, proton, positron and antiproton) while spinning  $360^\circ$  around an axis perpendicular to the direction R (R is normal to our 3D Universe hypersurface). All times (proper time and Cosmological time  $\Phi$ ) are made dimensional by the multiplication by the speed of light c.

Pseudo-Time Quantization/de-Broglie Stepwise Expansion of the Universe are the result of the proposed model for matter based upon the Fundamental Dilator together with the proposed topology.

#### **2.2.4 NEUTRINOS GHOSTLY NATURE**

From the diagrams, the frequency of tunneling for neutrinos is different from the tunneling frequency between the Fundamental Dilator Coherence states. Since all known stable matter in the Universe is made up of composite coherences based on the Fundamental Dilator, interaction will be limited by the time integral of the interaction. Only a very close collision will be effective. Anything else will result in no interaction.

#### **2.2.5 PARTICLE TOPOLOGY**

Since the composite dilator coherences are degenerated (Fig. 19) with respect the which state is initially in phase with the Universe, a trimer would have an equilateral geometry with respect to an axis perpendicular to the 3D Universe. Below is the topology of prime composite dilator coherences (hyperon family).

- Electron/Proton/Positron/Antiproton is a point
- Neutron is a line (segment)
- Pion minus/plus is a equilateral triangle
- Delta plus/minus are pentagons
- Kaons plus/minus are heptagons
- Xis plus/minus are undecagons
- Omega plus/minus are tridecagons

More complex hyperons will be presented elsewhere.

#### **2.2.6 ELECTROMAGNETIC AND GRAVITATIONAL DILATORS**

The archetypical Electromagnetic Dilator is represented by the Proton or Electron coherences presented previously. The Gravitational Dilator is represented by a spin zero Hydrogen Atom shown in Fig. 21:

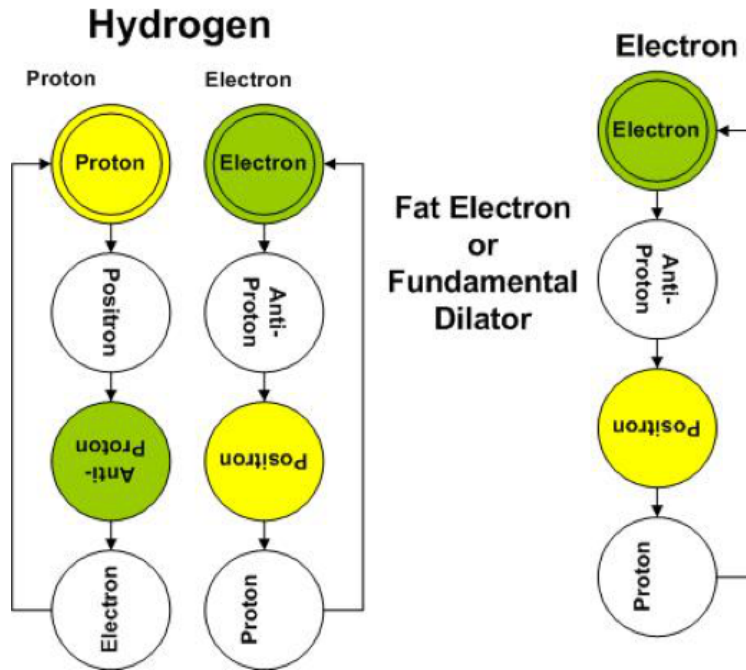

Figure.21. Archetypical Gravitational Fundamental Dilator (GFD = zero spin Hydrogen atom) and Electromagnetic Fundamental Dilator Coherence (EFD =electron).

The first thing that comes to mind is that the Gravitational Fundamental Dilator contains two Electromagnetic Fundamental Dilators. Positive and negative phases of the dilator are positioned such as to minimize dilator work, that is, the phases are positioned to be in phase with the surrounding dilaton field.

Their 3D mass or inertial mass behaves as expected. An Electrostatic Fundamental Dilator on an electron pattern has the inertial mass of an electron. A Fundamental Dilator on a proton pattern has the inertial mass of a proton.

### 2.3 D DE-BROGLIE WAVES AND THE DE-BROGLIE FORCE

What are de-Broglie waves? Are they the same as the dilaton field?

Electron 3D de-Broglie waves have a wavelength that is different from the wavelength of a Fat Electron (our proposed view of the 4D displacement volume representation). The solution to the conundrum is that the dilaton tunneling, spinning and interaction with the 3D hypershell generates a bitonal dilaton field (two frequencies):

- one (our 3D de-Broglie waves) dependent upon the dilator footprint (3D-mass) on 3D Universe.
- one dependent upon the 4D Mass.

There is the question about their amplitudes, how similar are they? Just from inspection, they seen to be equivalent to a super strong gravity since they can be expressed by a small number of

particles or even a single particle. Unlike gravity, uncorrelated particles or matter doesn't share the same wavelength as electromagnetism and gravitation. The de-Broglie dilaton field depends upon dilator footprint and velocity.

The answer to this question has implication on bunching and focusing of particles. This is extremely relevant to the pursuit of Coherent Nuclear Energy. The creation of coherent bunching of deuteron atoms for instance, followed by focusing and hadronic phase matching might be feasible.

When one focus particles, they would be subject to this bitonal dilaton field components. If the de-Broglie field is stronger than the EFD dilaton field, that might mean that homogeneous bunching with a larger number of particles, might be easier done than one with a small number of particles, clearing the path to coherent hadronics.

de-Broglie dilaton field might be bunching and debunching depending upon which phase you consider. Both phases define a trough that might neutralize enough electrostatic repulsion to allow for phase matched nuclear reactions.

First let's derive the de-Broglie law using the proposed 4D topology. Let's consider de-Broglie waves and the dilaton field for a hydrogen atom. In the case of a Hydrogen atom, the atomic mass is HydrogenMass.

Let's consider a Hydrogen atom traveling at the speed of light along the 3D Universe. The vertical line points to the Radial direction (perpendicular to the 3D Universe). The line at  $45^\circ$  corresponds to traveling at the speed of light both radially and tangentially. The oblique line indicates the projection onto the 3D Universe. Simple geometry tells you how the actual wave gets projected onto the 3D Universe

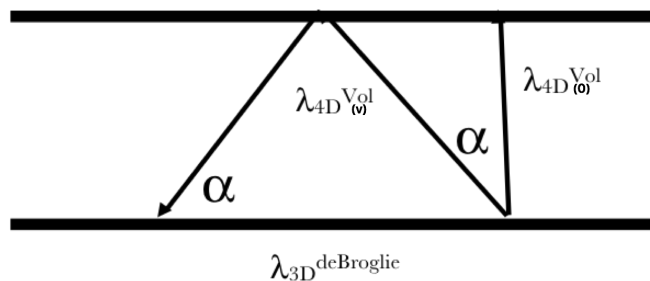

Figure 22. This diagram shows two consecutive de-Broglie steps of the 3D Universe expansion and their relation to a volumetric dilaton wave.

The  $45^\circ$  projection maps into the Compton wavelength. The horizontal lines represent steps of the 3D Universe. From the Fig. 21, it is clear that the de-Broglie wavelength in 3D is twice the one seen in 4D. This creates a coincidence between the GFD dilaton field and the de-Broglie field.

The de-Broglie equations that calculate wavelength consistent with this 4D Perspective are given by:

$$\lambda_{3D}^{deBroglie} = \frac{h}{m_{3D}v} \quad (54)$$

$$\sin(\alpha) = \frac{\lambda_{4D}^{Vol}(v)}{\lambda_{3D}^{deBroglie}} = \tan(\alpha)\cos(\alpha) = \frac{\tan(\alpha)}{\sqrt{1+\tan^2(\alpha)}} \quad (55)$$

$$\tan(\alpha) = \frac{v}{c} \quad (56)$$

$$\cos(\alpha) = \frac{\lambda_{4D}^{Vol}(0)}{\lambda_{3D}^{deBroglie}(v)} = \frac{1}{\sqrt{1+\tan^2(\alpha)}} \quad (57)$$

$$\lambda_{4D}^{deBroglie}(v) = \lambda_{4D}^{Vol}(0)\sqrt{1+\tan^2(\alpha)} \quad (58)$$

### 2.3.1 HYPERSUPERFICIAL MODE:

Calculate  $\lambda_{4D}^{Vol}$  equivalent to the  $\lambda_{3D}^{de-Broglie}$  :

$$\lambda_{4D}^{Vol}(v) = \lambda_{3D}^{deBroglie} \left[ \frac{\frac{v}{c}}{\sqrt{1+(\frac{v}{c})^2}} \right] = \frac{h}{m_{3D}v} \left[ \frac{\frac{v}{c}}{\sqrt{1+(\frac{v}{c})^2}} \right] \quad (59)$$

$$\frac{f_{4D}^{Vol}(v)}{c\sqrt{2}} = \frac{m_{3D}v}{h} \left[ \frac{\frac{v}{c}}{\sqrt{1+(\frac{v}{c})^2}} \right]^{-1} \quad (60)$$

$$f_{4D}^{Vol}(v) = \frac{m_{3D}c^2\sqrt{2}}{h} \sqrt{1+(\frac{v}{c})^2} \quad (61)$$

$$\lambda_{4D}^{Vol} \cong \frac{h}{m_{3D}c} \Big|_{v \ll c} \quad (62)$$

$$f_{4D}^{Vol}(v) = \frac{2m_{3D}c^2}{h} \Big|_{v=c} \quad (63)$$

$$\lambda_{4D}^{Vol}(v) = \frac{h}{m_{3D}v\sqrt{2}} \Big|_{v=c} \quad (64)$$

### 2.3.2 HYPERVOLUMETRIC MODE:

Hypervolumetric modes anisotropy is derived the vacuum permittivity on equations (116-122):

$$\lambda_{4D}(v) = \frac{0.29273h}{m_{4D}c} \sqrt{1 + \left(\frac{v}{c}\right)^2} \quad (65)$$

$$f_{4D}(v) = \frac{m_{4D}c^2\sqrt{2}}{0.29273h\sqrt{1 + \left(\frac{v}{c}\right)^2}} f_{4D}(c) \quad (66)$$

$$\lambda_{4D}(v) = \frac{m_{4D}c^2}{0.29273h} = \frac{m_{4D}c^2}{h^{GE}} \quad (67)$$

$$h^{GE} = 0.29273h \quad (68)$$

Equations 59-64. refers to the de-Broglie 3D waves and depends only on the 3D masses. It was made general to account for different velocities. The velocity is supposed to be invariant (low dispersion) between surface and volumetric dilatons. This is the equivalent hypervolumetric wavelength that is consistent with the observable 3D de-Broglie waves. One might conclude that the Electromagnetism and Gravitational dilaton field have 29.3% of the intensity of the de-Broglie dilaton field!

Equation 65-68 refers to the dilaton field created by all 4 phases of the dilaton coherence. One possible interpretation of the distinct nature of these dilaton modes is to map them to hypersuperficial (3D de-Broglie waves) and hypervolumetric (dilaton field responsible for volumetric forces – electromagnetism and gyro-gravitation). There is an inherent uncertainty between superficial and volumetric waves in the context of waves on a surface attached to the moving frame of reference. The distinction should be made with respect to k-vectors. A superficial wave has a k-vector on the surface, while a volumetric wave has a k-vector perpendicularly to the surface that is free to move as the surface is tilted by interaction. Due to moving reference framework it is possible to map a superficial mode to a volumetric mode.



Again, the k-vector for these dilaton waves are perpendicular to the local FS. This is necessary for creating a simple picture of the 3D de-Broglie waves. The dilaton field propagating radially outwards corresponds to a dilator with zero velocity. Since the dilator k-vector is perpendicular to the 3D hypershell, the projection wavelength is infinite. As the dilator changes velocity, the reentering dilaton field projects the original wavelength into our known matter waves.

The Hypergeometrical Universe theory recognizes this as a yet unknown Force, not unlike Gravitation or Electromagnetism. The mathematical formulation for force calculation is identical to other forces and presented in the next section. Specifics of this force as well on how to physically mold spacetime will be covered in detail elsewhere.

## 2.4 HYPERGEOMETRICAL UNIVERSE PHYSICS

From Fig. 1, the rate of torsion of the local FS is proportional to the force (Hypergeometrical Universe interpretation of **Newton's Second Law** is giving by:

$$F = m_{03D} c^2 \frac{dtanh(\alpha_\tau)}{d\tau} \quad (69)$$

Adding the extra spatial dimension implies that:

$$F = m_{03D} c^2 \frac{dtanh(\alpha_\tau)}{d\tau} = m_{04D} c^2 \frac{dtan(\alpha_r)}{dr} \quad (70)$$

### 2.4.1 SPACE STRESS-STRAIN PARADIGM

In a geometrical theory, the only relevant constructs are space, time, dilators, dilaton fields (dependent upon dilators position, velocity and space properties). A theory about the Universe based on those constructs would recast equation (69) as:

$$Stress = Area4D \ Strain4D = Area3D \ Strain3D \quad (71)$$

$$Area4D = m_{04D} c^2 \quad (72)$$

$$Area3D = m_{03D} c^2 \quad (73)$$

$$Strain4D = \frac{dtan(\alpha_r)}{dr} \quad (74)$$

$$Strain3D = \frac{dtanh(\alpha_\tau)}{d\tau} \quad (75)$$

The force between dilators can be calculated on the RXYZ frame.

From Fig. 21, it becomes evident the reason why the 4D Mass of the Fundamental Dilator is initially mapped to the mass of a hydrogen atom in atomic units.

Transmutations chords redirect energy from tunneling into rotating in the 3D Universe, thus changing which phase is flush with the 3D Universe at the subsequent state. These chords (half-neutrinos) carry angular momentum since they correspond to rotations. They also carry linear momentum since they have a footprint on the Universe and are accelerated during the dissociation process. Since they have a different frequency, they will not produce anything that might be construed as a Gravitational nor Electromagnetic field. This would mean that it is meaningless the search for the neutrino mass as a potential indicator of the matter-induced spacetime curvature.

The EFD is a charged dilator and will be used as a probe for electromagnetism. For gravitation, the Fundamental Gravitation Dilator (GFD) archetype used will be a Hydrogen atom.

The introduction of a Fundamental Dilator and the concept of 4D Masses eliminates the asymmetry between electrons and protons and allow for the derivation of Natural Laws from first principles on a 5D Spacetime.

In this theory, a force capable of moving a body corresponds to a stress capable of deforming the Fabric of Space where that body is located. Notice that the body only has footprints on the FS where the dilators are. The strains are given by:

$$\frac{d \tan(\alpha_r)}{dr} \tag{76}$$

and

$$\frac{d \tanh(\alpha_t)}{d\tau} \tag{77}$$

where the angles are shown on the two cross-sections on Fig. 1. The “areas” where the strain takes place are given by  $m_{4D}^0 c^2$  and  $m_{3D}^0 c^2$ , respectively. They provide the extensive nature associated with mass in our current view.

Deformation of the Fabric of Space can be understood as acceleration from equation(69).

**Newton’s Third Law** also has a representation within this theory. The stress on interacting dilators (bodies) is also the same with opposing signs; this is equivalent to say that the force felt on each other is equal with opposite signs. This law is valid both on the RXYZ and in the  $\Phi XYZ$ . In addition, one can equate

$$Area_{3D}(1) Strain_{3D}(1) = Area_{3D}(2) Strain_{3D}(2) \tag{78}$$

where the indices refer to the particles. This applies to each de-Broglie step. This recast Newton’s Third Law also as Archimedes Law of Lever if one focus on a single de-Broglie step.

**Newton’s fourth law** is the Natural Law of Gravitation which will be derived later from first principles. The above equations are the basis for the more fundamental theoretical development in this theory. In first analysis, it is just an extrapolation of Newton’s Law, which only covers the 3D space and introduces an unknown quantity F (Force). The introduction of a fourth spatial

dimension allows for the creation of a purely geometric tautology relating Stresses on the two cross-sections shown on Fig. 1.

**The stress associated with interaction is then same on both cross-sections.**

The strain is expressed differently in each cross-section and that permits the derivation of our fundamental laws of physics (Newton's, Gauss's, Biot-Savart's) from first principles.

**Notice that the dilators will surf the XYZ on the XYZR cross-section. Our interpretation of events (dynamics) will be defined by the evolution of the dilator on  $xyzT$  manifold.**

#### 2.4.2 PSEUDO TIME-QUANTIZATION AND THE STROBOSCOPIC UNIVERSE

Pseudo Time-Quantization arises when one considers Newton's Law, where mass attracts mass at the direct products of their values. On the intermediate phases, the 3D overlap of the fundamental dilator with the FS goes to zero and so goes its perceived 3D mass, resulting in an intermittent interacting Universe (Stroboscopic Universe).

This pseudo-time quantization and the introduction of a fourth-spatial dimension creates inherent uncertainties in the dynamics of dilator which together with the Quantum Lagrangian Principle would result in the basis for Quantum Mechanics. At each de-Broglie step, the next position where two interacting dilators (e.g. Hydrogen atom) would be depends upon their overlapping dilaton field at specific radial positions. The wavelengths and k-vectors on  $XYZT$  depends upon velocity.

At any given step, the electron dilator should be in any one point on a circle drawn in the 3D space. That is the basis for the deterministic and yet uncertain motion in quantum mechanics. The loci of those steps should map to the probability density function. Since this theory is providing guidance for the underlying dynamics, it should be feasible to derive Schrödinger's equation from first principles.

In the past, I considered that the eigenstates would be stable in the sense of a Poincare' map, that is, one would start calculating trajectories:

1. start the trajectories from an initial position from the other particle (e.g. electron at position  $x$  from proton in a Hydrogen atom).
2. by using 3D interferograms (to calculate the forces actuating on the dilator at any given time).
3. use those forces to calculate motion on  $XYZT$ . Cycle back to item 2.

I expected that by starting the trajectories at different distances (different potential energies), stable Poincare' maps would naturally arise corresponding to the eigenstates. I considered that the de-Broglie field was present as an initial condition at each de-Broglie step of the Universe expansion.

After discovering the de-Broglie field (realizing that it was a real dilaton field mapped to a hypersuperficial dilaton mode), I realized that the de-Broglie field should be part of the protocol above to recover Quantum Mechanics. The reason being is the self-interaction with the de-Broglie field during the double slit experiment. If the field is there when there isn't any other potential, it should also be there when there is a potential.

This conclusion doesn't affect the derivation of Gauss, Newton and Biot-Savart Laws since they are large-body equations (non-Quantum Mechanical) that used the large N approximation in the derivation. Derivation of the Schrödinger equation or the Bohm equation is not in the scope of this work.

### **2.4.3 QUANTUM LAGRANGIAN PRINCIPLE**

The Quantum Lagrangian Principle is nothing more than a direct result of the quantization of space deformation or metric deformation. It states that:

#### **DILATORS ALWAYS DILATE LOCALLY IN PHASE WITH THE SURROUNDING DILATON FIELD**

Since Gravitation and everything else is described in terms of metric deformations, all fields are quantized in a sense but not in another. Gravitational/Electromagnetism fields are dependent upon dilaton fields from dilators which provide quantized dilations amplitudes and have to be at any given time on a well-defined spatial interference patterned grid, although not at quantized distances. This means that the generation of the field is quantized but the actual dilaton field is not.

This means that interacting dilators (e.g. Hydrogen atom composed of electron and proton), will always be at the nearest maximum dilation (contraction) for proton (electron) at each de-Broglie step of the Universe expansion. The phase choice is arbitrary. This means that the electron (the most mobile) will have an uncertain trajectory due to the azimuthally nature of the interferometric dilaton pattern resulting from proton-electron interaction.

The motion of a dilator can be thought in the RXYZ cross-section as being the interference between a self-wave which wavelength depends upon the torsional angle of the local metric. For relaxed space (angle=zero), the wavelength of a GFD is  $\lambda_1$ . If this dilator were accelerated to the speed of light tangentially (within the 3D), the wavelength would stretch to  $\sqrt{2}\lambda_1$ . This condition is required to keep in phase with the 3D Universe.

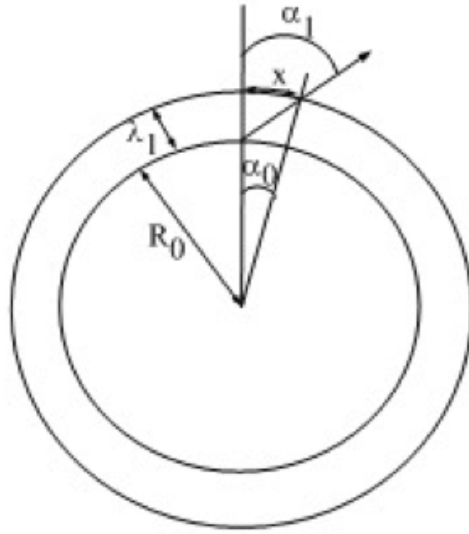

Figure 23. This shows a de-Broglie step  $\lambda_1$  (Compton wavelength of a Hydrogen atom for GFD).  $R_0$  is the age of the Universe times the speed of light.  $\alpha_1$  ( $\alpha_0$ ) corresponds to the FS normal direction for Electrostatic (Gravitational) interaction.

Due to the Quantum Lagrangian Principle, position  $x$  show in Fig. 23 is calculated from the interference pattern between the dilator self-generated field and the Cosmological Field reaching that region of the 4D spatial manifold. The math is quite simple, just add the two waves and calculate the maximum or minimum. That will be the position of the dilator in the next de-Broglie step.

QLP applied to EFD allows the local metric deformation angle to be exactly the one calculated from  $x$  and  $\lambda_1$ .

QLP applied to GFD would have the same  $x$  motion but the FS deformation would be  $\alpha_0$ . Calculations indicate the existence of an adiabatic effect, thus yielding a larger deformation than expected.

Using the known Gravitational constant at  $R_0$ , a simple elasticity parameter is calculated. This allows for the calculation of the natural frequency of gravitational waves.

#### 2.4.4 MECHANISM OF ATTRACTION AND REPULSION

To derive the laws of Nature, we first need a picture of what is happening during attraction or repulsion. We first write the deformational waveform for the dilaton field. This formula is valid for both electrostatic and gravitational interaction since the amplitude of each dilaton field is equal to the amplitude of the dilator at specific times of the expansion and they can be normalized to unit.

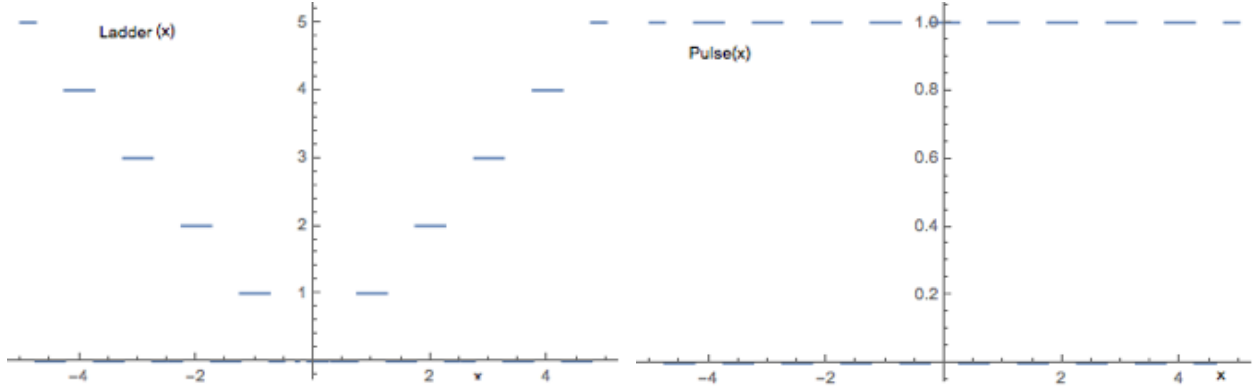

Figure 24: Ladder and pulse functions used to show how the dilator amplitude decays as a function of de-Broglie steps and cycles of the dilaton field.

Mathematica Functions:

$$\begin{aligned} ladder[x] &= HeavisideTheta[SawtoothWave[x - 0.25] - 0.5] * Round[Abs[x]] pulses[x] = \\ &= HeavisideTheta[SawtoothWave[x - 0.25] - 0.5] \end{aligned}$$

The full dilaton field is given by

$$\Psi_1(x, x_0) = \frac{\cos(k_1 \cdot (x - x_0))}{(1 + f(k_1 \cdot (x - x_0)))} \quad (79)$$

$$\Psi_2(x, x_0) = \frac{N \cos(k_2 \cdot x)}{(1 + f(k_2 \cdot (R - x)))} \quad (80)$$

$$\Psi_{Total}(x, x_0) = \Psi_1(x, x_0) + \Psi_2(x, x_0) \quad (81)$$

$$f(k \cdot x) = ladder[x] \quad (82)$$

The function ladder is used to implement the dilution of the initial dilaton amplitude (unit) into the number of cycles. So the first cycle the intensity is 1, at the second it is 1/2, at the third it is 1/3, etc. The only relevant part of the dilaton field for force derivation are the peaks because dilators land there at each step of the 3D Universe expansion. The derivative of the ladder function is zero for  $x=0$ .

$$\left. \frac{df(x)}{dx} \right|_{x=0} = 0 \quad (83)$$

The pulse function was used to show only that region and not the negative part of each cycle. Plots were generated with the function below:

$$\Psi_2(x, x_0) = \frac{N \cdot \cos[k \cdot (R - x)] * pulse[x]}{(1 + ladder(N \cdot (R - x)))} \approx \frac{N}{(1 + f(k_2 \cdot (R - x)))} \quad (84)$$

if N (number of dilators) is very large, the oscillations are extremely close to each other and the approximate version of the equation (80) is used. Notice that when  $x-x_0=R$  is a macroscopic distance:

$$\frac{d\Psi_2(x, x_0)}{dx} = \frac{N * N * k}{(N * k * (R - x))^2} = \frac{1}{kN^2(R - x)^2} = \frac{N\lambda_2}{2\pi R^2} \quad (85)$$

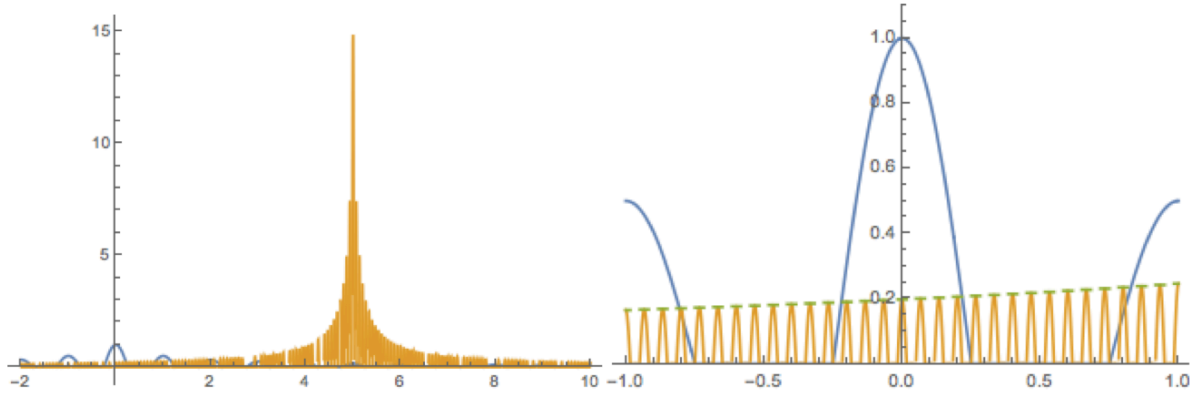

Figure 25. (a) shows a probe dilator (at origin) interacting with a 4D-Mass of 15 dilators. (b) shows where the dilator would land (slightly right from zero if this is an attractive interaction or to the left if not).

Attractive or repulsive interaction are defined by the gradient of the peaks, which depends if the initial oscillation was positive or negative. In the case of Gravitation, the picture remains the same, but the amplitudes are much smaller due to countervailing actions of positive and negative dilators. The increased amplitude of the dilaton field with increasing number of dilator is the result of the Quantum Lagrangian Principle.

Dilators' amplitudes add together as opposed to averaging to zero in an ensemble. The increase in frequency is due to the physical volume from which the dilaton field emanates, thus arriving at different phases at any given point of space but adding together back properly at the right positions.

**Attraction happens when interaction reduces local metric deformation. Repulsion happens otherwise.**

For gravitation the picture is similar. The question is how the gradient is different for matter and antimatter? **Van der Walls forces are always attractive and that might be the case for Gravity since they originate from a similar process.**

This theory provides a path for matter-antimatter conversion, thus opens the door for antimatter propulsion and gravity suspension. Other paths to gravity shielding will be discussed elsewhere.

### **2.4.5 WHAT IS THE EFFECT OF AN EXTRA DIMENSION ON NATURAL LAWS (GRAVITATION, LIGHT PROPAGATION, ELECTROMAGNETISM)?**

Current scientific view is that a field carrying a force, spreads out onto an “area” to dilute the Force. Changing dimensionality of space, changes the “area’s” dimensionality. This straightforward geometric restriction exists because of the observational dependence of forces with inverse distance squared. Without knowing how to derive Natural Laws, scientists unduly extrapolated this argument to restrict any non-compact higher dimensional theory. HU has an extra non-compact dimension (the Radial dimension).

Notice that this restriction/argument is model dependent, despite of the fact that up-to-now there was no model which could replicate reality in a higher dimensionality Universe. HU does exactly that.

HU proves that this restriction is not warranted and that the inverse distance squared dependence is recovered even when the extra radial dimension is added, if we have the dynamic framework of the observed Universe being in a light speed expanding hypersphere.

The clue to how this is accomplished it is the same as the one to photon confinement. The short answer is that HU considers Gravitation and Electromagnetism and photons are carried by metric waves (dilaton field). This dilaton field knows about the extra spatial dimension. It just doesn’t care, in the sense that its work (dephasing) will only be felt by matter (dilators) contained within our hypersphere. This means that despite of the dilaton field traveling within the 4D spatial manifold, our observation of it only happens through retarded potentials leaving at 45 degrees the hypersphere and traveling through a line-of-sight path.

This means that interaction is always UNIDIMENSIONAL. The loci of Supernova explosions are the curved line shown in Fig. 6.

Any other path wouldn’t ever meet a dephasing event and would arrive too early or too late for us to detect it, not satisfying the Time-Of-Arrival constraint.

The Time-of-Arrival constraint, reduces interaction dimensionality (to 1D)! Of course, the force intensity has a one-dimensional dependence. The force direction requires the full 4D spatial manifold to be characterized.

### **2.4.6 THE MEANING OF SPIN**

The Fig.26 shows the formation of ortho- and para- Hydrogen atoms.



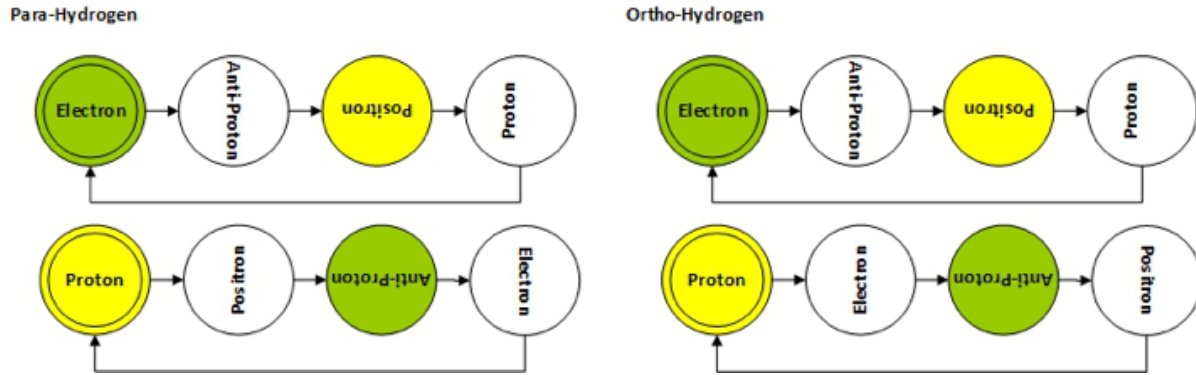

Figure 26. This shows that a negative spin means time reversing the cycle of the Fundamental Dilator Coherence. Para-Hydrogen has lower energy due to the attractive interaction during the perpendicular phases. Similar considerations are applicable to Cooper Pairs in Superconductivity. In fact, in Cooper pairs, the intermediate matching is perfect. This understanding of spin will allow for the exploration of hidden Universe that is here when we momentarily don't exist (in the sense, "I interact, therefore, I exist").

#### 2.4.7 THE MEANING OF INERTIA

Inertia maps to the overlap of the dilator with FS at specific phases when the Universe interacts. At those phases, the larger the overlap, the larger the inertia will be. The reason lies on the Stress-Strain view of interaction. Interacting dilators create dilaton fields which affect the position of other dilators at subsequent de-Broglie steps. This is equivalent to changing the propagation direction within the 4D spatial manifold and thus locally deform the FS. The larger the area that should be deformed the larger the required stress (Force), thus the larger the inertia.

The intersection of this 4D dilator displacement volume with the very thin 4D Universe (Fabric of Space) multiplied by a 4D mass density corresponds to the perceived 3D mass, a familiar concept. Since both the dilator and the Fabric of Space are very thin, the intersection decreases extremely rapidly with spinning angle/phase tunneling. The interaction between dilators and dilaton fields (generated by other dilators) is directly dependent upon that footprint.

Since the footprint is non-null only at specific spinning angles, interaction is quantized and "existence" is quantized. Where existence was construed according to the following paradigm: "I interact, therefore I exist". Neutrinos have been called "Ghostly Particles" due to their very small interaction with the rest of the Universe (dilators) and different de-Broglie wavelength. Fig.13 and Fig.14 shows that neutrinos correspond to coherences with different wavelength or frequency than the Fundamental Dilator, thus resulting in alternating interactions that are only effective at very short range, thus making neutrino matter interaction cross-section very small.

#### 2.4.8 NEWTON'S FIRST LAW - WHY DO THINGS KEEP MOVING?

HU equates motion to the surfing of a lightspeed expanding hyperspherical shockwave

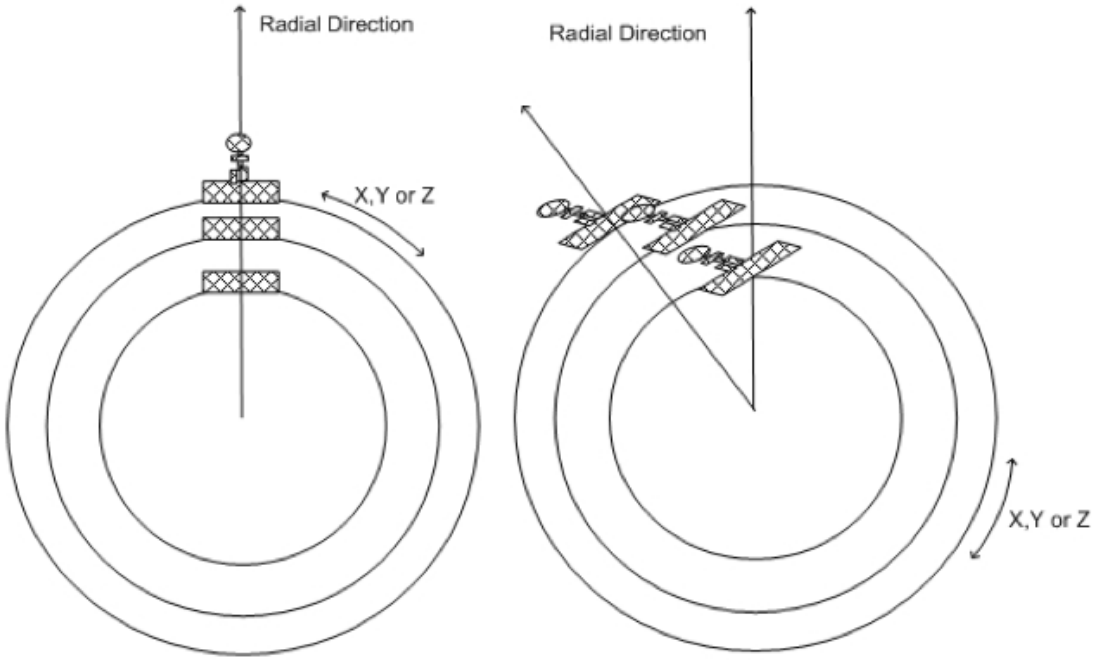

Figure 27. This showcase HU paradigm of motion as surfing the Lightspeed Expanding Hyperspherical Shockwave Universe. If the Fabric of Space (FS) is relaxes, only radial motion will occur. If interaction twists FS to the left, motion will take place towards the left (normal to the local FS).

EPPUR SI MUOVE

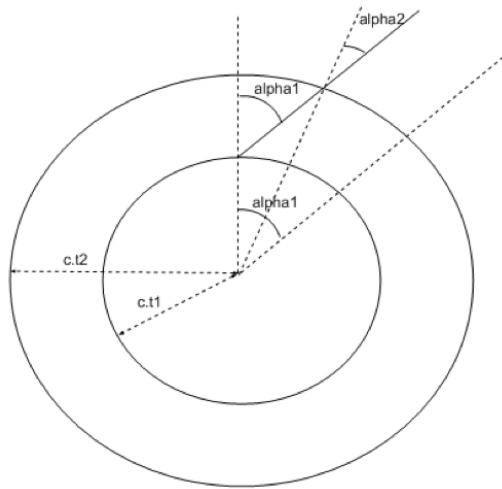

Figure 28. Here we present a dilator in motion and its position on two de-Broglie steps. The local metric is perpendicular to the direction of propagation. It shows that the angle with respect to the radial line becomes smaller (more relaxed FS) as motion takes place and asymptotically the Cosmological angle tries to reach  $\alpha_1$  or the initial local metric twist angle.

As time goes by, the local metric deformation described by the angle  $\alpha_1$  becomes the smaller  $\alpha_2$ , thus motion results in a more relaxed local metric. Conversely, one could say that that is the

reason for inertial motion, thus providing a reason for Newton's First Law. Alpha equal zero means that the dilator would propagate along the radial direction and that the local metric would be totally relaxed. This also means that current Universe should be mostly relaxed.

Notice that the apparent motion will still exist since the fabric of space is expanding and any place in the 3D universe has a Hubble expansion velocity. Although moving relatively to its original position, the body remains static with respect to the fabric of space (alpha parallel to R). At that point, the local deformation ceases to exist and the body drifts with the expansion at the Hubble velocity. In other words, motion is a way for 4D space to relax; in the same way, a tsunami is the means for the sea to regain a common level.

## 2.4.9 COSMOLOGICAL COHERENCE

Given that dilators obey the Quantum Lagrangian Principle, thus are never dephased by interactions, then it becomes clear that all dilators are in-phase throughout the Universe, creating a Cosmological Coherence.

The existence of macroscopic coherence is the underlying reason why the concept of field can work. If one considers a field to be a property of space, then the coherent addition of dilaton fields is a requirement for the fields to be an extensive property of the number of dilators

## 2.4.10 DILATOR ARCHETYPES

Before the derivation of Gauss Electrostatics and Newton's Gravitation Laws, lets discuss the meaning of a dilaton field for a Gravitational Fundamental Dilator (GFD) and for an Electromagnetic Fundamental Dilator. The electrostatic dilaton field is easy to understand

1. (EFD). Fig. 21 shows the Electrostatic Fundamental Dilator going through the spinning and space deformational changes. Deforming space should create propagating deformation waves on the Fabric of Space. There is a subtle and very important difference between dilators and dilaton fields. Dilaton Fields propagate at the actual speed of light,  $\sqrt{2}c$ . The 3D Universe propagates at  $c$  along the radial direction. The dilator is part of the 3D Universe and thus travels at that speed. Hence, a dilator is a dilaton wave generator that travels at lower speed than the waves it creates. At each de-Broglie step the local metric displacement volume is unit. In this theory, a unit amplitude of deformation is associated with the location where the dilator lands. This is the same for both electron state and proton state because they both have the same absolute value of coherently added 4D displacement volumes.
2. (GFD) For the Gravitational Fundamental Dilator shown in Fig. 21, the analysis is similar. Since GFD is a Hydrogen atom, any EFD (half of a GFD) will be both attracted and repelled. This process has similarity to Van der Waals forces. The difference is that the fluctuations are not related to charge position fluctuation but to charge transmutation at each half de-Broglie step, which happens in yoctoseconds.

Since the effect of these fluctuations on EFD comprising GFDs should be null, one would expect no effect force nor deformation of the local metric. If one starts with a relaxed local metric, the

GFD should land on a place where the Fabric of Space is also relaxed. That is the support for the caption in Fig. 23. Like in the Van der Walls forces, there will be a residual effect (Gravitation), that is, there will be an effective dilaton field generated and the corresponding GFD will follow the Quantum Lagrangian Principle and move to position x on Fig. 23, independently of them being GFD or EFD. The difference will be what happens in subsequent steps. In the case of an Electrostatic Fundamental Dilator, the local metric will be twisted and the k-vector (direction where the EFD is traveling) will be changed by  $\alpha_1$ . In the case of a Gravitational Fundamental Dilator the change in k-vector is just  $\alpha_0$ .

To calculate the position x and thus the value of the Force, one needs to map charges and 3D masses to number of dilators. One Kg4D of Hydrogen contains the same number of GFD dilators as one Kg4D of electrons (or protons) EFD.

#### 2.4.11 RELATING CHARGES AND 4D MASSES

First let's express Gauss law in terms of two interacting bodies of  $N = (1000 \text{ Avogadro})/\chi$  of dilators separated by one-meter distance. The reason for expressing Gauss Law in term of N is to have a term of comparison with Newton's Law, that is, both Gravitational and Electrostatic laws should be measuring the effect of the same number of dilators (N electrons or N Hydrogen Atoms).

For the Electrostatic Force between two one N- EFD dilator masses:

The standard MKS equation for electrostatic force between two one Kg4D bodies of  $N = 1000 \cdot \text{Avogadro}$  electrons ( $\chi$  a.m.u. "electrons" or "protons") is giving by:

$$F = \frac{1}{4 \pi \epsilon_0} \left( \frac{\text{Coulombs}}{\text{meter}} \right)^2 \left( \frac{\text{EFD}}{\text{Coulombs}} \right)^2 \left( \frac{N \text{ EFD}}{\chi \text{ Kg4D}} \right)^2 \left( \frac{\text{Kg4D}}{\text{Kg3D}} \right)^2 (\text{Kg3D})^2 \quad (86)$$

$$F = G_{\text{Electrostatic}}^{4D} \left( \frac{\text{Kg3D}}{\text{meter}} \right)^2 \quad (87)$$

We make  $((\text{Kg4D})/(\text{Kg3D})) = 1$  that is, we impose a one-to-one mapping between a 3D volume (footprint of dilators in the 3D Hypersphere and the actual effective 4D volume). This is possible since we are using an effective 4D-Mass  $\chi$  a.m.u. per dilator. This factor  $\chi$  is justified in terms of anisotropy in and perpendicular to the FS.

$G = \text{gravitational constant} = 6.6740810^{-11} m^3 kg^{-1} s^{-2}$

$\chi$  is the EFD effective 4D-Mass in a.m.u.

$$G_{\text{Electrostatic}}^{4D} = \frac{1}{4 \pi \epsilon_0 (\text{Kg3D})^2} e^2 \left( \frac{N}{\chi} \right)^2 \quad (88)$$

For the Gravitational Force between two one Kg4D dilator masses:

$$F = G \left( \frac{1}{\text{meter}} \right)^2 \left( \frac{\left( \frac{N}{2\chi} \right) \text{GFD}}{\text{Kg4D}} \right)^2 \left( \frac{\text{Kg4D}}{\text{Kg3D}} \right)^2 (\text{Kg3D})^2 = G_{\text{Gravitational}}^{4D} \left( \frac{\text{Kg3D}}{\text{meter}} \right)^2 \quad (89)$$

$$G_{\text{Gravitational}}^{4D} = G \left( \frac{1}{2\chi} \right)^2 \quad (90)$$

So the ratio between the forces between two N-EFD (EGD) separated by 1 meter is given by:

$$\frac{G_{\text{Electrostatic}}^{4D}}{G_{\text{Gravitational}}^{4D}} = \frac{1}{4 \pi \epsilon_0 G} (2Ne)^2 = 5.E + 30 \quad (91)$$

One Kg4D of GFD contains half the number of EFD in the same displacement volume.

## 2.5 FORCE UNIFICATION

### 2.5.1 QUANTUM GRAVITY AND ELECTROSTATIC INTERACTION

Let's consider:

$$\vec{r}_0 = \begin{pmatrix} 0 \\ 0 \\ 0 \\ 0 \end{pmatrix} \text{ and } \vec{R}_0 = \begin{pmatrix} R \\ 0 \\ 0 \\ 0 \end{pmatrix} \quad (92)$$

Vector expressed in terms of xyzR coordinates

After a de-Broglie cycle ( $\lambda_1$ ):

$$\vec{r} = \begin{pmatrix} r\alpha \\ r\beta \\ r\gamma \\ \lambda_1 \end{pmatrix} \text{ and } \vec{R}_0 = \begin{pmatrix} R \\ 0 \\ 0 \\ \lambda_1 \end{pmatrix} \text{ and } \vec{r}_0(\lambda_1) = \begin{pmatrix} 0 \\ 0 \\ 0 \\ \lambda_1 \end{pmatrix} \quad (93)$$

using director cosines  $\alpha, \beta, \gamma$ .

$\vec{r}_0(\lambda_1)$  is the unperturbed crest of our four-dimensional dilator 1 after a de-Broglie cycle.

$\vec{r}$  is the position of that same probe dilator under the influence of dilator 2.

To analyze the interaction between a probe dilator and a 1 Kg4D body (N= 1000\*Avogadro and 1Kg4D contains  $N/\chi$  EFD or GFD), let's express the dilaton field for a single particle as:

$$\Psi_1(x, x_0) = \frac{\cos(k_1 \cdot x)}{(1 + f(k_1 \cdot (x - x_0)))} \quad (94)$$

Where

$$f(\vec{k} \cdot \vec{r}) = |\vec{k} \cdot \vec{r}| \quad (95)$$

There is a constraint on f(x), which is that  $\frac{df}{dx} = 0$  for x=0. For any other position,  $\frac{df}{dx} = \vec{k} \cdot \hat{r} = k_x$ .

For sake of plotting, we use a stepwise constant function, implemented by the function ladder[x].

Similarly, for a N-dilator body located at position  $\vec{R}$ :

$$\Psi_2(x, x_0) = \frac{N \cos(k_2 \cdot x)}{(1 + f(k_2 \cdot (x - R)))} \quad (96)$$

where the effect of the 1 N-dilator mass is implicit in the k2-vector and expressed by the factor N. Later, when representing 1 Kg4D mass, we will replace N by N/χ. The wave intensity scales up with the number of particles N.

$$\|k_2\| = N \|k_1\| \quad (97)$$

To calculate the effect of gravitational/electrostatic attraction, one needs to calculate the displacement on the dilaton field maximum around each particle or body due to interaction with the dilatons generated by the other body.

This is done for the lighter particle, by calculating the derivative of the waveform and considering the extremely fast varying gravitational wave from the macroscopic body always equal to one, since the maxima of these oscillations are too close to each other and can be considered a continuum.

The total waveform is given by:

$$\Psi_{Total}(x, x_0) = \Psi_1(x, x_0) + \Psi_2(x, x_0) = \frac{\cos(k_1 \cdot x)}{(1 + f(k_1 \cdot (x - x_0)))} + \frac{N \cos(k_2 \cdot x)}{(1 + f(k_2 \cdot (x - R)))} \quad (98)$$

$x_0$  is the position in the prior de-Broglie step of the Universe expansion.

## 2.5.2 WHY IS THE LIGHTSPEED C THE LIMITING SPEED IN THIS UNIVERSE?

The reason can be seen by taking of the derivative equation (98) with respect to x and equating it to zero. Normally we consider that  $x_0=0$  as we are considering just the first step. Here we kept  $x_0$  to determine asymptotic behavior of dilators under extreme fields.

Under extreme fields, let's consider that  $\Phi_2$  is saturated, that is, it doesn't change with  $x$  anymore. Under those conditions,  $\partial\Psi_2/\partial x = 0$  and

$$\frac{\partial\Psi_{total}}{\partial x} = \frac{\partial\Psi_1}{\partial x} = \frac{(k_1 \cos[k_1 x])}{(1 + f(k_1(x - x_0)))^2} + \frac{(-k_1 \sin[k_1 x])}{(1 + f(k_1(x - x_0)))} = 0 \quad (99)$$

In the asymptotic regime, the next  $x$  will be equal to the prior  $x_0$ , thus the saturation angle will be such that:

$$\sin(k_1 x) = \cos(k_1 x)$$

or

$$k_1 x = 45^\circ \quad (100)$$

A conclusion can be derived if one considers planar waves propagating along  $R$  and the position of the next  $x$  points to a  $45^\circ$  from the  $R$  direction. This is the reason why the speed of light is the limiting speed when this paradigm is used for acceleration of masses.

That is also the reason why a Lorentz transformation and Strict Relative were created. Without the Quantum Lagrangian Principle and this proposed Universe Topology, the requirement of an accumulation point at  $45^\circ$  can only be achieved using a hyperbolic  $XYZ\Phi$  spacetime. The Hypergeometrical Universe Theory not only provides the reason why things move but also provides the reason why they cannot be accelerated faster than the speed of light. This also provides the basis for alternative understanding of the passage of time, space dilation etc.

### 2.5.3 RELATING SPEED WITH THE PASSAGE OF TIME

Since at each de-Broglie step, the  $\Delta x$  associate with interaction depends upon the actual absolute speed (torsional of the local metric), when speeds are close to the speed of light, smaller  $\Delta x$  means slower dynamics (chemical or nuclear reaction dynamics). That in turn can be understood as slower passage of time. This means that, this theory states that the passage of time is constant. The laws of Physics are what needs change with speed.

This also means that a particle lifetime depends upon the torsion of its local metric. Nuclear energy is stored in internal rotational velocity, and thus on torsion of local metric. The effect of speed is to effectively relax the local metric, thus increasing the particle lifetime.

### 2.5.4 DERIVING THE GRAND UNIFICATION EQUATION

To calculate the value of  $x$  in general, we consider that space is relaxed at time zero to make calculations easier and take the derivative of the dilaton field with respect to  $x$  in the proximity of the probe dilator ( $x_0=0$ ) and equate it to zero.

Notice that there is no need for any rescaling (Gravitation is much weaker than Electromagnetic interaction) or physical dimensions. Under those conditions:

$$\Psi_{Total}(x) = \Psi_1(x) + \Psi_2(x) = \frac{\cos(k_1 x)}{(1 + f(k_1 x))} + \frac{N \cos(k_2 x)}{(1 + f(k_2 \cdot (x - R)))} \quad (101)$$

$$\Psi_{Total}(x) = \frac{\cos(k_1 x)}{(1 + f(k_1 x))} + \frac{N}{(1 + f(k_2 \cdot (x - R)))} \quad (102)$$

For large N.

Taking the derivative at x=0:

$$\frac{d\Psi_{Total}(x)}{dx} = -k_1 \sin(k_1 x) + \frac{N k_2}{(k_2 \cdot R)^2} = 0 \quad (103)$$

$$k_1^2 x = \frac{N}{k_2 \cdot R^2} \quad (104)$$

$$x = \frac{N \lambda_1^2 \lambda_2}{(2\pi)^3 R^2} \quad (105)$$

since

$$\frac{df(k_1 x)}{dx} = 0 \quad (106)$$

$$\frac{df(k_2 \cdot (x - R))}{dx} = k_2 \quad (107)$$

$$R \gg \lambda_1 \quad (108)$$

Where sine function was expanded into  $k_1 \cdot x$ .

2.5.4.1 GRAND UNIFICATION EQUATION:

$$x = \frac{N \lambda_1^2 \lambda_2}{(2\pi)^3 R^2} \quad (105)$$



Let's define  $\tan(\alpha_1)$  as:

$$\tan(\alpha_1) = \frac{x}{\lambda_1} \delta = \frac{\left( \lambda_1 \lambda_2 \left( \frac{N}{\chi} \right) \right)}{(2\pi)^3 R^2} \delta \quad (109)$$

$\delta$  is a parameter related to the type of interaction and the elasticity of space. Now we can calculate the acceleration as:

$$acceleration = c^2 \frac{d\tan(\alpha_1)}{dr} = \frac{c^2 \tan(\alpha_1)}{\lambda_1} = \frac{c^2 \lambda_2 \left( \frac{N}{\chi} \right)}{(2\pi)^3 R^2} \delta \quad (110)$$

Now we can calculate the electrostatic force between two 1 Kg3D mass of EFD with R=1 meter. (N/χ)= Number of EFD per 1 Kg4D.

Remember that we are using a mapping

$$\left( \frac{Kg4D}{Kg3D} \right) = 1 \quad (111)$$

By allowing the actual 4DMass of a dilator to be given by χ a.m.u..

$$F_{Electrostatic} = 1 \text{ Kg3D} * acceleration = \frac{c^2 \lambda_2 \left( \frac{N}{\chi} \right)^2}{(2\pi)^3} \delta \left( \frac{1}{Kg3D} \right) \left( \frac{Kg3D}{meter} \right)^2 \quad (112)$$

$$F_{Electrostatic} = G_{Electrostatic}^{4D} \left( \frac{Kg3D}{meter} \right)^2 \quad (113)$$

$$G_{Electrostatic}^{4D} = \frac{c^2 \lambda_2 \left( \frac{N}{\chi} \right)^2}{(2\pi)^3} \delta \left( \frac{1}{Kg3D} \right) \quad (114)$$

Comparing  $G_{Electrostatic}^{4D}$  with the previous calculated value using Gauss' Law:

$$\frac{1}{4 \pi \epsilon_0} e^2 \left( \frac{N}{\chi} \right)^2 \frac{1}{(Kg3D)^2} = \frac{c^2 \lambda_2 \left( \frac{N}{\chi} \right)^2}{(2\pi)^3} \delta \left( \frac{1}{Kg3D} \right) \quad (115)$$

For electrostatics, we will assign  $\delta = 1$ , that is, the local surface is totally twisted by the dilaton field. Solving the equation for  $\lambda_2$ :

$$\lambda_2 = \frac{2\pi^2 e^2}{\epsilon_0 c^2 (Kg3D)} = 6.36737 * 10^{-43} \quad (116)$$

$\lambda_2$  is the Compton wavelength of 1000\*Avogadro of 1 4D a.m.u dilator. Subsequently, we will hide the Kg3D unit for convenience, but that unit is necessary to recover  $\epsilon_0$  proper units.

For the case of a 4DMass of 1 a.m.u., one can calculate the effective electron 4DMass :

$$\frac{\lambda_2}{\frac{\lambda_1(a.m.u.)}{1000 * Avogadro}} = \frac{\left(\frac{1}{\chi}\right)}{1} \quad (117)$$

$$\lambda_1 = \frac{h}{c a.m.u.} = 1.3205 \_femtometer \quad (118)$$

$$\chi = \frac{\lambda_1}{\lambda_2 * 1000 * Avogadro} = 1.70918 \text{ a.m.u.} \quad (119)$$

This result is the reasoning behind equation (65):

$$\lambda_{14D}^{EFD} = \frac{h}{c \chi \left( \frac{m_{4D}}{HydrogenMass} \right)} = \left( \frac{HydrogenMass}{\chi} \right) \frac{h}{c m_{4D}} \quad (120)$$

$$\lambda_{14D}^{EFD} = \frac{0.292731h}{c m_{4D}} = \frac{h^{GE}}{c m_{4D}} = 3.83507 * 10^{-16} \text{ meters} \quad (121)$$

$$h^{GE} = 0.292731h \quad (122)$$

where  $m_{4D}$ =HydrogenMass for a EFD (electron or proton).  $h^{GE}$  is the effective Planck's Constant for Hypervolumetric Dilaton Waves (see equation 65). Since the dilaton field for Gravitation is not the same as the 3D de-Broglie matter wavelength, one might consider using equation (65) for both EFD and GFD, thus

$$\frac{\lambda_{14D}^{EFD}}{\lambda_{14D}^{GFD}} = 2 \quad (123)$$

## 2.5.5 DE-BROGLIE STEP CHARACTERIZATION

To calculate the time for GFD (us and the whole Universe) to traverse a de-Broglie step:

$$\lambda_1 = 0.292731h/(m.c) = 1.91753 * 10^{-16} \text{ meters where } m = 2 \text{ HydrogenMass}$$

$$t_1 = \lambda_1/c = 6.39621 * 10^{-25} \text{ seconds}$$

is the time to traverse a de-Broglie step of  $\lambda_1= 0.191753$  femtometers

### 2.5.6 EFFECTIVE 4D MASSES

Let's write our expression for the vacuum permittivity  $\epsilon_0$ :

$$\epsilon_0 = \frac{2\pi^2 e^2}{\lambda_2 c^2 (Kg3D)} \quad (124)$$

Let's define  $\delta$  such that the angle is measure as related to Gravitation:

$$\delta = \frac{\lambda_1}{R_0} \xi \quad (125)$$

Next we will explore a scenario where the space elasticity is considered constant throughout the Universe life. Let's analyze  $\delta$  for Gravitation for 1 Kg4D of dilators.

$$F_{Gravitational} = G \left( \frac{1}{2\chi} \right)^2 = \frac{\left( c^2 \lambda_2 M \left( \frac{N}{2\chi} \right)^2 \right) \lambda_1}{(2\pi)^3 R_0} \xi \quad (126)$$

$$\xi = \frac{(2\pi)^3 GR_0}{c^2 \lambda_2 N^2 \lambda_1} = 283,087 \quad (127)$$

G can be written as:

$$G(R) = \frac{c^2 \lambda_2 N^2 \lambda_1}{(2\pi)^3 R} \xi \quad (128)$$

Let's calculate the gravitational force acting on a mass m:

$$F = m a = m c^2 \frac{\partial \tan(\alpha_0)}{\partial \lambda_1} = (m c^2) \frac{\delta x}{\lambda_1^2} = m \frac{c^2 \delta}{\lambda_1^2} x = m (2 \pi f)^2 x \quad (129)$$

Thus, the natural frequency of gravitational waves is:

$$f = \frac{1}{2\pi} \sqrt{\frac{c^2 \delta}{\lambda_1^2}} = \frac{c^2}{2\pi \lambda_1} \sqrt{\frac{\lambda_1 \xi}{R_0}} = 111,101Hz \quad (130)$$

Notice that this is not dependent upon any masses, only dependent upon the assumption of constant space elasticity. That should be the best frequency to look for or to create gravitational waves. Of course, Hubble red shift considerations should be used to determine the precise frequency from a specific region of the universe. The complete Gravitatostatic equation is given by:

$$F_{Gravitational} = \left\{ \frac{c^2 \lambda_2 \left( \frac{N}{\chi} \right)^2}{(2\pi)^3} \frac{\lambda_1}{R_0} \xi \right\} \frac{(m1 * m2)}{R^2} \quad (131)$$

Later we will derive a Gyrogravitational version of this equation.

### 2.5.7 GRAND UNIFICATION SUPERSYMMETRY

As the dimensional age of the universe becomes smaller, the relative strength of gravitation interaction increases. Conversely, one expects that as the universe expands gravity will become weaker and weaker. This and the four-dimensional light speed expanding hyperspherical universe topology explain the acceleration of expansion without the need of anti-gravitational dark matter.

We can now calculate the radius of the Universe when Gravitational and Electrostatic forces were equal. Just make  $\delta=1$  and calculate  $R_0$ :

$$\delta = \frac{\lambda_1}{R_0} \xi \quad (132)$$

$$R_0 = \xi \lambda_1 = 283,087 \lambda_1 = 1.08566 * 10^{-10} = 1.08566 \text{ Angstroms} \quad (133)$$

$$t_0 = \frac{R_0}{c} = 3.62137 * 10^{-19} \text{ seconds} \quad (134)$$

Thus, when  $R_0$  was smaller than 283,087 times  $\lambda_1$  (at 3.6E-19s into the Universe life), gravitational and electromagnetic interactions had equal strength. They were certainly indistinguishable when the radius of the universe was one de-Broglie wavelength long. This section is called Grand unification supersymmetry, because condition in equation (132) plays the role of the envisioned group theoretical supersymmetry of the grand unification force. Of course, it has a geometrical interpretation. At that exact radius, an elastic spring constant of the fabric of space allows for a change in the local normal such that it becomes parallel to the redirection of k-vector of a freely moving dilator.

### 2.5.8 QUANTUM GRAVITY

Quantum aspects can be recovered by not using fast oscillation approximation. It is also important to notice that equations (102) and (103) can be used to calculate the interaction between any particles or to perform quantum mechanical calculations in a manner similar to molecular dynamic simulations. The quantum character is implicit in the de-Broglie wavelength stepwise quantization. It is also relativistic as it will become clear when one analyzes magnetism next.

## 2.5.9 MAGNETIC INTERACTION

### 2.5.9.1 THE DERIVATION OF THE BIOT-SAVART LAW

Let's consider two wires with currents  $i_1$  and  $i_2$  separated by a distance  $R$ . Let's consider  $i_2$  on the element of length  $dl_2$  as the result of a moving charge of mass of  $1\text{Kg}4\text{D}$  of electromagnetic fundamental dilators. This is done to obtain the correct scaling factor.

Without loss of generality, let's consider that the distance between the two elements of current is given by:

$$r_0 = \begin{bmatrix} 0 \\ 0 \\ 0 \\ R \end{bmatrix} \text{ and } R = \frac{R}{\sqrt{3}} \begin{bmatrix} 1 \\ 1 \\ 1 \\ 0 \end{bmatrix} \text{ and } \hat{R} = \frac{1}{\sqrt{3}} \begin{bmatrix} 1 \\ 1 \\ 1 \\ 0 \end{bmatrix} \quad (135)$$

The velocities are:

$$V_1 = \begin{pmatrix} v_1\alpha_1 \\ v_1\beta_1 \\ v_1\gamma_1 \\ c \end{pmatrix} \text{ and } V_2 = \begin{pmatrix} v_2\alpha_2 \\ v_2\beta_2 \\ v_2\gamma_2 \\ c \end{pmatrix} \quad (136)$$

Since one expects that the motion of particle 2 will produce a drag on the particle 1 along particle 2 direction of motion. Particle 1 is located at position  $R \begin{pmatrix} 0 & 0 & 0 & 1 \end{pmatrix}$ , just prior to the next de-Broglie Universe expansion step.

Particle 2 was placed at position  $\frac{R}{\sqrt{3}} \begin{pmatrix} 1 & 1 & 1 & 0 \end{pmatrix}$  and traveling at speed

$V_2 = \begin{pmatrix} v_2\alpha_2 & v_2\beta_2 & v_2\gamma_2 & c \end{pmatrix}$ . The retarded potential time difference is  $\frac{R}{c} = \frac{\sqrt{2}R}{\sqrt{2}c}$  just to

remind us that the actual light speed is  $\sqrt{2}c$  and it traverses  $\sqrt{2}R$  in a 4D spatial manifold at 45 degrees. The direction of the drag will be:

$$\hat{r} + \frac{\vec{V}_2}{c} = \frac{1}{N_{Factor}} \left( \begin{pmatrix} \frac{1}{\sqrt{3}} \\ \frac{1}{\sqrt{3}} \\ \frac{1}{\sqrt{3}} \\ -1 \end{pmatrix} + \begin{pmatrix} \frac{v_2\alpha_2}{c} \\ \frac{v_2\beta_2}{c} \\ \frac{v_2\gamma_2}{c} \\ 1 \end{pmatrix} \right) \quad (137)$$

The force will depend upon the distance defined by  $\frac{R}{\sqrt{3}} \begin{pmatrix} 1 & 1 & 1 & 0 \end{pmatrix}$ . The drag projection on reference frame of particle 1, onto that vector should be made unit such that one can properly evaluate the force modulus.

The Normalization Factor (NFactor) is given by:

$$N_{Factor} = \begin{bmatrix} \frac{1}{\sqrt{3}} & \frac{1}{\sqrt{3}} & \frac{1}{\sqrt{3}} & 1 \end{bmatrix} \begin{bmatrix} 1 & 0 & 0 & -\frac{v_1}{c}\alpha_1 \\ 0 & 1 & 0 & -\frac{v_1}{c}\beta_1 \\ 0 & 0 & 1 & -\frac{v_1}{c}\gamma_1 \\ \frac{v_1}{c}\alpha_1 & \frac{v_1}{c}\beta_1 & \frac{v_1}{c}\gamma_1 & 1 \end{bmatrix} \begin{pmatrix} \frac{1}{\sqrt{3}} + \frac{v_2}{c}\alpha_2 \\ \frac{1}{\sqrt{3}} + \frac{v_2}{c}\beta_2 \\ \frac{1}{\sqrt{3}} + \frac{v_2}{c}\gamma_2 \\ 0 \end{pmatrix} \quad (138)$$

$$N_{Factor} = \begin{bmatrix} \frac{1}{\sqrt{3}} + \frac{v_1}{c}\alpha_1 & \frac{1}{\sqrt{3}} + \frac{v_1}{c}\beta_1 & \frac{1}{\sqrt{3}} + \frac{v_1}{c}\gamma_1 & 1 \end{bmatrix} \begin{pmatrix} \frac{1}{\sqrt{3}} + \frac{v_2}{c}\alpha_2 \\ \frac{1}{\sqrt{3}} + \frac{v_2}{c}\beta_2 \\ \frac{1}{\sqrt{3}} + \frac{v_2}{c}\gamma_2 \\ 0 \end{pmatrix} \quad (139)$$

$$N_{Factor} = 1 + \frac{V_1 \cdot \hat{R}}{c} + \frac{V_2 \cdot \hat{R}}{c} + \frac{V_1 \cdot V_2}{c^2} \quad (140)$$

This normalization factor will be deployed at the end of the calculation. If it is deployed at the beginning, there wouldn't be any change in phase due to interaction.

Simple geometry (see Fig. 29) in 4D reveals that:

$$\alpha = \text{atan} \left( \frac{v_2 \alpha_2 \left( \frac{R}{c} \right)}{R} \right) = \text{atan} \left( \frac{v_2 \alpha_2}{c} \right) \quad (141)$$

$$\cos(\alpha') = \cos\left(-\frac{\pi}{4} + \alpha\right) = \cos\left(\frac{\pi}{4}\right)\cos(\alpha) + \sin(\alpha)\sin\left(\frac{\pi}{4}\right) \quad (142)$$

$$\cos(\alpha') = \frac{\sqrt{2}\cos(\alpha)}{2}[1 + \tan(\alpha)] \quad (143)$$

$$\cos(\alpha') \approx 1 + \frac{v_2\alpha_2}{c} \quad (144)$$

The last part of the identity above shows the position where Particle would be (referred from Particle 2) after the Universe expanded by R radially. This represents the maximum drag possible where Particle 1 would imitate Particle 2. The force calculation allows for Particle 1 to be pushed into that direction. The amount of drag is related to the intensity of the force between dilators.

After one de-Broglie cycle:

$$r_0 = \begin{bmatrix} 0 \\ 0 \\ 0 \\ R \end{bmatrix} \text{ and } (r - r_0) = \Delta \begin{pmatrix} \left(\frac{1}{\sqrt{3}} + \frac{v_2}{c}\alpha_2\right) \\ \left(\frac{1}{\sqrt{3}} + \frac{v_2}{c}\beta_2\right) \\ \left(\frac{1}{\sqrt{3}} + \frac{v_2}{c}\gamma_2\right) \\ 0 \end{pmatrix} \quad (145)$$

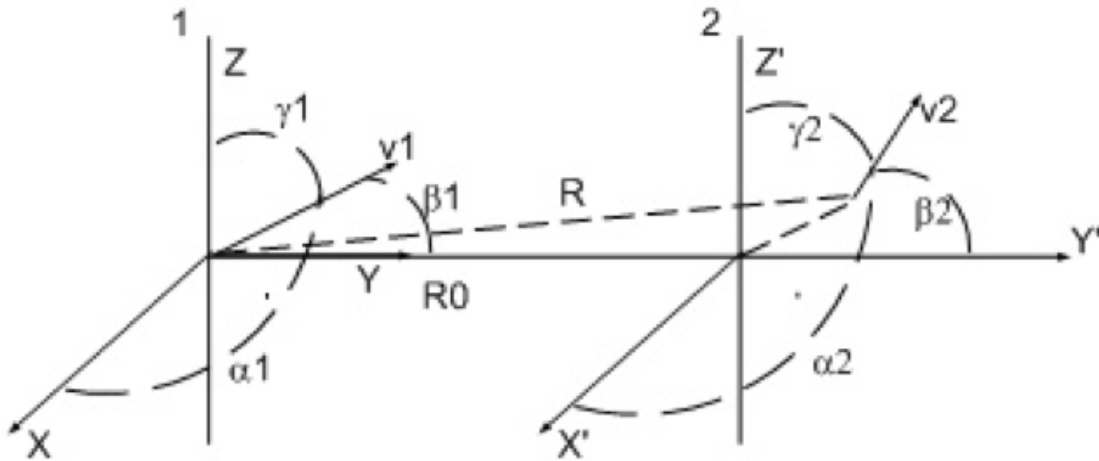

Figure 29: Derivation of Biot-Savart law using spacetime waves. This showcase the geometry associated with the two interacting elements of current.

In the case of currents, the velocities are not relativistic and one can make the following approximations to the five-dimensional rotation matrix or metric:  $\cosh(\alpha_i) \approx 1$  and  $\sinh(\alpha_i) \approx v_i/c$  where  $v_i$  is the velocity along the axis  $i$ . The k-vectors for the two electrons on the static reference frame are given by:

$$k_1 = \frac{2\pi}{\lambda_1} \begin{bmatrix} \frac{1}{\sqrt{3}} & \frac{1}{\sqrt{3}} & \frac{1}{\sqrt{3}} & 1 \\ 1 & 0 & 0 & -\frac{v_1}{c}\alpha_1 \\ 0 & 1 & 0 & -\frac{v_1}{c}\beta_1 \\ 0 & 0 & 1 & -\frac{v_1}{c}\gamma_1 \\ \frac{v_1}{c}\alpha_1 & \frac{v_1}{c}\beta_1 & \frac{v_1}{c}\gamma_1 & 1 \end{bmatrix} \quad (146)$$

$$k_1 = \frac{2\pi}{\lambda_1} \begin{bmatrix} \frac{1}{\sqrt{3}} + \frac{v_1}{c}\alpha_1 & \frac{1}{\sqrt{3}} + \frac{v_1}{c}\beta_1 & \frac{1}{\sqrt{3}} + \frac{v_1}{c}\gamma_1 & 1 - \frac{v_1}{c}\alpha_1 - \frac{v_1}{c}\beta_1 - \frac{v_1}{c}\gamma_1 \\ \frac{1}{\sqrt{3}} + \frac{v_1}{c}\alpha_1 & \frac{1}{\sqrt{3}} + \frac{v_1}{c}\beta_1 & \frac{1}{\sqrt{3}} + \frac{v_1}{c}\gamma_1 & 1 - \frac{v_1}{c}\alpha_1 - \frac{v_1}{c}\beta_1 - \frac{v_1}{c}\gamma_1 \end{bmatrix} \quad (147)$$

Similarly:

$$k_2 = \frac{2\pi}{\lambda_2} \begin{bmatrix} \frac{1}{\sqrt{3}} & \frac{1}{\sqrt{3}} & \frac{1}{\sqrt{3}} & 1 \\ 1 & 0 & 0 & -\frac{v_2}{c}\alpha_2 \\ 0 & 1 & 0 & -\frac{v_2}{c}\beta_2 \\ 0 & 0 & 1 & -\frac{v_2}{c}\gamma_2 \\ \frac{v_2}{c}\alpha_2 & \frac{v_2}{c}\beta_2 & \frac{v_2}{c}\gamma_2 & 1 \end{bmatrix} \quad (148)$$

$$k_2 = \frac{2\pi}{\lambda_2} \begin{bmatrix} \frac{1}{\sqrt{3}} + \frac{v_2}{c}\alpha_2 & \frac{1}{\sqrt{3}} + \frac{v_2}{c}\beta_2 & \frac{1}{\sqrt{3}} + \frac{v_2}{c}\gamma_2 & 1 + \frac{v_2}{c}\alpha_2 - \frac{v_2}{c}\beta_2 - \frac{v_2}{c}\gamma_2 \\ \frac{1}{\sqrt{3}} + \frac{v_2}{c}\alpha_2 & \frac{1}{\sqrt{3}} + \frac{v_2}{c}\beta_2 & \frac{1}{\sqrt{3}} + \frac{v_2}{c}\gamma_2 & 1 + \frac{v_2}{c}\alpha_2 - \frac{v_2}{c}\beta_2 - \frac{v_2}{c}\gamma_2 \end{bmatrix} \quad (149)$$

The wave intensities at  $\vec{r}$  are:

$$\Psi_1(x, y, z, r, \Phi) = \frac{\cos(k_1 \cdot (r - r_0))}{(1 + f(k_1 \cdot (r - r_0)))} \quad (150)$$

$$\Psi_2(x, y, z, r, \Phi) = \frac{N \cdot \cos(k_2 \cdot (r - R))}{(1 + f(k_2 \cdot (r - R)))} \cong \frac{N}{(1 + f(k_2 \cdot (r - R)))} \quad (151)$$

Where  $N = 1000$  Avogadro/ $\chi$ ,  $\lambda_1 =$  de-Broglie wavelength of a a.m.u (atomic mass unit) particle,  $\lambda_2 =$  de-Broglie wavelength of a 1Kg4D particle =  $\lambda_1/N$ .



To solve this optimization problem, we will find that solves this equation:

$$\frac{d\Psi_1(\Delta)}{d\Delta} = \nabla\Psi_2(x, y, z, r, \Phi) \cdot \hat{R} \quad (152)$$

this is equivalent to just summing up the rows in the gradient vector on the right-side equation.

Now one can calculate:

$$k_1 \cdot (r - r_0) = \left( \frac{2\pi\Delta}{\lambda_1} \right) \left( 1 + \frac{V_1 \cdot \hat{R}}{c} + \frac{V_2 \cdot \hat{R}}{c} + \frac{V_1 \cdot V_2}{c^2} \right) \quad (153)$$

$$\frac{d(k_1 \cdot (r - r_0))}{d\Delta} = \left( \frac{2\pi}{\lambda_1} \right) \left( 1 + \frac{V_1 \cdot \hat{R}}{c} + \frac{V_2 \cdot \hat{R}}{c} + \frac{V_1 \cdot V_2}{c^2} \right) \quad (154)$$

$$\hat{R} = \frac{1}{\sqrt{3}} \begin{bmatrix} \hat{i} & \hat{j} & \hat{k} \end{bmatrix} \quad (155)$$

where  $x[4]=0$  because  $\lambda_1$  refers to the dilator wavelength which adjusts itself to match the de-Broglie step.

$$\nabla f(k_1 \cdot (r - r_0)) = 0 \text{ due to } |k_1 \cdot (r - r_0)| < < 2\pi \quad (156)$$

Similarly:

$$k_2 \cdot (r - R) = \frac{2\pi}{\lambda_1} \left[ \left( \frac{1}{\sqrt{3}} + \frac{v_2}{c} \alpha_2 \right) \left( \frac{1}{\sqrt{3}} + \frac{v_2}{c} \beta_2 \right) \left( \frac{1}{\sqrt{3}} + \frac{v_2}{c} \gamma_2 \right) \left( 1 - \frac{v_2}{c} \alpha_2 - \frac{v_2}{c} \beta_2 - \frac{v_2}{c} \gamma_2 \right) \right] X \quad (157)$$

$$X = \begin{pmatrix} r \left( \frac{1}{\sqrt{3}} + \frac{v_2}{c} \alpha_2 \right) - \frac{R}{\sqrt{3}} \\ r \left( \frac{1}{\sqrt{3}} + \frac{v_2}{c} \beta_2 \right) - \frac{R}{\sqrt{3}} \\ r \left( \frac{1}{\sqrt{3}} + \frac{v_2}{c} \gamma_2 \right) - \frac{R}{\sqrt{3}} \\ 0 \end{pmatrix} \quad (158)$$

$$k_2 \cdot (r - R) \approx \frac{2\pi R}{\lambda_2} \left( 1 + \frac{V_2 \cdot \hat{R}}{c} \right) \quad (159)$$

where  $x[4]=0$  because  $\lambda_2$  is  $1/N$  of  $\lambda_1$  and thus there is always a very close  $r$  that matches a  $2\pi n$  condition. And:

$$\nabla f(k_2 \cdot (r - R)) \equiv \nabla \left( \frac{2\pi}{\lambda_2} \left[ \left( \frac{1}{\sqrt{3}} + \frac{v_2}{c} \alpha_2 \right) \left( \frac{1}{\sqrt{3}} + \frac{v_2}{c} \beta_2 \right) \left( \frac{1}{\sqrt{3}} + \frac{v_2}{c} \gamma_2 \right) \left( 1 - \frac{v_2}{c} \alpha_2 - \frac{v_2}{c} \beta_2 - \frac{v_2}{c} \gamma_2 \right) \right] X \right) \quad (160)$$

$$X = \begin{pmatrix} \frac{x}{\sqrt{3}} - \frac{R}{\sqrt{3}} \\ \frac{y}{\sqrt{3}} - \frac{R}{\sqrt{3}} \\ \frac{z}{\sqrt{3}} - \frac{R}{\sqrt{3}} \\ 0 \end{pmatrix} \nabla(f(k_2.(r-R)).\hat{R}) = \frac{2\pi}{\lambda_2} \left(1 + \frac{V_2.\hat{R}}{c}\right) \quad (161)$$

Hence:

$$\nabla\Psi_1(\Delta,\Phi).\hat{R} = -\frac{\nabla(k_1.(r-r_0))}{(1+f(k_1.(r-r_0)))} \sin(k_1.(r-r_0)) \cong -k_1.(r-r_0) \frac{d(k_1.(r-r_0))}{d\Delta} \quad (162)$$

$$\nabla\Psi_1(\Delta,\Phi).\hat{R} = -\left(\frac{2\pi}{\lambda_1}\right)^2 \left(1 + \frac{V_1.\hat{R}}{c} + \frac{V_2.\hat{R}}{c} + \frac{V_1.V_2}{c^2}\right)^2 \Delta \quad (163)$$

$$\nabla\Psi_2(x,y,z,r,\Phi).\hat{R} = -\frac{N.\nabla(k_2.(r-R))}{\left(\frac{2\pi}{\lambda_2}\left(1 + \frac{V_2.\hat{R}}{c}\right)R\right)^2} = -\frac{N\lambda_2}{2\pi} \frac{\left(1 + \frac{V_2.\hat{R}}{c}\right)}{\left(1 + \frac{V_2.\hat{R}}{c}\right)^2} \frac{1}{R^2} \quad (164)$$

$$\nabla\Psi_2(x,y,z,r,\Phi).\hat{R} \cong -\frac{N\lambda_2}{2\pi R^2 \left(1 + \frac{V_2.\hat{R}}{c}\right)} \quad (165)$$

Here we calculate  $\Delta$  and replace it with  $\frac{\Delta}{NFactor}$ ,

$$\frac{\Delta}{NFactor} = \frac{N\lambda_1^2\lambda_2}{(2\pi)^3 R^2} \frac{1}{\left(1 + \frac{V_1.\hat{R}}{c} + \frac{V_2.\hat{R}}{c} + \frac{V_1.V_2}{c^2}\right)^2 \left(1 + \frac{V_2.\hat{R}}{c}\right)} \quad (166)$$

$$\Delta = \frac{N\lambda_1^2\lambda_2}{(2\pi)^3 R^2} \frac{1}{\left(1 + \frac{V_1.\hat{R}}{c} + \frac{V_2.\hat{R}}{c} + \frac{V_1.V_2}{c^2}\right) \left(1 + \frac{V_2.\hat{R}}{c}\right)} \quad (167)$$

$$\Delta \equiv \frac{N\lambda_1^2\lambda_2}{(2\pi)^3 R^2} \left\{ 1 - \frac{V_1 \cdot \hat{R}}{c} + \frac{(V_1 \cdot \hat{R})(V_2 \cdot \hat{R}) - V_1 \cdot V_2}{c^2} \right\} \quad (168)$$

Now we will start considering attraction or repulsion components. Negative contributions are repulsion. Positive ones are attraction. In the analysis, we should consider electron-electron and electron-nuclei interactions, that is, to derive Biot-Savart Law from first principles, we should consider the dilaton waves of all components of the wire and not only the electrons. The force acting upon wire 1 is due to e1-e2 repulsion, e1-p2 attraction, p1-e2 attraction, p1-p2 repulsion, that is, there are four force components acting upon wire 1. The same is valid for wire 2.

Similarly:

$$\Delta_{ee} = -\frac{N\lambda_1^2\lambda_2}{(2\pi)^3 R^2} \left( 1 - \frac{V_1 \cdot \hat{R}}{c} + \frac{(V_1 \cdot \hat{R})^2 + (V_2 \cdot \hat{R})^2 + (V_1 \cdot \hat{R})(V_2 \cdot \hat{R}) - V_1 \cdot V_2}{c^2} \right) \quad (169)$$

$$\Delta_{ep} = \frac{N\lambda_1^2\lambda_2}{(2\pi)^3 R^2} \left( 1 - \frac{V_1 \cdot \hat{R}}{c} + \frac{(V_1 \cdot \hat{R})^2}{c^2} \right) \text{ since } V_2 = 0 \quad (170)$$

$$\Delta_{pe} = \frac{N\lambda_1^2\lambda_2}{(2\pi)^3 R^2} \left( 1 + \frac{(V_2 \cdot \hat{R})^2}{c^2} \right) \text{ since } V_1 = 0 \quad (171)$$

$$\Delta_{pp} = -\frac{N\lambda_1^2\lambda_2}{(2\pi)^3 R^2} (1) \text{ since } V_1 = V_2 = 0 \quad (172)$$

$$\Delta_{total} = \Delta_{ee} + \Delta_{ep} + \Delta_{pe} + \Delta_{pp} = \frac{N\lambda_1^2\lambda_2}{(2\pi)^3 R^2} \frac{(V_1 \cdot \hat{R})(V_2 \cdot \hat{R}) - V_1 \cdot V_2}{c^2} \quad (173)$$

Where p stands for proton and e for electron.

$$r = \frac{N\lambda_1^2\lambda_2}{(2\pi)^3} \left( \frac{V_2 \cdot \hat{R}}{c} \frac{V_1 \cdot \hat{R}}{c} - \frac{V_1 \cdot V_2}{c^2} \right) \frac{\hat{R}}{R^2} \quad (174)$$

Using  $a \times (b \times c) = b(a \cdot c) - c(a \cdot b)$  :

$$r = \frac{N\lambda_1^2\lambda_2}{(2\pi)^3 c^2} (V_1 \otimes (V_2 \otimes \hat{R})) \frac{\hat{R}}{R^2} \quad (175)$$

The number of dilators can be  $1000 * \text{Avogadro} / \chi$  for Kg4D or Kg3D, or  $1/e$  for a Coulomb:

The force between two 1 Kg3D dilators separated by 1 meter is given by:

$$F = m_{03D} c^2 \frac{d \tan(\alpha_\tau)}{d\tau} = (Kg3D) \left( \frac{N}{\chi} \right) c^2 \frac{r}{\lambda_1^2} \quad (176)$$

$$F = \left( \frac{N}{\chi} \right)^2 \frac{\lambda_2}{(2\pi)^3 (Kg3D)} (V_1 \otimes (V_2 \otimes \hat{R})) \frac{(Kg3D)^2}{(meter)^2} \quad (177)$$

To scale this force into the force between two Coulomb charges traveling with velocities  $v_1$  and  $v_2$  one just have to multiply the equation by  $(1C/Ne)^2$ :

$$F = \left( \frac{1Coulomb}{e} \right) c^2 \frac{r}{\lambda_1^2} = \left( \frac{1Coulomb}{e} \right)^2 \frac{\lambda_2 v_1 v_2}{(2\pi)^3} \left( (dl_1 \otimes (dl_2 \otimes \hat{R})) \right) \frac{\hat{R}}{R^2} = \left( \frac{1Coulomb}{e} \right)^2 \frac{\lambda_2 j_1 j_2 (Kg3D)}{(2\pi)^3 e^2} \left( (dl_1 \otimes (dl_2 \otimes \hat{R})) \right) \frac{\bar{R}}{R^3} \quad (178)$$

The Biot-Savart law can be written as:

$$dF = \frac{\mu_0 I_1 I_2}{4\pi} \frac{(dl_1 dl_2)}{|\vec{x}_{12}|^3} \vec{x}_{12} \quad (179)$$

Comparing the two equations one obtains:

$$\frac{\mu_0}{4\pi} = \frac{\lambda_2 (1Kg3D)}{(2\pi)^3 e^2} \quad (180)$$

Thus

$$\mu_0 = \frac{\lambda_2 (Kg3D)}{2\pi^2 e^2} \quad (181)$$

Without that extra unit (Kg3D),  $\mu_0$  will not have the appropriate units. The same is valid for  $\epsilon_0$ .

From equation (124)

$$\epsilon_0 = \frac{2\pi^2 e^2}{\lambda_2 c^2 (Kg3D)} \quad (182)$$

Thus

$$\mu_0 \epsilon_0 = \frac{\lambda_2 (Kg3D)}{2\pi^2 e^2} \frac{2\pi^2 e^2}{\lambda_2 c^2 (Kg3D)} = \frac{1}{c^2} \quad (183)$$

Thus one recovers the relationship between  $\epsilon_0$  and  $\mu_0$ . We recovered the Biot-Savart law for infinitesimal elements of current. This was achieved by considering the many contributions of positive and negative center charges and using the low velocity approximation. All dilators contribute to electromagnetism and not just electrons.

Within a Tokamak Nuclear Fusion device, currents are both positive and negative (hot plasma) and velocities are relativistic. Under these conditions one should use the non-approximated first

half identity from equation

$$\Delta = \frac{N\lambda_1^2\lambda_2}{(2\pi)^3 R^2} \frac{1}{\left(1 + \frac{V_1 \cdot \hat{R}}{c} + \frac{V_2 \cdot \hat{R}}{c} + \frac{V_1 \cdot V_2}{c^2}\right) \left(1 + \frac{V_2 \cdot \hat{R}}{c}\right)} \quad (184)$$

$$\frac{\Delta}{NF} = \frac{N\lambda_1^2\lambda_2}{(2\pi)^3 R^2} \frac{1}{\left(1 + \frac{V_1 \cdot \hat{R}}{c} + \frac{V_2 \cdot \hat{R}}{c} + \frac{V_1 \cdot V_2}{c^2}\right)^2 \left(1 + \frac{V_2 \cdot \hat{R}}{c}\right)} \quad (185)$$

$$\Delta = \frac{N\lambda_1^2\lambda_2}{(2\pi)^3 R^2} \frac{1}{\left(1 + \frac{V_1 \cdot \hat{R}}{c} + \frac{V_2 \cdot \hat{R}}{c} + \frac{V_1 \cdot V_2}{c^2}\right) \left(1 + \frac{V_2 \cdot \hat{R}}{c}\right)} \quad (186)$$

$$\Delta \equiv \frac{N\lambda_1^2\lambda_2}{(2\pi)^3 R^2} \left\{ 1 - \frac{V_1 \cdot \hat{R}}{c} + \frac{(V_1 \cdot \hat{R})(V_2 \cdot \hat{R}) - V_1 \cdot V_2}{c^2} \right\} \quad (187)$$

The force between two 1 Kg4D dilators is given by:

$$F = m_{03D} c^2 \frac{d \tan(\alpha_\tau)}{d\tau} = (Kg3D) \left(\frac{N}{\chi}\right) c^2 \frac{r}{\lambda_1^2} \quad (188)$$

$$F = (Kg3D) \left(\frac{N}{\chi}\right)^2 \frac{\lambda_2}{(2\pi)^3 R^2} \frac{1}{\left(1 + \frac{V_1 \cdot \hat{R}}{c} + \frac{V_2 \cdot \hat{R}}{c} + \frac{V_1 \cdot V_2}{c^2}\right) \left(1 + \frac{V_2 \cdot \hat{R}}{c}\right)} \hat{R} \quad (189)$$

To scale this force into the force between two Coulomb charges traveling with velocities  $v_1$  and

$v_2$  one just has to multiply the equation by  $\left(\frac{1C}{Ne}\right)^2$ :

$$F = \frac{\mu_0 c^2 C_1 C_2}{4\pi} \frac{1}{\left(1 + \frac{V_1 \cdot \hat{R}}{c} + \frac{V_2 \cdot \hat{R}}{c} + \frac{V_1 \cdot V_2}{c^2}\right) \left(1 + \frac{V_2 \cdot \hat{R}}{c}\right)} \frac{\hat{R}}{R^2} \quad (190)$$

$$F = \frac{C_1 C_2}{4\pi \epsilon_0} \frac{1}{\left(1 + \frac{V_1 \cdot \hat{R}}{c} + \frac{V_2 \cdot \hat{R}}{c} + \frac{V_1 \cdot V_2}{c^2}\right) \left(1 + \frac{V_2 \cdot \hat{R}}{c}\right)} \frac{\hat{R}}{R^2} \quad (191)$$

Where  $C_1$  and  $C_2$  are charges traveling at  $v_1$  and  $v_2$  and  $c$  is the speed of light. The asymmetry with respect to  $v_2$  is not lost in our considerations. Now, we will not dwell on it since the small velocity approximation matched Biot-Savart Law and we also recovered the Gerber<sup>20,21</sup> Potential

(thus recovering the Mercury Perihelion Precession Measurements). In addition, there are experimental results by NASA (EM Drive) that indicate the possibility of propulsion based on electromagnetic fields (moving charges) and that might be related to these results.

## 2.5.10 GYROGRAVITATION-ELECTROMAGNETISM UNIFICATION

Similarly, one can derive the Gravitational Biot-Savart equation by simple analogy to our derivation of the Gravitation Law.

The limit with zero velocity independent term corresponds to the steady state gravitational field (Newton's Law).

$$F_{Gravitational} = \left[ \left( \frac{N}{\chi} \right) \frac{\lambda_1 c^2}{(2\pi)^3} \frac{\lambda_1}{R_0} \xi \right] M_1 M_2 \frac{1}{\left( 1 + \frac{V_1 \cdot \hat{R}}{c} + \frac{V_2 \cdot \hat{R}}{c} + \frac{V_1 \cdot V_2}{c^2} \right) \left( 1 + \frac{V_2 \cdot \hat{R}}{c} \right)} \frac{\hat{R}}{R^2} \quad (192)$$

$$G = \left[ \left( \frac{N}{\chi} \right) \frac{\lambda_1 c^2}{(2\pi)^3} \frac{\lambda_1}{R_0} \xi \right] \quad (193)$$

$$F_{Gravitational} = \left[ \left( \frac{N}{\chi} \right) \frac{\lambda_1 c^2}{(2\pi)^3} \frac{\lambda_1}{R_0} \xi \right] M_1 M_2 \frac{\hat{R}}{R^2} \quad (194)$$

Notice that the value of the Gravitational Constant G is inversely proportional to the 4D Radius of the Universe  $R_0$ . This means that at earlier epochs, Gravitation was stronger and at a precise time in the life of the Universe all forces had the same strength. It also means that Stellar Candles would contain smaller masses in the past than they do at later epochs. This means that current measurements of distances across the Universe based upon Stellar Candles might not work properly and indicate unreasonable large distance incompatible with the age of the Universe.

For non-zero relative speed, we obtain the Hypergeometrical Universe Law of Gravitation:

$$F = GM_1 M_2 \frac{1}{\left( 1 + \frac{V_1 \cdot \hat{R}}{c} + \frac{V_2 \cdot \hat{R}}{c} + \frac{V_1 \cdot V_2}{c^2} \right) \left( 1 + \frac{V_2 \cdot \hat{R}}{c} \right)} \frac{\hat{R}}{R^2} \quad (195)$$

$$F \cong GM_1 M_2 \frac{\hat{R}}{R^2} \left( 1 - \frac{V_1 \cdot \hat{R}}{c} + \frac{(V_1 \cdot \hat{R})^2 + (V_2 \cdot \hat{R})^2 + (V_1 \cdot \hat{R})(V_2 \cdot \hat{R}) - V_1 \cdot V_2}{c^2} \right) \quad (196)$$

Equations (190-191) express the force for two elements of charge in motion. They recover Gauss Law under conditions of rest and have identical form as equation (195). This means that a single equation describes everything we know about electrostatics, electromagnetism and gravitation.

The Force derivation uses a boundary condition where the dilator is at rest with respect to the FS. This is equivalent to say that all forces are partial derivatives with respect to R while keeping velocity constant. This is important since the force is velocity dependent. To obtain a potential from which one can calculate dynamics, one need to integrate the equation (195) with respect to R.

$$V_2(R, V_1, V_2) = \frac{GM_1}{\left(1 + \frac{V_1 \cdot \hat{R}}{c} + \frac{V_2 \cdot \hat{R}}{c} + \frac{V_1 \cdot V_2}{c^2}\right) \left(1 + \frac{V_2 \cdot \hat{R}}{c}\right)} \frac{1}{R} \quad (197)$$

This equation was derived under the regimen of weak (normal) gravitational pull. It would be easy to derive the same equation for conditions in the surroundings of a Black Hole. One would just not use the derivative approximations.

This means that there is Antigravity (weakening of Gravitation) right within the Law of Gravitation. If for a moment one sets the referential frame on body 1, thus having  $V_1=0$ , the Gravitational Force on F2 becomes:

$$F_2 = GM_1 M_2 \frac{1}{\left(1 + \frac{V_2 \cdot \hat{R}}{c}\right)^2} \frac{\hat{R}}{R^2} \approx GM_1 M_2 \frac{\hat{R}}{R^2} \left(1 - 2\left(\frac{V_2 \cdot \hat{R}}{c}\right) + 3\left(\frac{V_2 \cdot \hat{R}}{c}\right)^2 - 4\left(\frac{V_2 \cdot \hat{R}}{c}\right)^3 \dots\right) \quad (198)$$

This is a much more complex view of Gravitation and it is a view derived from a more fundamental model. It reduces to Newton's Law at zero relative velocity. This might be involved in the production of double jets in Black Holes.

## 2.6 DISCUSSION

The Hypergeometrical Universe theory non-parametrized predictions were shown to consistently reproduce the observational astronomic data better than the best current 6-parameters Friedmann- Lemaitre Cosmological Fitting. Application of this model to different region fittings yielded different set of parameters (Dark Energy/Dark Matter related parameters. That indicates that this General Relativity variant using Dark Energy as Cosmological Constant and Dark Matter as added Gravitational pull fails at large in describing the Universe.

Conversely, the reproduction of observational astronomic data by HU provides some level of support for the hypothesis that G is epoch-dependent and proportional to the inverse 4D radius and that there might be a systematic error in converting the Luminosities into distances. The scaling up of the gravitational constant G is an integral part of the Hypergeometrical Universe rationale since it is how one derives the HU Gyrogravitational Law.

This scaling up also provides support for the hypothesis of **Epoch Covariance**.

As space contracts and G increases, stars and galaxies also contract and so do their energy output ( $G(d)^{-3}$  scaling factor). This is important otherwise astronomical observations would indicate a distorted picture of weaker Supernovas contained in unusually luminous Galaxies.

Stronger gravity also means that star/galaxy formation will occur ahead of constant-G models predictions. Since HU provides a clear description of how space expands, cosmological simulations could be simplified. Gyro-gravitation and Gyro-electromagnetism will add some complexity.<sup>22</sup>

### 2.6.1 INFLUENCE OF EPOCH-DEPENDENT G ON EARTH NATURAL PROCESSES:

Gravitation influences the passage of time, but its effect for Earth gravitational strength is

$$T = \frac{T_0}{\sqrt{1 - \frac{2gR}{c^2}}} \approx T_0 \left( 1 + \frac{gR}{c^2} + \frac{3g^2R^2}{2c^4} \dots \right) = T_0 (1 + 6.95E - 11g + \dots) \quad (199)$$

During Earth's existence (4.8 billion years), the effect of an epoch-dependent G was to modify Time by an extra factor of 3.3E-10, which is negligible to all physical processes (including radioactive decay) on Earth.

### 2.6.2 INFLUENCE OF EPOCH-DEPENDENT G ON SOLAR SYSTEM CELESTIAL DYNAMICS:

Current Solar System is explained by the Great Tack, a motion of Jupiter from an outer orbit into an inner orbit and back. The Solar System is also around 5 billion years old. During this time, Gravitation decreased in strength by 50%. That means, that Jupiter could had being created from the Sun or captured by the Sun in an inner orbit. As Gravitation weakened, Jupiter would naturally move into an outer orbit. No need for a colossal collision.

In addition, stronger G during Earth life should not appreciably had effected any chemical, radioactive or biological process.

### 2.6.3 CORRELATION ON THE MICROWAVE COSMIC BACKGROUND

The homogeneity of the CMB is simply explained by the perfect symmetry of the Hypersphere.

### 2.6.7 CMB AND BAO

BAO angular diameter distance is modeled by a diffusional process having a lump of Dark Matter. That lump is responsible for the recurrence peak on 150 Mpc on the pair density mapping. HU proposes that there might be a secondary hypersphere separated by a number of de Broglie steps, perhaps as little as half a de Broglie step.

HU also proposes that that hypersphere to be made up of a net antimatter content. The reason for that hypothesis was to explain Gamma Ray Bursts. HU proposes that give enough density of matter and dark matter overlapping on a given region of the 3D space while separated by a few femtometers on the radial direction a wormhole will be created between two hyperspheres and matter annihilation in large scale can occur. After the GRBs, the remaining matter coalesced around Dark Matter (Dark Antimatter), providing the basis for the mechanisms proposed on



BAO to explain their observed secondary angular diameter distance distribution lump. HU also proposes a natural frequency of space fluctuations (111,101 Hz). That might be related to the tertiary structure of voids.

The variance of density fluctuations in the Universe might had been affected by the much stronger Gravitation at earlier epochs.

The fractions of Dark Matter, Dark Energy and Baryonic Matter derived from Friedman equations lose meaning since they were not needed to reproduce astronomical observations.

### 3. CONCLUSIONS

The Hypergeometrical Universe theory, a model that considers the interference of four-dimensional wave on the hypersurface of a hyperspherical expanding universe was introduced. The complexity of the present description of the universe in our sciences<sup>1,3,4,8,23</sup> is assigned to the fact that one is dealing with four-dimensional projections of a five-dimensional process. Our inability to realize that made the description unnecessarily complex.

These are the ingredients for a new and simple formulation of Physics:

1. A new quantum Lagrangian principle (QLP) was proposed.
2. Quantum gravity, electrostatics and electromagnetism were derived using the same equations (QLP), same framework. The theory is inherently quantum mechanical and relativistic.
3. A new Force of Nature (de-Broglie Force) was recognized. Strong and Weak Forces were deemed unnecessary.
4. The quantum version of this theory is readily achieved just by eliminating the high mass or short wavelength approximation on equation (103). It is outside the scope of this paper to implement Hypergeometrical Universe Quantum Algorithms. In a fully geometric theory, there are no energy or mass quanta. Motion is quantized by the QLP. All the other quantizations can be recovered from that.

The Hypergeometrical Universe Model provides alternative views on matter and forces by changing the paradigm under which to describe events. The model provides an alternative Standard Model, Cosmology, Cosmogogenesis while maintaining compatibility with Relativity and Quantum Mechanics. The Fundamental Dilator together with the Lightspeed Expanding Universe and the Quantum Lagrangian Principle provides the basis for Quantum Mechanics.

Two fundamental parameters of the universe were calculated from the first principles (permittivity and magnetic susceptibility of vacuum). Universal Gravitational Constant G was also calculated from first principles. G was proposed to be inversely proportional to the 4D radius of the Universe and used to explain implausible Stellar Candle readings.

HU Supernova Analysis brought to light that the **luminosity decay is not dependent directly solely on the Cartesian 4D distance. It is dependent on the number of**

**cycles the dilaton field went through.** That number of cycles is the same, no matter where you are within a hypersphere or epoch.

Using the Quantum Lagrangian Principle to model dynamics naturally bring about the observed speed of light as being the maximum speed in this Universe. It also explains the reason for increased inertial mass and the slowing down of time with speed (increase twisting of local FS). The larger the speed (local FS twist), the smaller the effect of subsequent interactions (accelerations) will be. This allows for a new understanding of the passage of time.

Nuclear lifetimes are also affected by the local twisting. A more detailed analysis is outside the scope of this paper and will be presented elsewhere.

The concept of the Fundamental Dilator brings about a view of a Stroboscopic Universe where interaction is intermittent and where particle substructure is easily explained by the polymeric nature of dilator coherences. It also brings about the possibility of thinking of matter in terms of metric deformations, thus capable of beating and nonlinear hadronic processes. We proposed new experiments that might bring about Coherent Nuclear Fusion along the lines of nonlinear optical interactions. Phase matching angle for coherent hadronic processes is tuned by changing the relative interaction velocity, which is an angle or direction in the 4D spatial manifold.

Gyrogravitation and Electromagnetism Natural Laws were derived from first principles.

The theory was applied to standard tests (Precession of Mercury Perihelion, Gravitational Lensing), was used to explain the Stellar Candle paradox without the use of inflation, Hubble expansion without Dark Energy, Neutron Decay without Electroweak Interaction, Particle Substructure without quark composition and Black Hole's Double Jets with the use of Gyrogravitation. It also provides a potential solution to the Spiral Galaxy rotation problem without the need for Dark Matter.

The Fabric of Space Stress-Strain paradigm applied to the two cross-sections of the Universe (RXYZ and  $\Phi XYZ$ ) allowed for the derivation from first principles of natural laws (Gauss, Biot-Savart, Newton's Gravitation) and the derivation of a more general equation that applies to all forces.

Four Newton's Laws were recast in terms of Stress-Strain relationships. The theory also explains why things move inertially and why the speed of light is a limit.

Newton's Law of Gravitation and Gauss' Law of Electrostatics (also Maxwell equations) were extended to Cosmological distances where it became apparent that the field doesn't decay with distance but with Cosmological Time (number of de Broglie cycles traversed).

For not taking into consideration the HU scenario (or other variants of it) the current interpretation of this Supernova Dataset and the current use of WLR to infer Absolute Luminosities might be systematically overestimating distances. There might be a great benefit from considering epoch dependent G theories, since they challenge the current view of an Inflationary Universe full of Dark Matter and expanded through Dark Energy. The

Hypergeometrical Universe Theory, offering predictions that fit the data on all z ranges, might be a good candidate.

A new paradigm for Dark Matter, antimatter from a Lagging Hypersphere was proposed.

### **3.1 DE BROGLIE FORCE, THE TWO-SLIT EXPERIMENT AND QUANTUM MECHANICS**

The theory proposes a new Force – de-Broglie force by providing a dilaton representation of matter waves. This new force can be used to control particles in the same way as electromagnetism or gravitation, with implications on accelerator design and coherent nuclear fusion reactor architecture. It also explains the self-interference process occurring in a two-slit experiment. The particle rides (and creates) a de-Broglie dilaton field. The particle enters one slit while the dilaton field enter both. The exiting dilaton field from both slits, interfere and guide the particle into the detector in an interferometric pattern. Thus, the electron passing through the two slits is not a good example of a Quantum Process and there is no need to invoke particle-wave duality. Instead, it is a wave-generator, wave interaction process.

This view parallels de-Broglie-Bohm theory with the distinction that wavefunctions are assigned a physical meaning (a propagating deformation of space or the Fabric of Space) and that consideration gives rise to the discovery of a new Force in Nature, so despite of similarities, the perspective unveiled in this theory is distinct and more profound. On the other hand, de-Broglie–Bohm theory dynamics equations fails to provide a comparative framework associating de-Broglie Force Field and other dilatons fields (electromagnetism). They are free particle equations.

The Hypergeometrical Universe also provides an alternative interpretation for the Quantum Mechanics wavefunction as the loci associated with each footprint of the dilators as the Universe expands.

Quantum Mechanics should be recovered from the Hypergeometrical Universe Fundamental Equation without the large-number-of-dilators approximation. It points to a new interpretation of Quantum Mechanics Wavefunctions based on Lissajous interferences in a 5D Spacetime.

### **3.2 SUMMARY**

This is a simple theory in terms of formalism, which provides new insights, proven and testable predictions. A simple mapping from HU Fundamental Dilator based hyperons and isotopes to the Standard Model might be enough to reconcile HU to Quantum Chromodynamics. It also produced extensions of Newton’s and Gauss’ Laws:

$$F_{Gravitational} = G \frac{m_1 m_2}{(\Delta\Phi)^2} \tag{200}$$

$$F_{Electrostatic} = \frac{1}{4\pi\epsilon_0} \frac{C_1 C_2}{(\Delta\Phi)^2} \quad (201)$$

This means that light coming from the past doesn't decay accordingly to the inverse of Cartesian 4D squared distance (see Fig. 30). It doesn't decay with distance AC. It decays with distance AB. That is consistent with HU Quantum Lagrangian Principle and HU ansatz for the dilaton field.

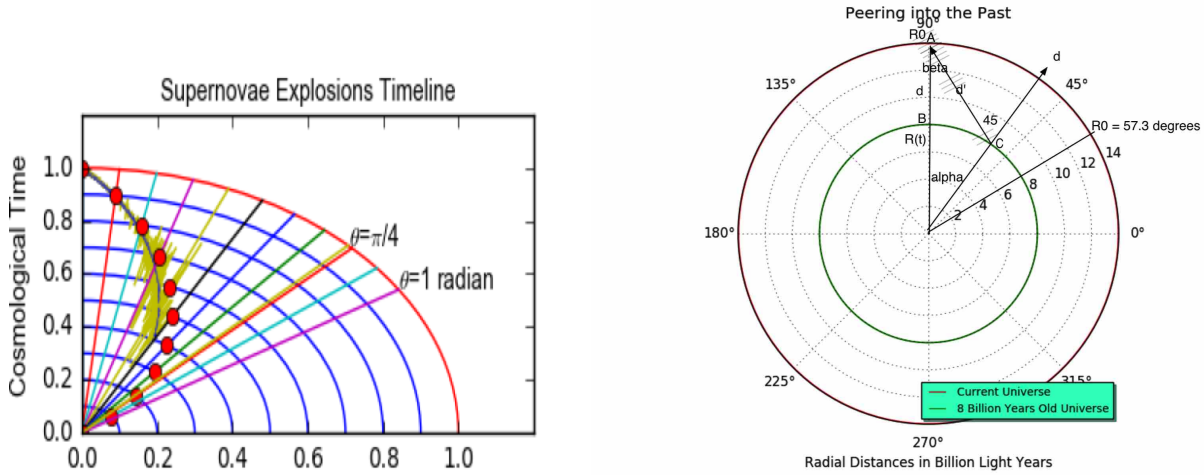

Figure 30. For convenience, we reproduce here the Timeline of SN1a supernova explosions presented as cross-sections of the HU Lightspeed Expanding Hyperspherical Universe.

or more generalized versions:

$$F_{Gravitational} = GM_1 M_2 \frac{1}{\left(1 + \frac{V_1 \cdot \hat{R}}{c} + \frac{V_2 \cdot \hat{R}}{c} + \frac{V_1 \cdot V_2}{c^2}\right) \left(1 + \frac{V_2 \cdot \hat{R}}{c}\right)} \frac{\hat{R}}{(\Delta\Phi)^2} \quad (202)$$

$$F_{Electrostatic} = \frac{C_1 C_2}{4\pi\epsilon_0} \frac{1}{\left(1 + \frac{V_1 \cdot \hat{R}}{c} + \frac{V_2 \cdot \hat{R}}{c} + \frac{V_1 \cdot V_2}{c^2}\right) \left(1 + \frac{V_2 \cdot \hat{R}}{c}\right)} \frac{\hat{R}}{(\Delta\Phi)^2} \quad (203)$$

where  $\Delta\Phi$  is the dimensionalized Cosmological Temporal Distance between the two points in the 4D Universe.

Last, but not least, The Grand Unification Equation:

$$x = \frac{N\lambda_1^2 \lambda_2}{(2\pi)^3 R^2} \quad (204)$$

This new view of reality together with the proposition of the new de-Broglie Force might provide simple solutions to currently intractable problems.

## 4. APPENDICES

### APPENDIX A - VALIDITY TESTS

#### PRECESSION OF MERCURY PERIHELION

Let's consider equation (197) with  $v_1=0$ , that is, body 1 is not rotating. The new potential is given by:

$$V_2(R, V_1=0, V_2) = GM_1M_2 \frac{1}{R \left(1 + \frac{V_2 \cdot \hat{R}}{c}\right)^2} = GM_1M_2 \frac{1}{R \left(1 - \frac{1}{c} \frac{dR}{dt}\right)^2} \quad (205)$$

This is the Gerber's potential which correctly predicts the precession of Mercury perihelion (42.3 arc seconds per century).

#### GRAVITATIONAL LENSING

To calculate Gravitational Lensing one should remember that Electromagnetic Waves are modeled as source-position modulated dilaton fields, that is, EM are dilaton fields (extremely small wavelength = Compton wavelength of a hydrogen atom) modulated by the motion of the dilators that create them. Of course, dilators slow motion yields much larger wavelengths consistent with the electromagnetic waves they generate.

To obtain the predictions of the Hypergeometrical Model for the gravitational refraction of an electromagnetic wave, one should remember that a Force is represented as a Stress in this model. Acceleration is modeled as a local deformation of the Fabric of Space. This is shown in the equation below:

$$F = m_0 c^2 \frac{d \tanh(\alpha_\tau)}{d\tau} = c \frac{d(m_0 v)}{d\tau} = c \frac{d(\hbar k)}{d\tau} = \hbar c \frac{dk}{d\tau} = \hbar c \frac{\Delta k}{\Delta \tau} \quad (206)$$

Where  $d\tau$  is equal to  $cdt$ , that is, it is a dimensionalized time. The momentum of an electromagnetic wave was represented by  $\hbar \cdot k$  and its mass by this equation:

$$m = \frac{\hbar k}{c} \quad (207)$$

Light always travels at  $45^\circ$  with respect to the Fabric of Space. This means that Gravitation only affects the direction of propagation within the Fabric of Space. That cross-section is shown below:

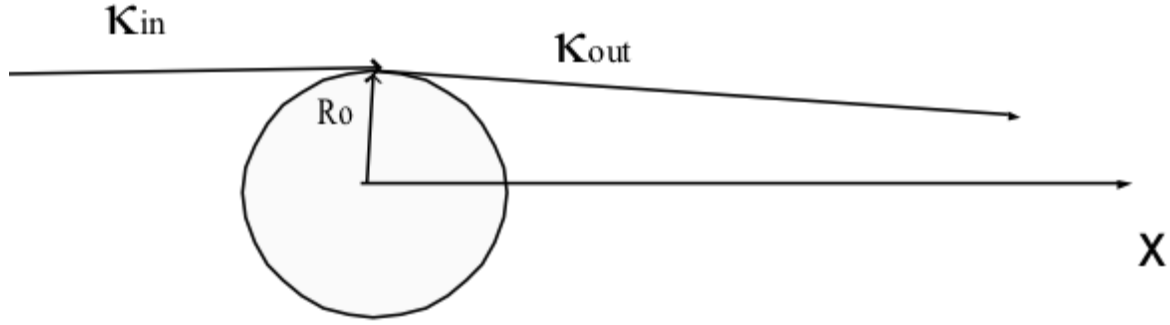

Figure 31. Gravitational induced scattering due to Gravitational Force acting upon a photon.

At the position of scattering  $R=R_0$ ,  $dv/dt=0$  since one cannot increase the speed of light nor decrease it. One can only change its direction within the 3D hypersphere.

The change in direction is shown in the diagram below:

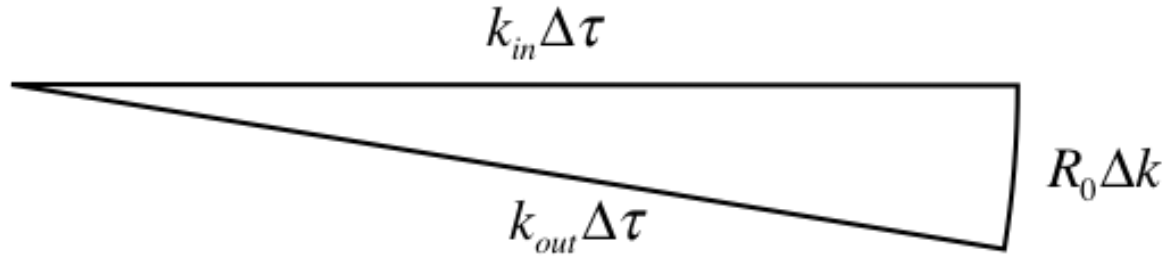

Figure 32. Phase-matching condition on Gravitational Lensing event.

$\Delta\tau$  is the de-Broglie step in the Hypergeometrical Expansion of the Universe. The angle is given by:

$$\alpha = \frac{\Delta k R_0}{k \Delta \tau} \quad (208)$$

The Force can be written in terms of Gravitational fields as:

$$F_2(R, V_2) = -Gm_1 m_2 \frac{\hat{R}}{R^2} \quad (209)$$

The equation of motion for an electromagnetic wave is given by:

$$F = \hbar c \frac{\Delta k}{\Delta \tau} = -Gm_1 m_2 \frac{\hat{R}}{R^2} = -Gm_1 \frac{\hbar k}{c} \frac{\hat{R}}{R^2} \quad (210)$$

From our equation of motion, we obtain:

$$\alpha = \frac{\Delta k R_0}{k \Delta \tau} = \frac{Gm_1}{c^2 R_0} \quad (211)$$

Which is the observed Gravitational Lensing.

## APPENDIX B - SIMPLE TOPOLOGICAL CONCLUSIONS

1. No matter where you are, you are always at the center of your Universe.
2. How Big is Our Visible Universe? The Visible Universe is 13.58 Bly long. Radiation from the Visible Universe is mapped to the 1<sup>st</sup> Quadrant (in Cosmological Angle terms) due to line of sight requirements. Despite of the mapping of the whole visible Universe to the first Quadrant, due to the Universe expansion, we can only explore the first quadrant  $[0, \pi/4]$  and not all the visible Universe  $[0, 1\text{Radian}]$ . Never mind the rest of it  $[1\text{ Radian}, \pi]$ . That part will forever stay invisible and unreachable.
3. How far away are we seeing right now?

The farthest type 1A Supernova in the Survey Union 2.1 is just above 70% of our Universe real 4D Radius ( $0.71R_0$ ).

4. The average radius of curvature of this hypersurface is exactly the speed of light times the age of the Universe, or  $R=13.58$  billion light-years or so. This also explains why the Universe is flat and why the Cosmological constant is very small or zero.
5. The 3D Universe has a radius of curvature equal to the age of the Universe time the speed of light. This radius is independent of mass distribution. Simple symmetry explains why the Gravitationally induced curvature (or Einstein's Cosmological Constant) on  $xyzT$  is also extremely small.
6. The Big Bang occurred on all places at the same time. This is the basis for the non-locality of the Big Bang in a three-dimensional Universe projection. This means that in our Universe, the Big Bang occurred exactly where we are no matter where we are.
7. Due to the topology of a four-dimensional Big Bang, the center of the Universe is a location in the radial direction and not in 3D space.
8. Most galaxies are likely to be at rest with respect to the Fabric of Space, that is, large scale motion should be happening only at Hubble speed.
9. One can see all the way up to the Big Bang (one radian).
10. One can only reach (asymptotically and at the speed of light) a Cosmological angle of  $\pi/4$  (the first Quadrant) due to the Universe expansion.

11. The visible Universe volume is given by  $\frac{4\pi R^3}{3}$ .

12. The whole (Visible plus Invisible) Universe should have a volume of  $\frac{4\pi(\pi R)^3}{3}$ .

13. The actual radius of the Universe is  $\pi R$  or around 42.64 billion light-years.
14. Mach's non-local gravitational interaction explanation for inertia is replaced by a hypergeometrical local fabric of space distortion argument.
15. HU Gravitational Constant  $G$  being inversely proportional to the 4D radius of the Universe, means stronger Gravitation in the earlier epochs.
16. The moving frame aspect of this model requires the actual speed of light to be  $\sqrt{2}c$  since all measurements of the observed speed of light  $c$  can only be done at distances small in comparison to the 4D radius of the Universe.

## APPENDIX C - COHERENT NUCLEAR FUSION

The Hypergeometrical Standard Model provide the means to envision a new process of nuclear fusion where yields are much higher. The conceptual basis for the concept of Coherent Hadronics is the direct result of the fundamental dilator and the hyperspherical expansion universe topology. The fundamental dilator model for matter implies that particles are coherences of a malleable Fabric of Space, and thus can be subject to nonlinear processes.

Current approaches to nuclear fusion uses a nuclear chemistry approach, where a barrier must be overcome for the reaction to occur. The realization that particles could be modeled as coherences, thus similar to electromagnetic waves, allows for a change in paradigm. Instead of overcoming a barrier by extremely high temperatures, we might be able to create the products by fine tuning phase matching conditions in a 4D dynamics space.

The experimental setup for coherent nuclear fusion hadronics would be composed of an accelerator with de-Broglie Force assisted bunching, and magnetic lensing for controlled focusing. Upon focusing at the phase-matching velocity, maximum nuclear fusion yields would occur and nuclear fusion products would be released at the appropriate directions and velocities.

Phase-matching velocity will require the precise measurement of Fabric of Space elasticity tensor. That information is contained in the trove of particle physics decay channels and lifetimes as well as isotope masses and lifetimes. Precise calculation of the appropriate angle will be presented elsewhere.

Another extremely important consideration is that the reactant beams should be polarized. The electromagnetic analogy is that one cannot perform nonlinear optics with scrambled polarization electromagnetic fields.

Careful process optimization should create the same gains one have in nonlinear optics, lowering the breakeven threshold such allowing for smaller reactor and wider applications.

A coherent fusion process would result in the same revolution one had with the invention of nonlinear optics or lasers. The only difference is that in this case it would be the birth of Coherent Nonlinear Hadronics.

Below is the Hypergeometrical Standard Model representation of Deuterium.

Out of a proton and one neutron on can create only one coherence:



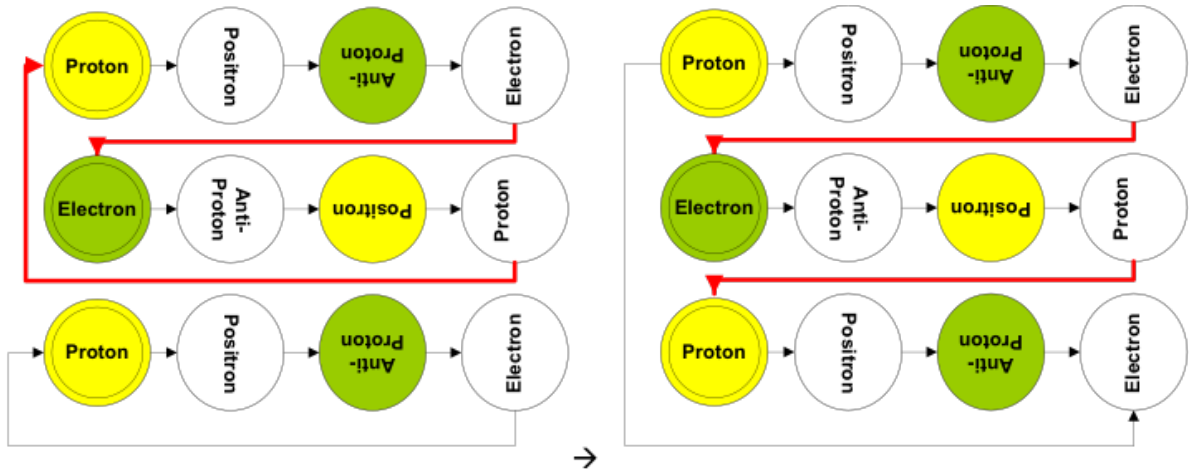

Figure 33. Deuterium diagram.

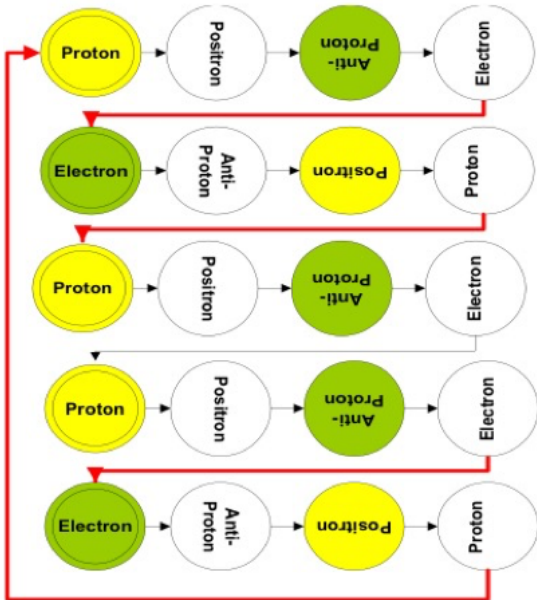

Figure 34. Tritium diagram.

${}^3\text{He}$  has the following configuration:

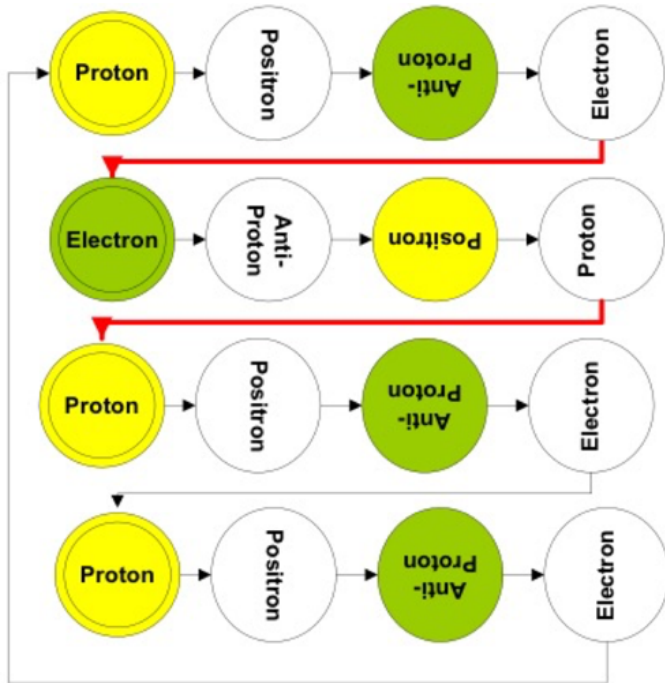
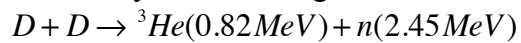

Figure 35. Helium 3 diagram.

Let's study the following reaction:



Where D stands for deuterium and T for Tritium, p for proton. Each channel has a 50% yield under normal fusion conditions.

The advantage of having all charged particle as products is that one can use magneto-hydrodynamics energy extraction. If one can make the products to follow specific directions (directional nuclear fusion), one can use coils to extract energy by induction.

Now we can write the equations:



Figure 36. Nuclear Fusion diagram.  $D + D \rightarrow 3He(0.82 \text{ MeV}) + n(2.45 \text{ MeV})$  (213)

And

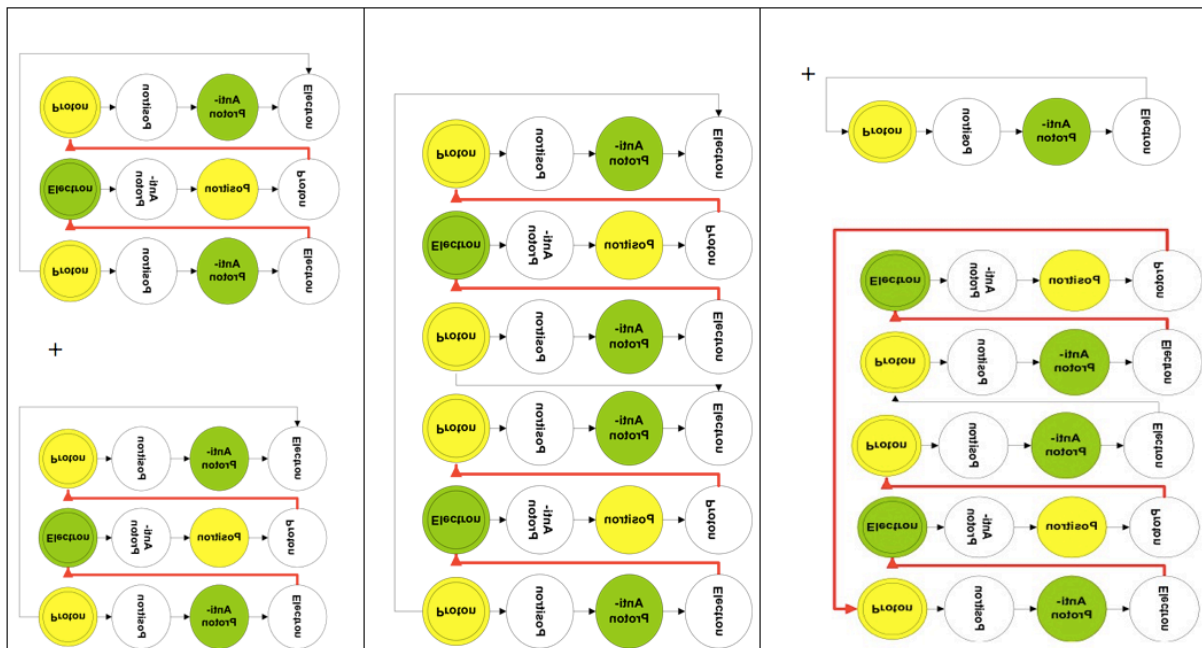

Figure 37. Nuclear Fusion products diagram.  $D + D \rightarrow T(1.01 \text{ MeV}) + p(3.02 \text{ MeV})$  (214)

## Acknowledgements

I would like to thank my Family and Friends for the support they provided throughout my Life.

## Biography



Marco Pereira undergraduate BSEE studies took place at the Instituto Tecnológico de Aeronautica (ITA).

Undergraduate thesis versed on: Extended Hubbard Model Applied to Transition Metal Alloys. Later, Dr. Pereira became a scientist at the Advanced Studies Institute in Brazil. That Institute played a main role in the development of the Brazilian Nuclear Program. Dr. Pereira was asked to study on the applicability of Laser Isotope Separation. Dr. Pereira created a CAD program to design Nonlinear Parametric Oscillators, including the choice of nonlinear crystals and simulated vibronic spectra of transuranic compounds and their dissociation yields.

After finishing his Master Thesis with Distinction, Dr. Pereira joined the Ph.D. Program at the University of Pennsylvania, under the Supervision of Dr. Robin Hochstrasser, a leader in the field of Physical Chemistry. Dr. Pereira soon became a leader in the field of Laser Design, High-Speed/High Voltage Switching, Physical Chemistry, Femtosecond Chemistry. His thesis contained both theoretical modeling (Molecular Dynamics Simulation) and experimental work.

Dr. Pereira took a Post-Doctoral position with Professor Dwayne-Miller at the University of Rochester. There he worked in Ti:Sapphire Laser Amplifiers Design and did forefront research on Molecular Biophysics.

After the post-doctoral position, Dr. Pereira became an Assistant Professor at the Albert Einstein College of Medicine. There he designed from scratch and built a state-of-the-art laser apparatus with double femtosecond Ti:Sapphire Laser Amplifiers, Femtosecond Continuum Generators, Infrared-UV Femtosecond Pulse Generation

Later, Dr. Pereira decided to build a Biotech Company, obtained an MBA at the Leonard Stern School of Business and left Academia. Subsequently, Dr. Pereira worked in M&A, LBOs, Finance and Technology.

Currently, Dr. Pereira teaches Credit Risk Modeling at Rutgers University.

As a side interest, Dr. Pereira created the Hypergeometrical Universe Theory (HU). HU is challenging Cosmology by attacking the way Astronomers measure large distances in the Cosmos – The Type 1A Supernova Survey. The Hypergeometrical Universe Theory allows for the creation of the Current Epoch map of the Universe<sup>18</sup>. That has permitted the creation of a new Cosmogenesis Theory – The Big Pop Cosmogenesis Theory<sup>16</sup>.

## REFERENCES

- (1) Kaluza, T. *Sitzungsber. Preuss. Akad. Wiss. Berlin. (Math. Phys.)* 966--972. **1921**.
- (2) Klein, O. *Zeitschrift für Phys. A.* 37 895--906. *Bibcode1926ZPhy...37..895K. doi10.1007/BF01397481.* **1926**.
- (3) Friedman, A. *Z. Phys. (in Ger.)* 10 377--386. **1922**.
- (4) Schwarzschild, B. *Phys. Today. Vol. 56, No. 4* 21.
- (5) Lach, J. In *Fermilab-Conf-93/381*; 1993.
- (6) Einstein, A. *Ann. Phys.* **1905**, 322 (10), 891--921.
- (7) Pauli, W. *Theory of Relativity*; 1958.
- (8) Jackson, J. D. *Classical Electrodynamics Third Edition*; 1999.
- (9) Hubble, E. *PNAS.* 15 168--173. **1929**.
- (10) Guth, A. H. *Phys. Rev. D* **1981**, 23 (2), 347--356.
- (11) Hoyle, F.; Fowler, W. A. *Astrophys. J.* **1960**, 132, 565.
- (12) Arnett, D. *Astrophys. J.* **1980**, 237, 541--549.
- (13) Lecchini, S. *How Dwarfs Became Giants. The Discovery of the Mass-Luminosity Relation. Bern Studies in the History and Philosophy of Science.*
- (14) Astropy Python Package <http://docs.astropy.org/en/stable/>.
- (15) Supernova Survey Union 2.1  
[http://supernova.lbl.gov/union/figures/SCPUnion2.1\\_mu\\_vs\\_z.txt](http://supernova.lbl.gov/union/figures/SCPUnion2.1_mu_vs_z.txt).
- (16) Pereira, M. Big Pop and Many Bangs Cosmogenesis.
- (17) Pereira, M. Pereira's Github Repository  
<https://github.com/ny2292000/TheHypergeometricalUniverse>.
- (18) Pereira, M. Map of the Universe XYZ  
<https://www.youtube.com/watch?v=ytuEctnD334&t=21s>.
- (19) Pereira, M. Map of the Universe (Declination, RA)  
<https://www.youtube.com/watch?v=YfxqMsnAinE>.

- (20) Gerber, P. *Z. Math. Phys.* 43 , 93--104 **1898**.
- (21) Gerber, P. *Ann. Phys.* 52, 415--444. **1917**.
- (22) Davé, R.; Dubinski, J.; Hernquist, L.; Dave', R.; Dubinski, J.; Hernquist, L. *New Astron.* **1997**, 2 (3), 277–297.
- (23) Bennett, C. L.; Hill, R. S.; Hinshaw, G.; Larson, D.; Smith, K. M.; Dunkley, J.; Gold, B.; Halpern, M.; Jarosik, N.; Kogut, A.; Komatsu, E.; Limon, M.; Meyer, S. S.; Nolte, M. R.; Odegard, N.; Page, L.; Spergel, D. N.; Tucker, G. S.; Weiland, J. L.; Wollack, E.; Wright, E. L. *Astrophys. J. Suppl. Ser.* **2010**, 192 (2), 19.